

III. FAR INFRARED SPECTROSCOPY

Prof. C. H. Perry

A. TECHNIQUES OF FAR INFRARED STUDIES

1. Introduction

The properties of solids in the far infrared part (50-1000 microns) of the spectrum have hardly been explored. In this region lie the resonances of many crystal lattices and excitations of electrons in superconductors, and we may expect to find here other phenomena that are characteristic of collective oscillations in solids, such as resonances of antiferromagnetics and other coupled-spin systems.

The reasons for the deficiencies of spectroscopic technique in this region are well known. The methods of microwave spectroscopy, in which powerful coherent sources are used, of course, have very high sensitivity. There is great difficulty, however, in the progressive extension of the technique to shorter wavelengths. Although sources of 1-mm radiation have been available for some time, the only work thus far reported at wavelengths less than 1 mm has been the accurate determination of frequencies of rotation of certain molecules. This technique employs harmonics derived from sources of radiation in the millimeter range, and a grating can be used with this radiation to sort out the various harmonics, provided that there is enough overlap that an unknown spectrum can be determined over a wide range of frequencies.

The techniques of grating spectrometry with the use of hot untuned sources have been extended beyond 150 μ by various workers.¹⁻⁷ Sensitive detectors are essential because the energy from a hot source falls off rapidly with increasing wavelength (only one part in 10^8 of the total emission of a black body at 10,000°K lying between, say, 150 μ and 350 μ). Furthermore, the energy in the various orders reflected from an echelette grating in a given direction varies as the cube of the order number for unfiltered incident black-body radiation, so that extremely effective filtering is necessary if the intrusion of high-order spectra is to be avoided. In this report improved techniques are described for studying the spectral properties of solids from 373°K down to 4°K, of liquids from 373°K down to 77°K, and the absorption spectra of gases in cells with up to 1-meter path length.

We shall continue investigation of sources, detectors, and filters in order to obtain the maximum performance from the spectrometer. The results thus far obtained will be discussed in the following sections.

Current solid-state research problems include the infrared spectra of perovskite titanates, antiferromagnetic materials, solids exhibiting ferroelectricity, and inorganic compounds that have low internal molecular and lattice vibrations. We propose to investigate materials that show free-carrier absorption and may have electronic transitions in the far infrared at low temperatures (for example, band transitions in semiconductors,

(III. FAR INFRARED SPECTROSCOPY)

and the absorption spectra of some rare earth salts).

2. Design and Operation of the Spectrometer

The design and construction of this spectrometer has been carried out in collaboration with the Spectroscopy Laboratory, M. I. T. A complete remodification of the original long-wave instrument constructed by Lord and McCubbin⁴ has been completed.

The optical design of the spectrometer is illustrated in the ray diagram of Fig. III-1, in which the monochromator unit is shown in conjunction with the low-temperature bolometer. Figure III-2 is a photograph of the far infrared spectrometer. The flexibility of the sample area, A, is illustrated. A modified Perkin-Elmer reflection attachment for reflection measurements at nearly normal incidence is shown intercepting the beam. This can easily be moved and replaced with other solid, liquid or gas sample holders. The kinematically mounted mirror, K, is removable so that a conventional Golay detector, D, can be used for preliminary measurements and low-resolution studies.

The entire spectrometer can be evacuated to remove water vapor that absorbs very strongly in the far infrared. A rough vacuum of 10^{-1} mm Hg is quite adequate for this purpose. The walls, V, are demountable for major adjustments to the optical system, and the slit mechanism, L, and the grating drive, G, are brought out through "O"-ring seals for maximum convenience of operation.

The source, S, is a medium-pressure mercury discharge lamp (General Electric H-4) in a quartz envelope, forming a 1:1 image at position N. A Nernst glower can be located in this position for operating the spectrometer at shorter wavelengths. Rotating crystal choppers of NaCl, KBr, and CsI are used near the focus at position C. They modulate the long-wavelength radiation at 13 cps, are transparent to the shorter wavelengths, and have a relatively sharp change in transmission. A number of radial wires are located in the open section of the chopper to compensate for the dielectric reflection of the crystal, and the diameter of the wires is adjusted to minimize the modulation at short wavelengths. The mirror at position P is kinematically mounted, and can be replaced by a scatter plate, reststrahlen filter or filter grating. A 2:1 magnified image of the source is produced at the entrance slit, W_1 .

The Perkin-Elmer Model 98 monochromator has the grating, G, in the Littrow mounting. An off-axis paraboloid, O, and the entrance and exit slits, W_1 and W_2 , open up to a width of 10 mm. A series of Bausch and Lomb gratings (64 mm \times 64 mm area) is used as dispersing elements, and the gratings are blazed at 444, 333, 222, 89, 44.5, and 22 cm^{-1} ; the 89 cm^{-1} grating is used in both the first and second orders. For use with the Golay detector the three holders, Q_1 , Q_2 , and Q_3 , contain reststrahlen filters BaF_2 , NaCl, KCl, KBr, CsBr, TlBr or KRS-5, the choice depending on the region to be investigated. Normally, only two filters are required; the third is often used for

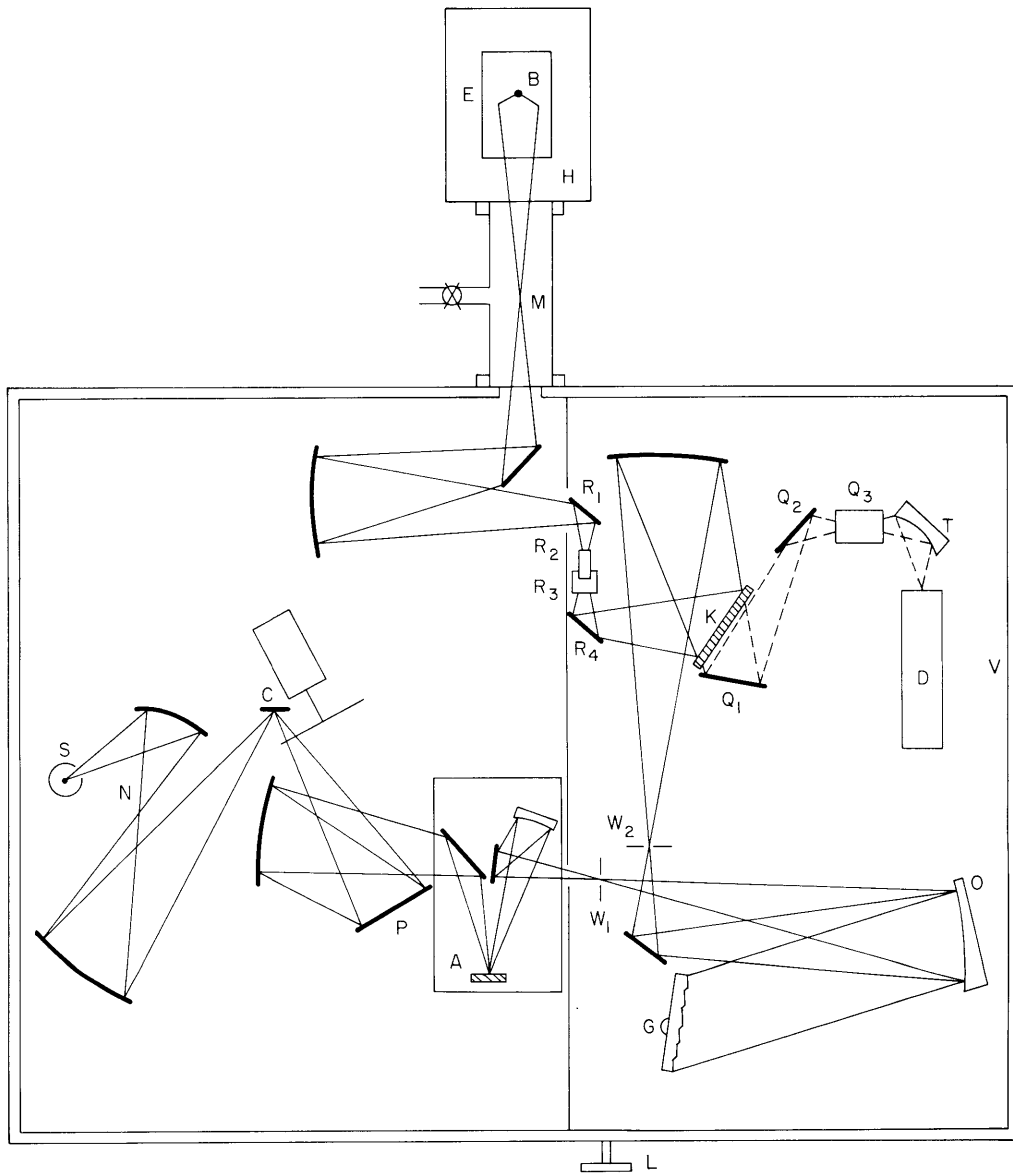

Fig. III-1. Optical layout of the far infrared spectrometer.

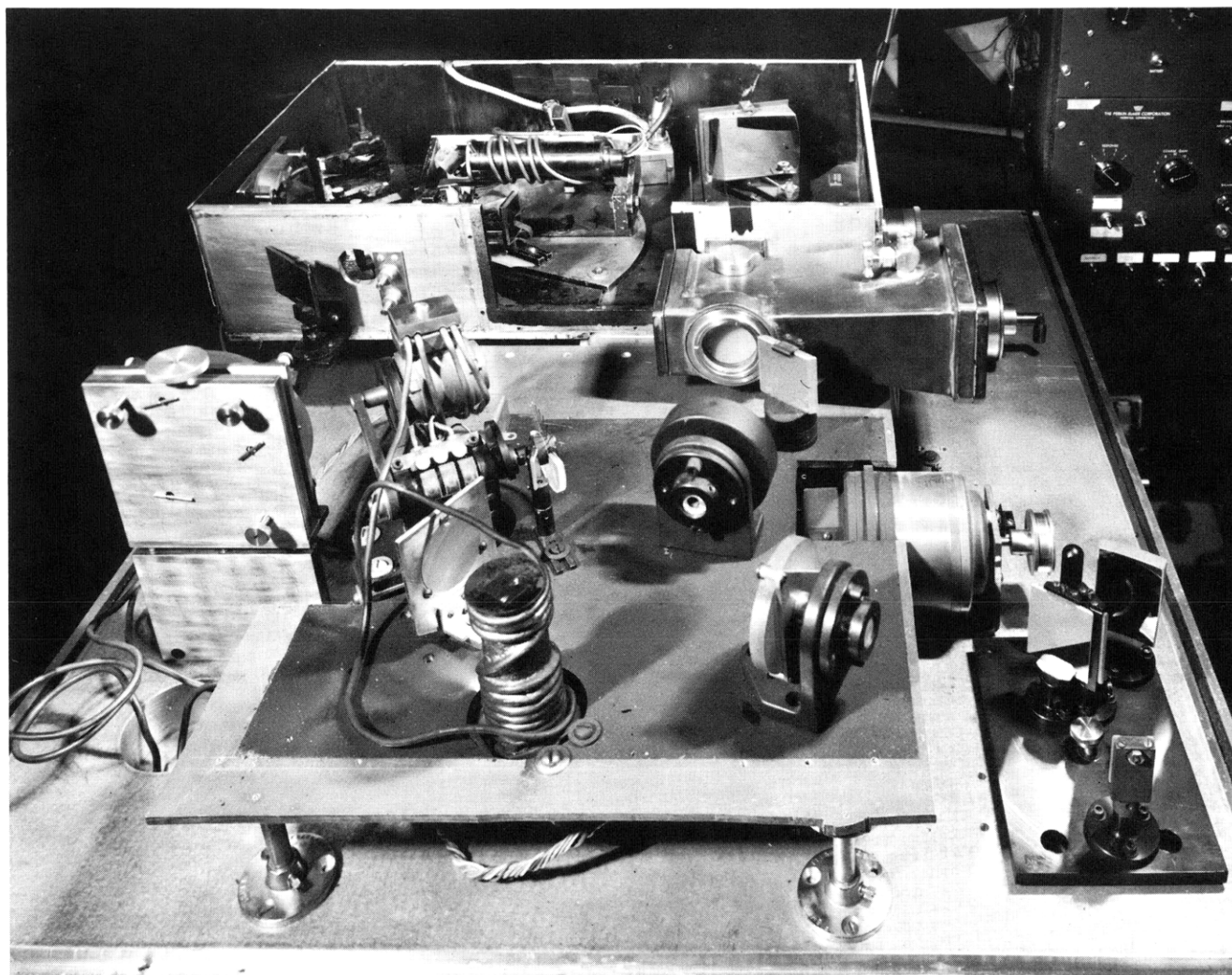

Fig. III-2. The far infrared spectrometer. The 1-meter gas cell is shown in the sample space. The specular reflection attachment has been removed (see Fig. III-1) and is shown at lower right in this picture.

(III. FAR INFRARED SPECTROSCOPY)

reflection measurements at a 45° angle of incidence. Q_2 and Q_3 provide the use of two reststrahlen plates crossed at the polarizing angle in the manner suggested by Czerny⁸ and Strong.⁹ This device is described in a paper by Lord and McCubbin.⁴

Below 50 cm^{-1} no reststrahlen filters are available, and the filtering rests upon zero-order gratings.^{10, 11} These gratings are designed to diffract out of the beam radiation of just shorter wavelength than that required, and the longer wave radiation sees the filter gratings as a series of mirrors and is specularly reflected. Measurements are being made on filter gratings with the lines crossed in three dimensions. This arrangement appears to show considerable improvement in reducing the amount of stray radiation over an arrangement with two gratings in the same plane with the lines parallel to the main grating, G.

With wide slits, carefully chosen zero-order gratings, and the improved detector, the long-wavelength limit should be extended out beyond 600 microns with high hope of reasonably pure radiation.

For use with the low-temperature bolometer, the kinematically mounted mirror, K, allows the beam to traverse the reflection filters or sample holders, R_1 , R_2 , R_3 , and R_4 , (two pairs similar to Q_2 and Q_3). The beam is brought to a focus in the tube, M, outside the instrument, and a 25-cm gas cell can be filled or emptied without disturbing the spectrometer. Polyethylene windows form a seal for the cell at each end. The 90° off-axis ellipse, E, provides a 6:1 image reduction and permits location of the detector, B, and cryostat, H, out of the light beam.¹²

The speed of the instrument is approximately $f/4$ and the usable slit height with the bolometer is 18 mm (12 mm with the Golay detector). Spectra are obtained by automatic recording, the grating being rotated slowly at a rate determined by the resolution and signal-to-noise ratio required. A smoothing circuit is used in the final stage before the pen recorder to give a selection of time constants up to 40 seconds to increase the S/N ratio. With a 25-second time constant approximately 1.5 hours is required to scan the range of one grating – approximately one octave. An automatic system can be used to reverse the sense of rotation, and can be set to allow the instrument to cycle over any particular wavelength range.

In Fig. III-3 the spectrometer that is being used in conjunction with the liquid-helium cryostat is shown (center of picture).

3. Sources

A study of plasma discharges has been carried out to ascertain whether a better source than the conventional H-4 mercury arc could be found for the far infrared. Equipment in the laboratory of the Plasma Physics Group of the Research Laboratory of Electronics was utilized. The initial experiment was a study of a dc plasma discharge in a magnetic field, and an optical system was designed and constructed so that this source

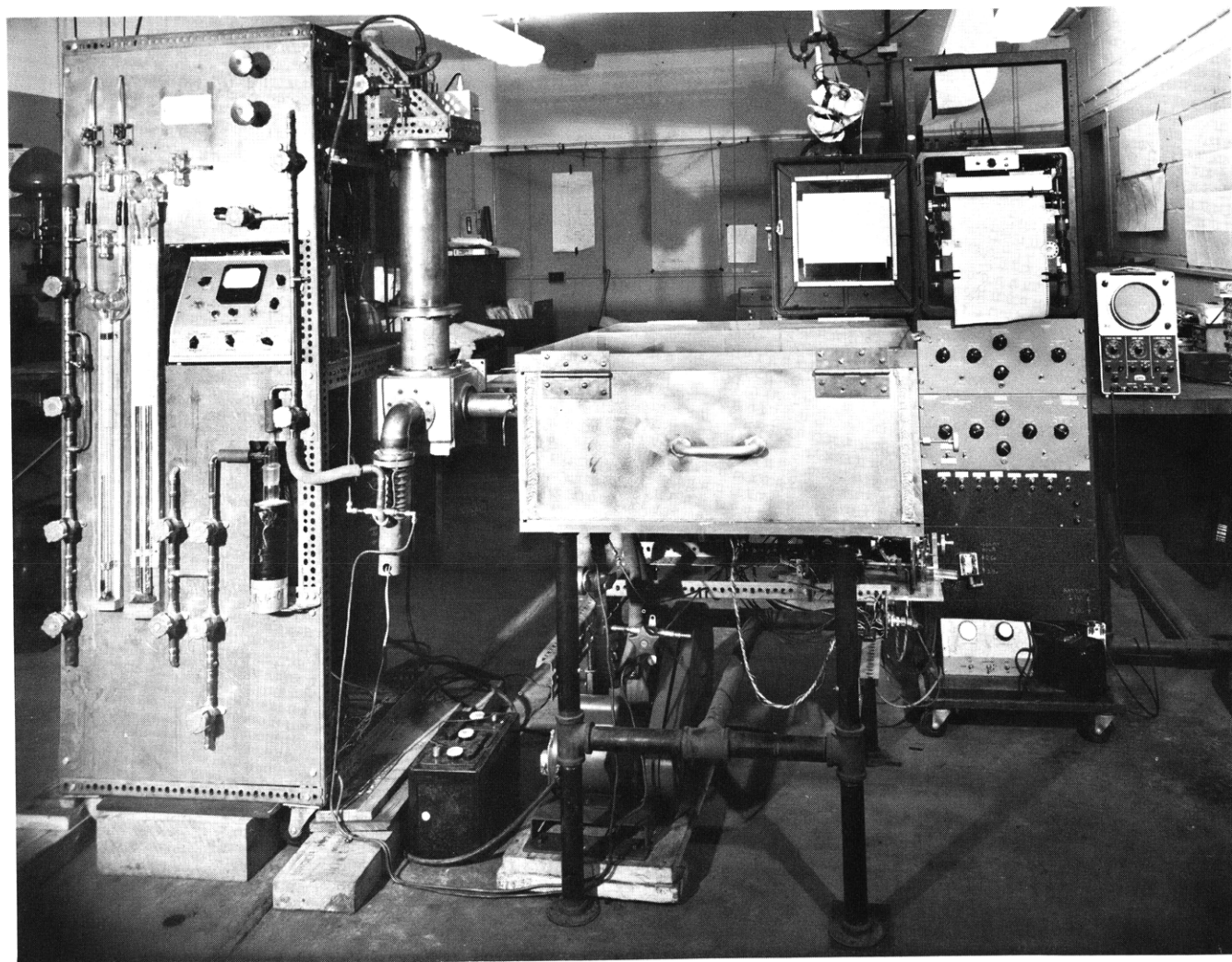

Fig. III-3. Arrangement of helium cryostat, spectrometer, and electronic equipment.

(III. FAR INFRARED SPECTROSCOPY)

could illuminate a grating monochromator with radiation in the range 150-300 microns. A Golay cell (shielded from the magnetic field) served as detector, and two 6.4 ℓ /mm crossed replica gratings were employed as short-wave reflection filters. Additional transmission filters were used to eliminate radiation below 150 μ (black polyethylene, crystal quartz, mica, and a mixture of TlBr and KBr suspended in polyethylene). The source optics were arranged so that an f/2 beam was picked up from the source.

The design difficulties were increased by the fact that the plasma discharge lay along the axis of two Helmholtz coils, the space between which was only approximately 4 inches. The source consisted of a Pyrex tube of 3-in. diameter with a 1-in. crystal quartz window cemented onto a small side arm through which the radiation was collected. The argon discharge was 15 in. long and had a visible diameter of approximately 4 mm. The arc current was varied from 5 amps to 40 amps, and the focusing field from 0 to 1500 gauss. The pressure of argon was varied over the range 1-10 μ Hg, and the flow rate from 30 cc/min to 180 cc/min. None of these factors appeared to affect the far infrared signal within the experimental error of the detecting system. When the discharge was stopped, the signal did not immediately fall, and we concluded that most of the radiation was coming from the hot walls of the Pyrex tube and not from the plasma discharge.

In a second series of experiments a greater depth of the plasma discharge was examined in the absence of a focusing field. Here the discharge tube was 15 in. long with a quartz window on one end, from which the radiation was fed to the spectrometer. The argon-gas pressure was again varied and also the discharge current, but the far infrared signal appeared to be coming mainly from the hot walls of the tube.

A longer discharge, "1 meter" in length, containing four separate cathodes has been constructed and the Plasma Physics Group proposes to vary the discharge current up to approximately 40-50 amps, and to raise the pressure to 10-20 mm Hg in order to make the plasma more opaque. They also propose to repeat the first experiment, using fields up to 50,000 gauss with a simplified optical system in which only transmission filters will be used to eliminate short-wave radiation.

The results of the source studies, thus far, have been very disappointing.

4. Detectors

Most far infrared spectrometers use Golay detectors, which operate at room temperature. The limitation on the detectivity of these devices is set by the intrinsic noise of any device operating at 300°K. Improvement in detectivity beyond this limit can thus be sought only by going to lower temperatures.

During the past year we have placed in operation a liquid-helium cryostat in which an infrared-sensitive detector element can be refrigerated to 1.5°K. The cryostat was designed to be usable with any spectrometer of conventional design, and at present is

(III. FAR INFRARED SPECTROSCOPY)

coupled with the far infrared vacuum spectrometer as shown in Figs. III-1 and III-3. Radiation from the spectrometer is fed to the detector at 1.5°K through a series of three windows at approximately 300°K, 77°K, and 4°K. (See Fig. III-4.) The window

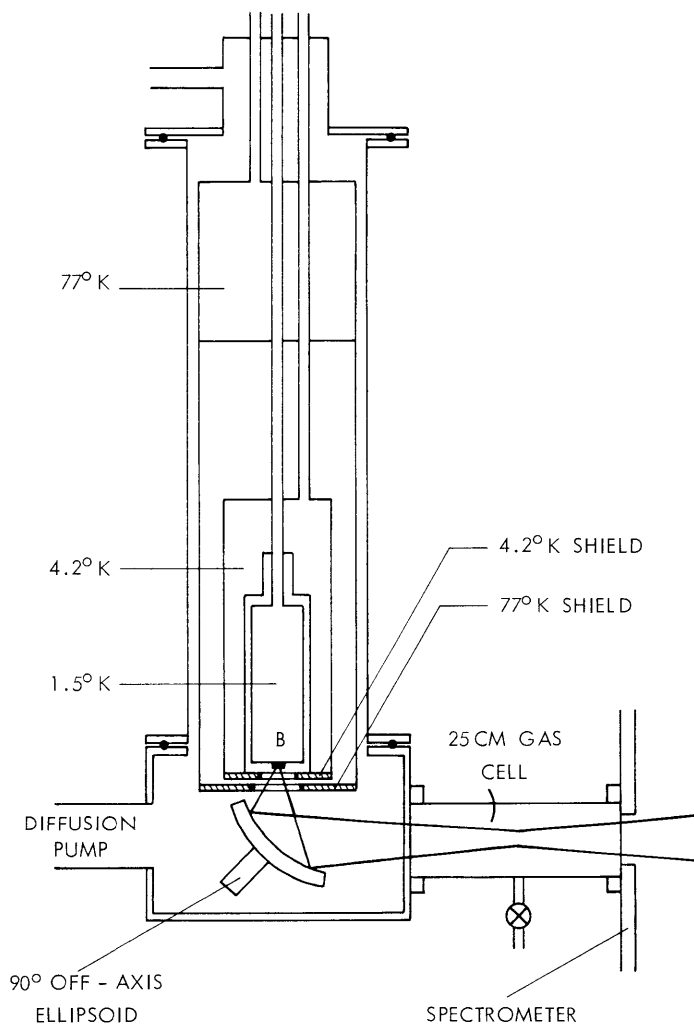

Fig. III-4. Detector optics and cryostat assembly.

materials are chosen to be opaque to radiation of wavelengths less than 40 microns. Thus the detector sees only a small part of the background radiant energy emitted by objects at room temperature in its field of view.

At present, the detector is a graphite bolometer of a fairly standard design.¹³ It is operated at 1.5°K with radiation chopped at 13 cps. The spectrometer is arranged so that the radiation can be sent either to a standard Golay detector or to the cryostat. With this arrangement the performance of the low-temperature bolometer has been

(III. FAR INFRARED SPECTROSCOPY)

compared quantitatively with that of the Golay detector.

Figures III-5 and III-6 show a comparison of the two detectors under the same operating parameters except for temperature. The gain of the Perkin-Elmer Model 107 amplifier was set to give the same throw of the pen on the recorder chart for the same slit widths, electronic time constants, and scanning speeds. Hence, by comparing the peak-to-peak noise, it is possible to assess the relative performance of the two detectors. The carbon bolometer was found to give a signal-to-noise ratio from 8 to 10 times better than the particular Golay detector employed. Boyle¹³ gives a factor of 15 in a similar experiment, but the different figure is certainly within the spread in performance of different Golay detectors.

The improvement over the Golay detector was smaller than expected, but the low-temperature detector is considerably more rugged and stable than a Golay. It is possible to control the sink temperature within less than 0.01°K at 1.5°K quite conveniently by controlling the speed of pumping on the He, so that the zero-level drift is negligible. Continuous cycling between room temperature and helium temperature did not appear to affect the bolometers' performance, and they were quite stable over a particular scan. The detectivity remained approximately constant from run to run, provided the same bolometer current was used. This current was adjusted to give a maximum in the signal-to-noise ratio.

The current noise in the bolometers was comparable to or slightly greater than the amplifier noise, and there seemed to be no great advantage in cooling the load or the grid resistor of the preamplifier (Tektronix 122 or 123).

Recent measurements on a new type of semiconductor bolometer (single-crystal gallium-doped germanium) showed that it was advantageous to cool both input resistors to reduce Johnson noise. Preliminary measurements for far infrared detection on this type of bolometer proved quite promising. The properties of germanium are even better than carbon at low temperature, since the thermal conductivity of germanium is approximately three times that of carbon, and consequently the thermal relaxation time depends only on the thermal time constant of the leads. This means that higher chopping frequencies could lead to a reduction in 1/F noise and also to an increase in the scanning speed without loss of responsivity and consequent loss in resolution. Low¹⁴ reported time constants as low as 0.5 msec with an N. E. P. of 5×10^{-13} watt at a chopping frequency of 200 cps.

The doped germanium absorbs about 70 per cent of the incident far infrared radiation. This result was obtained by making transmission and reflection measurements at the same time on a sample at a temperature less than 2°K with two carbon bolometers at right angles to one another and with the germanium specimen set at 45° to the incident beam. (See Fig. III-7.)

The germanium bolometer has an even lower response in volts/watt than the carbon

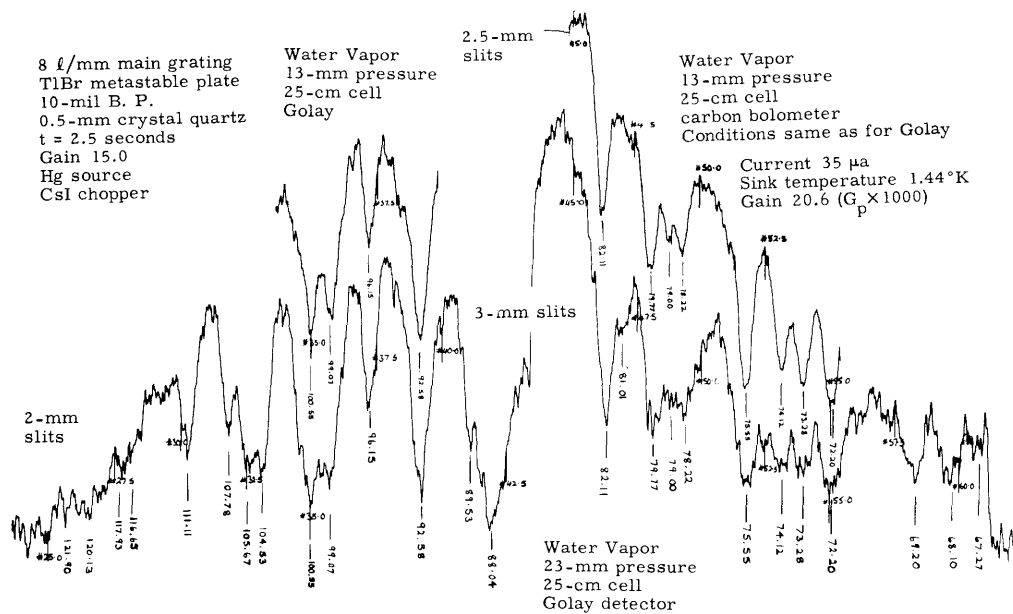

Fig. III-5. Infrared absorption spectrum of water vapor taken with carbon-resistance bolometer at 1.5°K (upper curve) compared with Golay detector at room temperature (lower curve). Note the clear resolution of the water triplet at 78.22, 79.00, and 79.77 cm^{-1} obtained with the low-temperature detector.

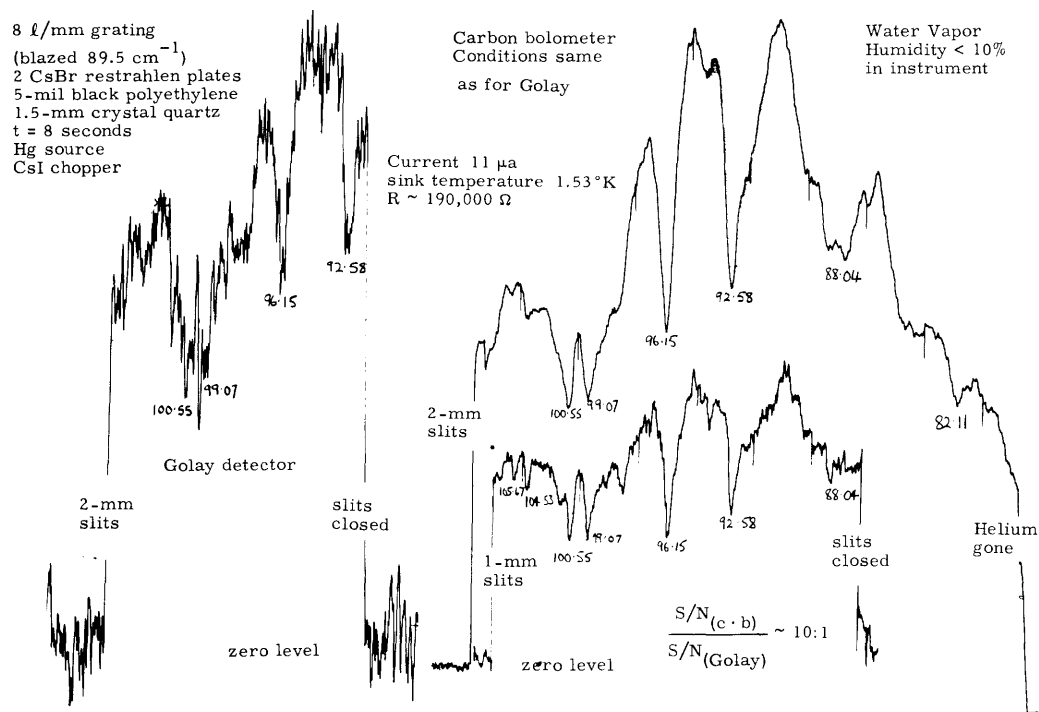

Fig. III-6. Comparison of signal-to-noise ratios for carbon bolometer (upper right curve) and for Golay detector (left curve). Lower right curve shows increased resolution with narrower slits for the carbon bolometer. Note small band now resolved on the side of the 100.55 cm^{-1} band as compared with the upper trace.

(III. FAR INFRARED SPECTROSCOPY)

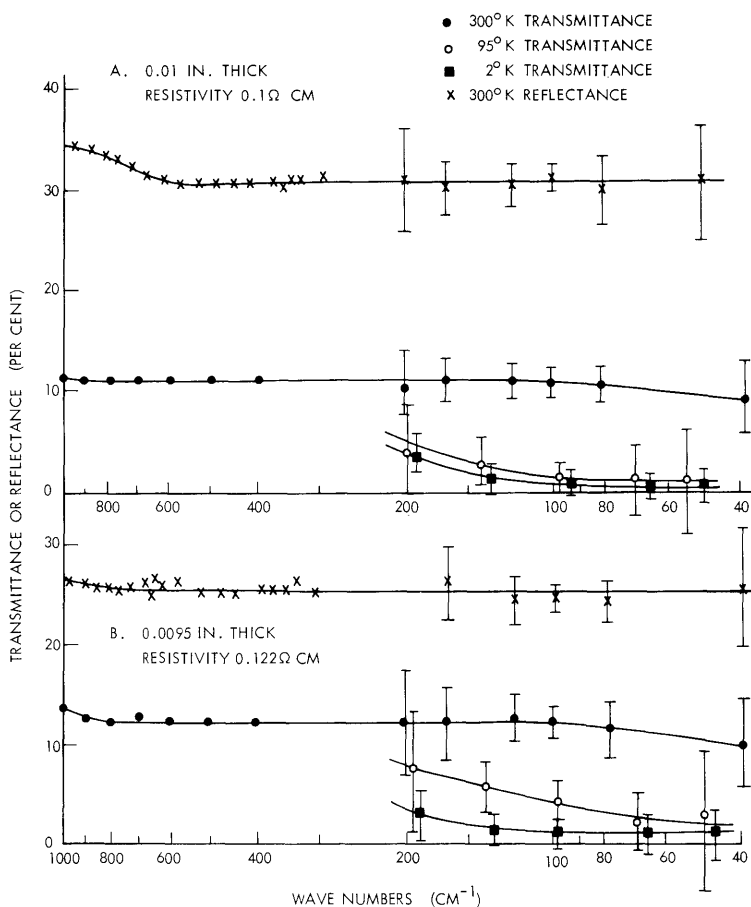

Fig. III-7. Transmittance and reflectance curves for two gallium-doped germanium bolometers (1000-40 cm^{-1}).

bolometer and, although the inherent noise in the germanium bolometer is probably lower, more gain is needed in the preamplifier and the preamplifier noise (flicker noise in the tubes, etc.) may well set the lower limit of the minimum detectable signal.

Work will continue on the improvement of both types of bolometer. At present, their performance is less spectacular than we had anticipated, but, with continued effort, we hope to increase the factor of superiority over the Golay detector to the two orders of magnitude to be expected from the ratio of operating temperatures.

5. Filters

Considerable progress has been made during the year in the critical area of filter development. The most important filters have been the reflection filters.

For many years, the residual-ray reflection properties of crystals have been used to eliminate short-wave radiation. We have found for the first time that thallium

(III. FAR INFRARED SPECTROSCOPY)

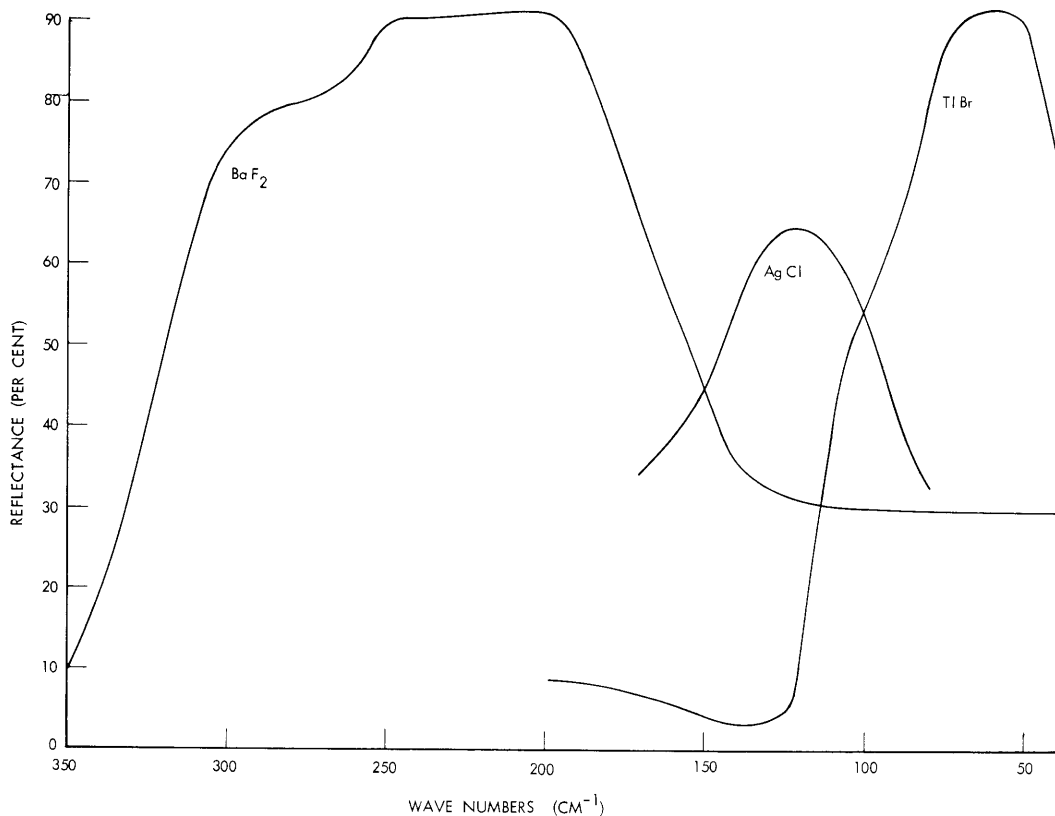

Fig. III-8. Reflectance curves for BaF₂, AgCl, and TlBr.

bromide removes radiation above 110 cm^{-1} quite effectively, yet has high reflectivity throughout the octave from 55 cm^{-1} to 110 cm^{-1} . Below 60 cm^{-1} , thallium bromide ("KRS-5") is somewhat better, although its lower limit is hardly less than that of TlBr. Silver chloride and barium fluoride have been found to reflect very well in the ranges $110\text{-}150$ and $225\text{-}350\text{ cm}^{-1}$, respectively. (See Fig. III-8.)

Below 50 cm^{-1} (down to approximately 20 cm^{-1} , the practical lower limit on our present equipment with the Golay detector), reflection filters made from a Bausch and Lomb magnesium grating of 4 grooves/mm and replicas of a 6.4-grooves/mm grating ruled at the University of Michigan have worked quite effectively. With such gratings used in the crossed orientation, less than 10 per cent stray radiation is present in the range $35\text{-}55\text{ cm}^{-1}$. Comparable performance with these or other grating filters is expected below 35 cm^{-1} , but studies of stray radiation in this region are still under investigation.

B. SOME SOLID-STATE STUDIES IN THE FAR INFRARED

The infrared spectra of three perovskite titanates have been observed from $4000\text{-}30\text{ cm}^{-1}$ ($2.5\text{-}330\text{ }\mu$) in both transmission and reflection. The spectra show a number

(III. FAR INFRARED SPECTROSCOPY)

of absorption bands that can be interpreted as the frequencies of the spectroscopically allowed normal modes of vibration of these materials. In all three titanates an additional infrared active vibration is observed which has not been reported previously. The value of the lowest vibrational frequency responsible for the ferro-electric behavior of these materials is estimated from a Kramers-Kronig (K-K) treatment of the reflection data. There appears, however, to be disagreement between reflection measurements made on these crystals at 5 cm^{-1} with millimeter wave techniques at Lincoln Laboratory, M. I. T., and our results down to 30 cm^{-1} with conventional infrared techniques. As the low-frequency band obtained from the K-K analysis is very dependent on the extrapolation to 0 cm^{-1} , the Lincoln Laboratory results will be repeated at 5 and 10 cm^{-1} before the data are complete.

Crystalline K_2PtCl_4 , suspended in polyethylene, has also been studied in transmission from 400 cm^{-1} to 50 cm^{-1} ($25\text{-}200\ \mu$), and the allowed infrared active vibrations have been assigned. This work is being extended to other related compounds with the same crystal structure.

The author is grateful to Professor R. C. Lord for his advice and encouragement of this research, and he wishes to thank Dr. G. R. Hunt, Dr. B. N. Khanna, and other members of the Spectroscopy Laboratory, M. I. T., for their cooperation in this project.

C. H. Perry

References

1. T. K. McCubbin, Jr. and W. M. Sinton, *J. Opt. Soc. Am.* **40**, 537 (1950).
2. R. A. Oetjen, W. H. Haynie, W. M. Ward, R. L. Hansler, H. E. Schauwecher, and E. E. Bell, *J. Opt. Soc. Am.* **42**, 559 (1952).
3. L. Genzel and U. W. Eckhardt, *Z. Physik* **139**, 578 (1954).
4. R. C. Lord and T. K. McCubbin, Jr., *J. Opt. Soc. Am.* **47**, 689 (1957).
5. M. Yoshinaga, S. Fujita, S. Minami, A. Mitsuishi, R. A. Oetjen, and Y. Yamada, *J. Opt. Soc. Am.* **48**, 315 (1958).
6. T. J. Dean, G. O. Jones, D. H. Martin, P. A. Mawer, and C. H. Perry, *Physica Suppl.* **24**, 151 (1958).
7. D. Bloor, T. J. Dean, G. O. Jones, D. H. Martin, P. A. Mawer, and C. H. Perry, *Proc. Roy. Soc. (London)* **A260**, 510 (1961).
8. M. Czerny, *Z. Physik* **16**, 321 (1923).
9. J. Strong, *J. Opt. Soc. Am.* **29**, 520 (1939).
10. J. U. White, *J. Opt. Soc. Am.* **37**, 713 (1947).
11. R. F. Stamm and J. J. Whalen, *J. Opt. Soc. Am.* **36**, 2 (1946).
12. C. C. Helms, H. W. Jones, A. J. Russo, and E. H. Siegler, Jr., *Spectrochimica Acta* **19**, 819 (1963).
13. W. S. Boyle and K. F. Rodgers, *J. Opt. Soc. Am.* **49**, 66 (1959).
14. F. J. Low, *J. Opt. Soc. Am.* **51**, 1300 (1961).

