

Introduction to Transportation Systems

PART II:

FREIGHT

TRANSPORTATION

Chapter 14:

Railroad Operations

Path from Shipper to Receiver

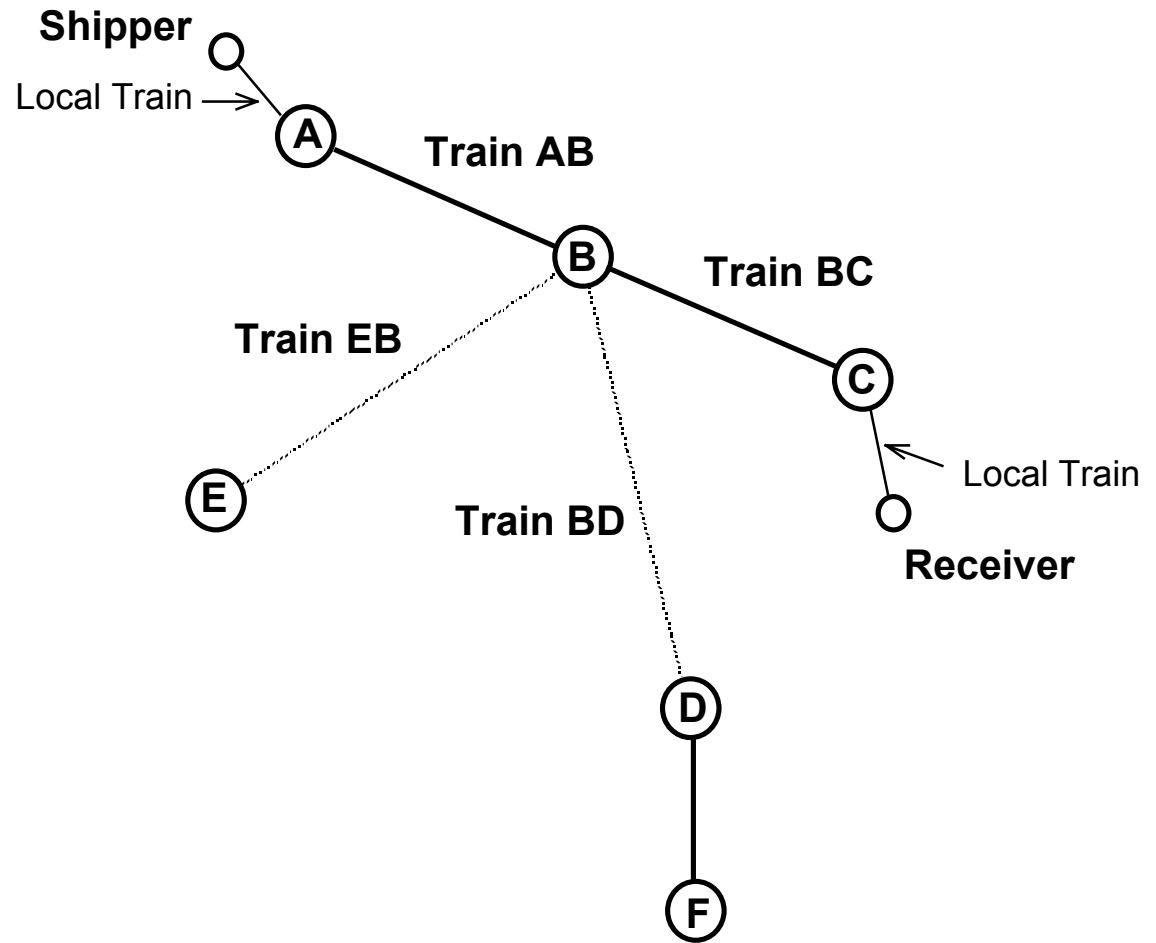

Blocking Patterns

Train AB



Train EB



Train BC

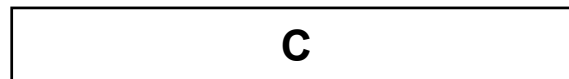

Train BD



D and F randomly ordered

or



D and F traffic is blocked

Consolidation

- ◆ A Key Concept: Consolidation
- ◆ The railroad system is a high fixed cost system.

Take traffic from E and A destined for C and block it into a single set of cars that will go together from B to C at presumably lower cost than in the case of A-C and E-C traffic going separately.

Train Operating Costs vs. Train Length

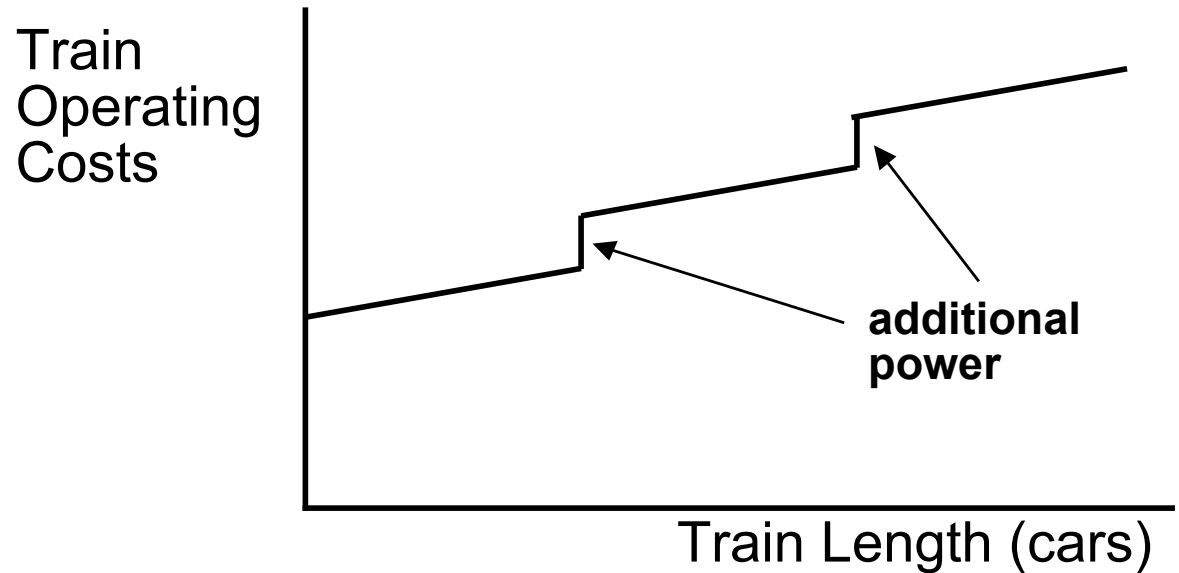
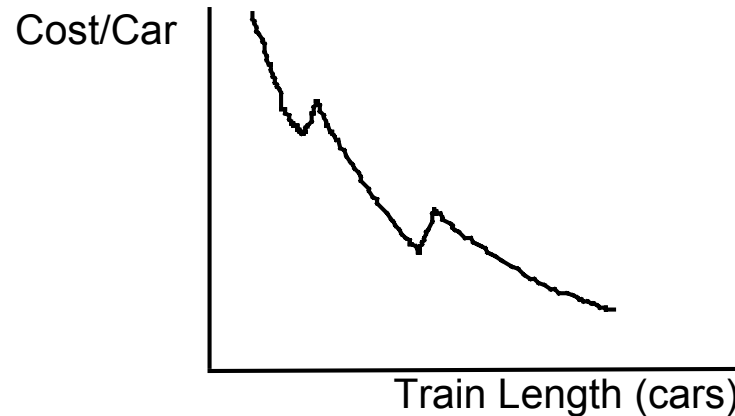

Figure 14.3

- ◆ The operating policy to generate cost savings through consolidation implies stiff penalties when things go wrong. The reason that we run only one train a day from B to C is to achieve long train lengths.
- ◆ Often we operate with 24-hour service headways; if the cars from E to B destined for this outbound train going to C misses that connection for whatever reason, this can cause a 24-hour delay until the next train.
- ◆ Think about the impact of these delays on the total logistics costs of the affected receivers. Perhaps a stock-out for our customer results.

Cost/Car and Train Length



- ◆ The cost per car on a long train is clearly going to be much lower than the cost per car on a short train. So there is an incentive to run longer trains from a cost view; that is what drives the idea of low train frequency.
- ◆ If we run two trains a day between B and C with 50 cars on each rather than 1 train with 100 cars, there is a higher level-of-service associated with a higher train frequency; however, from a cost point of view it is more expensive to run two 50-car trains rather than one 100-car train.

Figure 14.4

Operations vs. Marketing Perspectives

- ◆ Now this simple idea relates to “tension” between the operating and the marketing people. Who is going to want to run the 100-car train? The operating person or the marketing person? And who is going to want to run the two 50-car trains?

CLASS DISCUSSION

Train Dispatching

Dispatching Choices

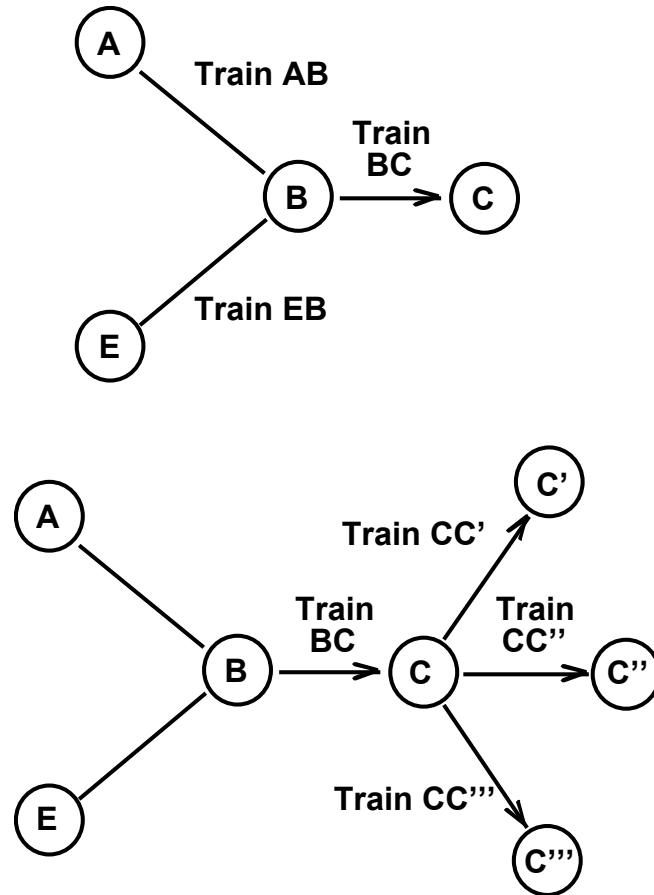

Figure 14.5

A Choice in Dispatching

Do We “Hold for Traffic”?

- ◆ Delay Propagation on Networks
- ◆ Network Stability

Stable vs. Unstable Equilibrium

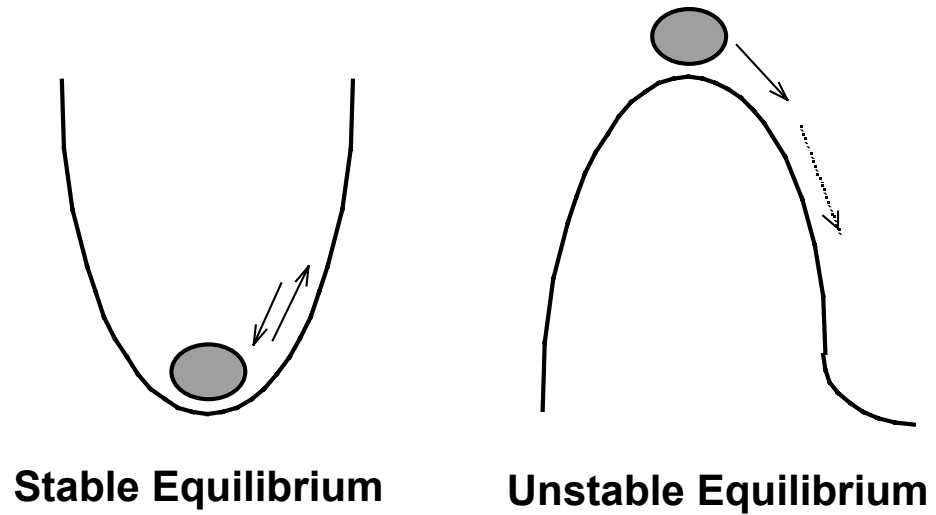

Figure 14.6

Operating Plan Integrity

- ◆ Why don't the railroads just run the trains on schedule as an optimal strategy?
- ◆ The basic notion is design an operating plan that is feasible and makes sense. You have enough power; you have enough line capacity; you have enough terminal capacity to make this plan actually work.
- ◆ You run the trains according to plan, that is, according to schedule.

“Scheduled” vs. “Flexible” Operation

- ◆ Is the best strategy “running to plan” in a disciplined manner?
- ◆ Some railroads feel that is an inflexible, uneconomic way of running the system.
- ◆ These railroads feel that flexibility for the terminal managers is useful and they can do a better job of balancing service and costs than they can by inflexibly “running to plan”.

A Framework for Transportation Operations

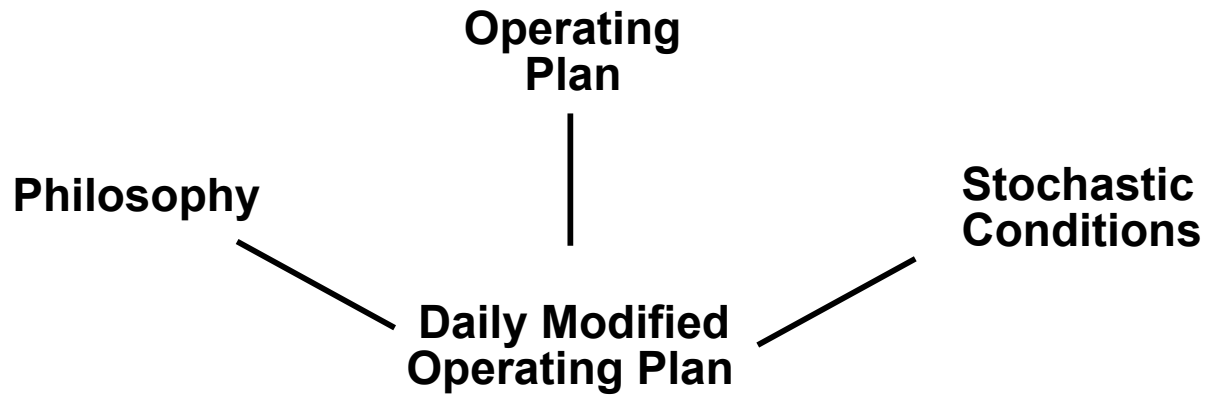

“Daily Modified Operating Plan”

- ◆ Suppose we have developed, through optimization methods, an “operating plan” which governs the network.
- ◆ Suppose each day at 6 a.m., railroad management takes that operating plan and from it produces a *daily modified operating plan* which governs the way the railroad will operate *on that particular day*.
- ◆ The operating plan is a base case; the *daily modified operating plan* is a plan of action for a particular day.
- ◆ The daily modified operating plan takes account of stochastic conditions on the network like weather and traffic conditions.
- ◆ It also reflects how much a railroad is willing to change that base operating plan to accommodate conditions on a particular day.

How to Define Scheduled vs. Flexible Railroads?

- ◆ The first way: A scheduled railroad would be one in which *the operating plan and the daily modified operating plan were exactly the same.*
- ◆ The second way: A scheduled railroad is one in which there is no difference between the daily modified operating plan decided upon at 6 a.m. and what they *actually do that day.*