

JULY 1987

LIDS-P-1678

MEASURES OF EFFECTIVENESS AND C3 TESTBED EXPERIMENTS*

by

Philippe J. F. Martin**
Alexander H. Levis***

ABSTRACT

A methodology for evaluating a large scale C³ system is developed. The first step of this methodology consists of a procedure for evaluating a system using a simple model of it. The second step consists of an algorithm aimed at determining the smallest number of experiments that will enable one to evaluate the effectiveness of an actual C³ system or testbed.

This methodology is applied to an abstracted version of an actual air defense system: a mathematical model of this system is presented and the system is evaluated on the basis of this model. The experiment design procedure is assumed to have been implemented and data produced; it is then shown how the actual system would have been evaluated based on these data.

*This work was conducted at the MIT Laboratory for Information and Decision Systems with support by the French Delegation Generale pour l'Armement and with partial support provided by the Joint Directors of Laboratories through the Office of Naval Research under Contract No. N00014-85-K-0782.

**TSI, AMX-APX, 78013 Versailles, FRANCE.

***Laboratory for Information and Decision Systems, MIT, Cambridge, MA.

MEASURES OF EFFECTIVENESS AND C³ TESTBED EXPERIMENTS*

Philippe J.F. Martin

TSI, AMX-APX
78013 Versailles
FRANCE

Alexander H. Levis

Laboratory for Information and
Decision Systems, MIT
Cambridge MA

ABSTRACT

A methodology for evaluating a large scale C³ system is developed. The first step of this methodology consists of a procedure for evaluating a system using a simple model of it. The second step consists of an algorithm aimed at determining the smallest number of experiments that will enable one to evaluate the effectiveness of an actual C³ system or testbed.

This methodology is applied to an abstracted version of an actual air defense system: a mathematical model of this system is presented and the system is evaluated on the basis of this model. The experiment design procedure is assumed to have been implemented and data produced; it is then shown how the actual system would have been evaluated based on these data.

I. INTRODUCTION

A major focus of the research in Command and Control (C²) is the need to assess quantitatively the utility of Command, Control, and Communications (C³) systems. Over the past decade, methodologies have been proposed that provide system developers with powerful tools for evaluating the effectiveness of systems [Mishan 1976, Dersin and Levis 1981, White 1985]. All these methodologies assume that experimental data can be gathered for the system to be evaluated.

A new problem arises when very large scale economic, social or military systems are considered because it is often not possible to run a large number of experiments and collect all the data necessary to carry out the assessment. A common approach to analyse and evaluate system design is to build a test bed which provides the developer with the ability to consider many different configurations of the same system and with a means to gather data on these configurations in order to evaluate them. However, for each configuration of the system, one must design experiments to run in order to obtain data.

In response to this need, a methodology is presented in this paper: it aims at the design of experiments to run on a system so that the effectiveness of any configuration can be evaluated. This methodology draws on the framework first developed by Dersin and Levis (1981), and then applied to C³ systems by Bouthonnier (1984), and Cothier (1986). The method of analysis used is based on relating the performance of a system to the requirements of the mission it has to fulfill.

*This work was conducted at the MIT Laboratory for Information and Decision Systems with support provided by the French Delegation Generale pour l'Armement and with partial support provided by the Joint Directors of Laboratories through the Office of Naval Research under Contract No. N00014-85-K-0782.

II. SYSTEM EFFECTIVENESS ANALYSIS

Let us consider a set U which represents the universe: U will be called the universal set. It may contain a great diversity of elements such as physical entities, data bases, or doctrines. A goal is defined to be a particular desired state of the universe U. Typical goals are : to produce data, to transmit information, or to defend one's assets. A *system* S is defined to be a set of elements of the universe U that **act together** by exchanging information (connectivity) toward the achievement of a particular *goal*. The set S is a subset of U. An element u of the universe is included in the *environment* E if and only if u does not belong to S and the system can act upon u, and u can act upon the system. The *context* C then is defined as the complement of the set $S \cup E$ in the universe (" \cup " denotes the union of two sets, and " \cap " their intersection). With these three definitions one can easily deduce the following properties:

$$U = S \cup E \cup C, \quad S \cap E = \emptyset, \quad S \cap C = \emptyset, \quad E \cap C = \emptyset \quad (1)$$

The term *mission* designates the task the system has to perform. It is the particular state of the environment that has to be achieved by the system. The mission depends on the system considered: for instance, the mission of a C³ system is to provide "adequate" information to effectors on the basis of the data it receives from the sensors.

Parameters are the independent variables in system effectiveness analysis. The system parameters are entities whose value determine system behavior and specify system structure. They are defined **within** the system boundary. Environment or context parameters refer to the independent variables that describe the environment or the context.

Measures of Performance (MOPs) are measurable quantities that describe system properties or attributes. Their values depend on the values of the parameters that characterize the system, the environment, and the context. The system measures of performance vary in Ω , a subset of R^n where n is the number of MOPs. Since the parameters are constrained to be in a subset P of R^p where p is the number of parameters, one cannot expect the MOPs to take any value in Ω . Since each MOP is a function of several parameters, one can define a mapping from the parameter space into the MOP space. This mapping is obtained by exercising the system (or by running simulations) for different contexts and different values of the system parameters in order to generate the reachable MOP values. The set of this reachable MOP values is the system locus L_S (Fig.1).

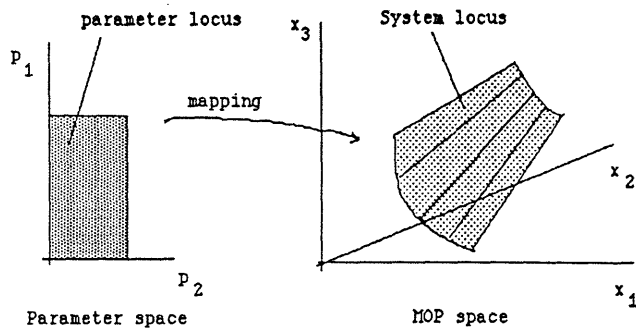

Fig.1 System Locus

The mission the system has to achieve is defined by requirements in the MOP space. These requirements are obtained by running models, games or plans for different contexts and for different mission parameters. In order to enable one to compare the mission and the system, the requirements must be expressed in term of the MOPs defined for the system: the mission MOPs (expressing the mission requirements) must be the same as the system MOPs (expressing the system capabilities). The set of MOP values that satisfy the mission requirements constitutes the mission locus L_m (Fig.2).

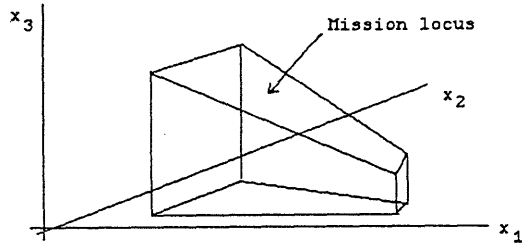

Fig.2: Mission locus

Some *Measures of Effectiveness* (MOEs) can be derived from the comparison of the two loci L_s and L_m . Qualitatively, the greater the intersection of the two loci, the more effective the system is. If $V(L)$ is a measure on the locus L (Fig.3), one can define the following MOEs:

$$E_1 = V(L_s \cap L_m) / V(L_s) \quad (2)$$

$$E_2 = V(L_s \cap L_m) / V(L_m) \quad (3)$$

where E_1 is the degree to which the system capabilities are included in the mission locus (it measures how well the system capabilities are used for the mission considered) and E_2 is the degree to which the mission locus is covered by the system (it is the degree of coverage of the mission by the system.)

The important fact in the passage from an MOP to an MOE is the consideration of requirements: In the absence of requirements, the system locus cannot tell how effective the system actually is.

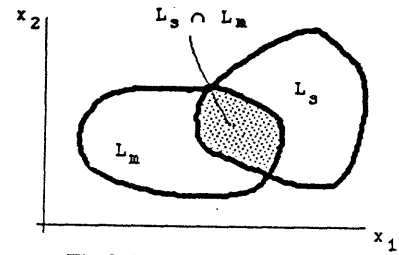

Fig.3: Measures of effectiveness

For a given system, one can define many different MOEs representing effectivenesses from various standpoints: These MOEs are called partial MOEs. Let E_1, E_2, \dots, E_p be the partial MOEs for a given system. Debreu [1968] has shown that, under certain conditions, there exists a real valued function, a utility function, which is continuously dependent on the E_i . Let U be such function taking values between 0 and 1:

$$[0,1]^p \text{ -----} \rightarrow [0,1]$$

$$E_1, E_2, \dots, E_p \text{ -----} \rightarrow U(E_1, E_2, \dots, E_p)$$

then, the global measure of effectiveness can be taken to be $U(E_1, E_2, \dots, E_p)$.

The System Effectiveness Analysis methodology presented in this section is used now to design experiments to run on large scale systems so that these systems may be improved.

III. EXPERIMENT DESIGN FOR LARGE SCALE SYSTEMS

To determine the system locus of a large scale system requires, in general, operating the system at an extremely large number of sets of parameter values. The procedure presented in this section provides a means for determining only a small set of experiments to be run on the system: the resulting small number of experimental values will be combined with the results obtained from a simplified mathematical model of the system to construct the system locus of the actual system.

A simplified mathematical model of the actual system is first considered; this model can be represented by a mapping "f" from the parameter space into the MOP space. Two mappings, and consequently two loci can be considered. First, using the mathematical model "f", the parameter space can be mapped into the "model" system locus. Second, the actual system, if it could be exercised for all the values of the parameter space, would yield the "actual" system locus (Fig.4). Since the model is a simplified one, the model locus is a rough approximation of the actual locus.

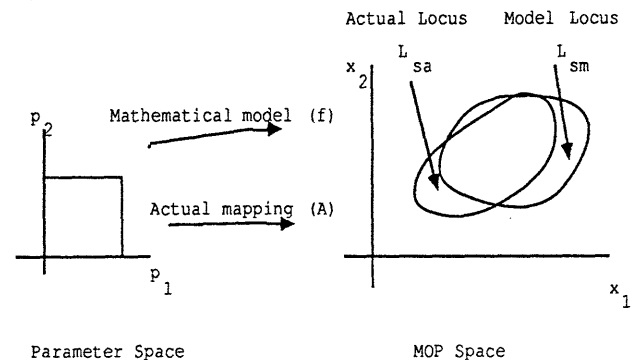

Fig.4 Actual and Model System Loci

Since the objective is to determine the actual locus, the key idea is to obtain the model locus, and a few points of the actual locus, and to determine a mapping "T" that transforms the model locus into the actual locus in the MOP space. With this mapping, the actual locus can be obtained indirectly: if "A" is the actual mapping from the parameter space into the MOP space, then $A = T \circ f$, where "o" denotes the composition of two functions (Fig.5). With this algorithm, only a few points belonging to the actual locus, and therefore only a few experiments will be necessary to evaluate the locus of the actual system and eventually the effectiveness of this system. On Fig.5 the actual mapping A is denoted ($A = T \circ f$) to emphasize the fact that it cannot be obtained directly but only as a composition of f and T. Since f is assumed to be known, the focus of the remaining part of this section is the determination of T.

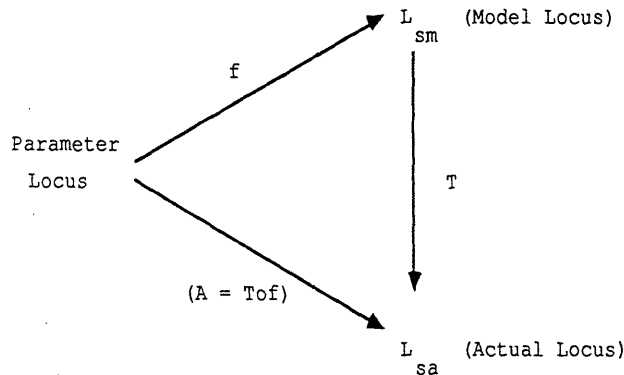

Fig.5: Determination of the actual mapping

A. Inversion algorithm

This sub-section provides a brief description of an inversion algorithm. The purpose of this algorithm is as follows: for a given value in the MOP space, find a value in the parameter space that yields through "f" the desired value in the MOP space. The algorithm must determine whether "f" can be inverted at a specific MOP value, and if it can, the algorithm will yield a parameter vector (which may not be unique) corresponding to the desired MOP value.

A system with m MOPs $\{x_i; i=1, \dots, m\}$ and n parameters $\{p_j; j=1, \dots, n\}$ is considered; generally, n and m are not equal. If "f" is the mapping from the parameter space into the MOP space, then $\underline{x} = f(\underline{p})$, where \underline{x} and \underline{p} are column vectors. If \underline{p}_0 is an initial combination of parameters, the corresponding point in the MOP space is $\underline{x}_0 = f(\underline{p}_0)$; \underline{p}_0 will be called a "basic operating point". One is interested in reaching a desired MOP value \underline{x}_d , with $\underline{x}_d = \underline{x}_0 + \underline{\delta x}$: one has to find $\underline{\delta p}$ such that $f(\underline{p}_0 + \underline{\delta p}) = \underline{x}_d$.

The first step is to determine a small variation $\underline{\delta p}$ around \underline{p}_0 corresponding to a small desired variation $\underline{\delta x}$ around \underline{x}_0 . Since f is generally non-invertible, one has to find an algorithm that determines $\underline{\delta p}$. In order to carry out this first step, f is assumed to be differentiable at $\underline{p} = \underline{p}_0$, and a singular value decomposition of a linear approximation of "f" around \underline{x}_0 is used [Martin 1986]. The algorithm provides a means to determine whether a small variation $\underline{\delta p}$ can be found, and if it

can, a means for choosing among many possible $\underline{\delta p}$. Moreover, the algorithm is designed in such a manner that it guarantees $\underline{p}_0 + \underline{\delta p}$ to be included in the set of allowable parameter values of the system (parameter locus): therefore a real experiment can be conducted at this parameter value [Martin 1986].

Since the single stage algorithm generally yields an approximation of the MOP value one wants to reach, a second step in the procedure is to iterate the single stage algorithm until the difference between the desired value and the computed value is small enough for the application at hand. Therefore, this inversion algorithm provides a means to find a parameter value such that the simplified mathematical model "f" when applied to this parameter value will yield a point in the MOP space arbitrarily close to a desired MOP value.

B. Experimental design

After applying the inversion algorithm, a vector p has been obtained such that: $\underline{x}_d = f(\underline{p})$; the error in the determination of p is assumed to be so small as to be negligible. To determine what the actual system locus looks like, we will choose a small number of desired points in the MOP space (\underline{x}_d). For each of these points, with the inversion algorithm, we will find a parameter vector such that $\underline{x}_d = f(\underline{p})$. Then, an experiment will be run on the actual system at this parameter vector: the outcome of the experiment will be a point \underline{x}_e in the MOP space. Since the simplified model and the actual system are close but not equal, the values \underline{x}_e and \underline{x}_d are going to be different (Fig.6).

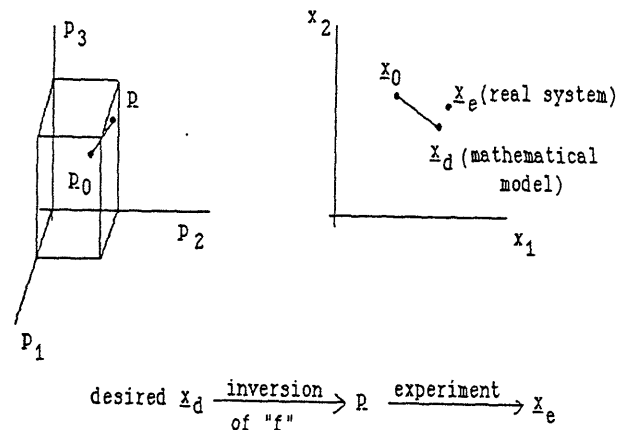

Fig.6 Mathematical and Experimental MOP values

With this procedure, for each desired point selected in the model locus, there will be a corresponding point in the actual locus; to a given set of points in the model locus will correspond a set of points in the actual locus. The only available information for selecting the points \underline{x}_d is the system locus obtained from the mathematical model. With the mapping f, one can easily determine this locus. Since one is interested in having a selection of points that represents the entire locus as opposed to some part or region, the points that will be chosen must be distributed all over the locus. A simple way to choose a small number of points that are representative of the locus is to inscribe it in an n-dimensional rectangular parallelepiped, and to choose the tangency points; the two dimensional case is shown in Fig.7. The procedure is given in detail in [Martin 1986].

This method for choosing the points (x_{di}) in the model locus is not only simple; it is the one that allows one to select the minimum number of points for looking at the whole locus ($2n$ points will be selected where n is the dimension of the MOP space) [Martin 1986].

C. Reconstitution of the actual system locus

We now have all the tools required to select a small number of points in the actual locus, and to compute the mapping T that transforms the model locus into the actual locus. First, let us determine the small number of points we are looking for in the actual locus: We apply the inversion algorithm to the $r = 2n$ points (x_{di}) $i=1, \dots, r$ selected; it yields r vectors (p_i) $i=1, \dots, r$ in the parameter space. Then, experiments corresponding to these parameter vectors are run on the actual system: that is, the experimental conditions are set as required by the parameter vectors. This is always feasible because the parameter vectors determined with the inversion algorithm are constrained to belong to the set of admissible parameters [Martin 1986]. As shown above, the procedure for choosing the points x_{di} is the one that allows one to look at the whole locus with the minimum number of points: thus, given the constraint that one must look at the whole locus, the minimum number of experiments are actually run. The outcome of these experiments will be r experimental values (x_{ei}) $i=1, \dots, r$ in the MOP space (Fig.7).

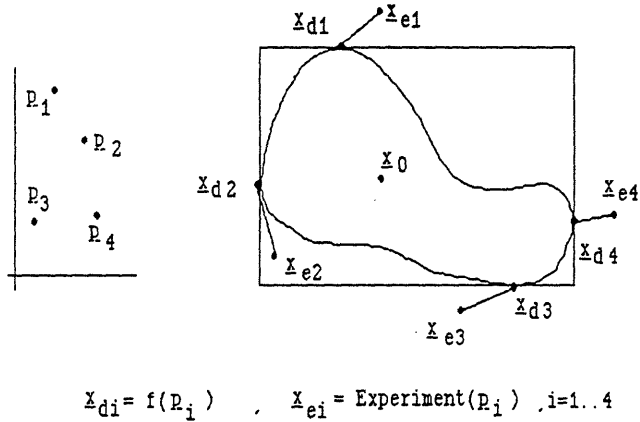

Fig.7 Experimental results

We assume that the transformation T is the composition of a translation \underline{V} and a linear transformation L :

$$T\underline{x} = L\underline{x} + \underline{V}. \quad (4)$$

Let

$$e_i = \|L\underline{x}_{di} + \underline{V} - \underline{x}_{ei}\| \quad (5)$$

where $\| \cdot \|$ represents the euclidian norm. Then the transformation we are searching is the one that minimizes the following expression (r is the number of experiments).

$$J = e_1 + e_2 + \dots + e_r \quad (6)$$

With this transformation T , for each point x_m in the model locus, the corresponding point in the actual locus is

$$x_a = T(x_m). \quad (7)$$

We can interpret A as the transformation T of that maps the parameter locus into the actual system locus. This mapping is the outcome of a mathematical model combined with the small number of experimental values that one can usually afford to run on the actual system. It should be noted at that point that, if the actual system could be exercised for all the values of the parameter locus, it would probably yield an actual system locus slightly different from the one obtained at the end of this section; given the experimental constraints, the actual locus obtained with $A=T$ is the best approximation of the actual system locus that would be obtained by running as many experiments as one would like. Then, with the actual system locus, one can evaluate the effectiveness of the actual system, as opposed to evaluating the effectiveness of a simplified model of the system.

The steps of the experiment design procedure and their interrelationships are shown in Fig.8.

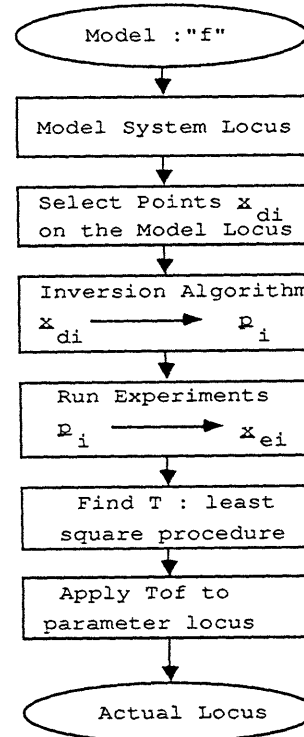

Fig.8 Steps of the experiment design procedure

IV. AN AIR DEFENSE SYSTEM

In this section, a large scale system is presented; it will be used as an example to illustrate the SEA methodology and the experiment design process. This illustration will be provided by a military air defense system known as "Identification Friend Foe Neutral" (IFFN) designed for the central region of Europe. The overall mission of the system is to defend a specified airspace from an air attack carried out by enemy aircraft and missiles.

This system is shown in Fig.9; it is composed of C^2 nodes that coordinate the action of weapons; these nodes can be classified into three major groups: Fire Directing Centers (FDC), Control Reporting Centers (CRC), and a third group composed of more specific nodes such as databases and higher level

nodes. Their role is to coordinate the weapons shown in Fig.9; these weapons can be divided into two categories: Surface to Air Missiles (SAM) such as Hawks and Patriots units, and fighter planes such as F-15 and F-16 aircraft. The mission of the system is to engage and destroy hostile airborne targets or otherwise deny the enemy access to the defended airspace: in particular, the enemy aircraft must be stopped before they can fire missiles at friendly assets. The system must be selective enough to minimize killing friends (F-15 and F-16) or neutrals such as commercial aircraft that are assumed to be flying in the Central Region at the time of the battle.

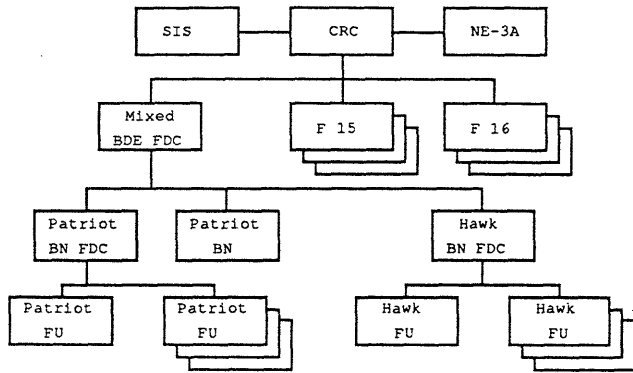

Fig.9 Structure of the actual IFFN system

Abbreviations:

- NE-3A: NATO airborne early warning system; this is a high altitude detection aircraft.
- SIS: Special Information System; this is a source of intelligence information available to basic nodes of the system (CRC or Control and Reporting Center nodes).
- CRC: Control and Reporting Center; this C² node is responsible for the overall coordination of the system.
- FDC: Fire Directing Center; these C² nodes are responsible for the coordination of a battalion.
- FU: Firing Unit BN: Battalion BDE: Brigade

In this complex system, the missiles fired either by a fighter or by a SAM unit are Beyond Visual Range (BVR) weapons: a firing unit does not see the targets it is shooting at; the fire parameters are given to this firing unit by the C² system on the basis of identification performed by other units called "detecting units". This indirect identification process justifies the C² structure that lies above the weapons in Fig.9; it is the responsibility of this C³ system to pass correct and accurate parameters to firing units.

In the next sub-sections, a simplified model of this complex system is introduced.

B. Simplified model: an overview

In the simplified model, the enemy forces are assumed to consist of aircraft only; these enemy aircraft seek to enter the friend's territory; they can fire Air to Surface Missiles (ASM) and Air to Air Missiles (AAM) in order to destroy both ground units and airborne units. For their defense, the friends have aircraft that can fire AAM, and ground units that can fire Surface to Air Missiles (SAM). An enemy unit will refer to aircraft; a friendly asset will refer to both aircraft and ground firing units; for the neutrals, a unit will refer to an aircraft (commercial aircraft).

In this model, the geometry has been simplified: it consists of a straight line (FSCL or Fire Support Coordination Line) separating the friendly forces from the enemy: the system under consideration lies behind the FSCL, and hostile aircraft are heading towards this line at speed V. This model is represented in Fig.10:

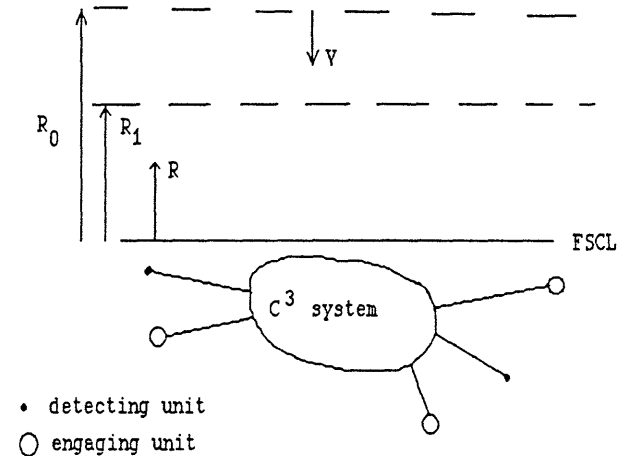

Fig.10 Simplified IFFN model

- R₀ : measurement volume of the system
- R₁ : range of the enemy's air surface missiles
- R : distance separating the enemy's aircraft from the FSCL
- V : speed of enemy's aircraft

An aircraft will be detected by a given detecting unit and engaged by another unit (engaging unit): the task of the C³ system is to identify correctly an aircraft and to allocate it to a given engaging unit. In order to protect friendly assets, the enemy's aircraft must be stopped before they reach R₁, and can fire missiles. It is assumed that the friendly aircraft as well as the neutral aircraft are flying at any speed and in any direction in the diagram sketched above. In what follows, this simplified model is developed, based on the work carried out by Logicon [Logicon 1986]; throughout the section, the notation defined in the IFFN documents [IFFN Test Plan 1985, Logicon 1986] will be used.

C. Parameter definition

To carry out the effectiveness analysis of this system, one must first identify the parameters (the independent variables). The relevant parameters are those defined in the IFFN documentation [IFFN Test Plan 1985, Logicon 1986]. They are independent variables included in [0,1]. For this analysis, the parameters will be:

- time needed to pass information between two nodes (P₁): it depends on whether the SIS (Special Information System) is included or not into the CRC (Control and Reporting Center); this fact is modeled by a varying the time delay required to pass information between two nodes.
- range from aircraft to FSCL at time of detection (P₂): it corresponds to the variable ACP (Air Control Procedure); the effect of varying the ACP is assumed to be the variation of the range from aircraft to FSCL at time of detection: the better the ACP, the larger this range.

- quality of identification (P_3).
- level of centralization of control (P_4)
- quality of target allocation and engagement (P_5):

it corresponds to the quality of the Q&A IFF devices (Question and Answer devices for Identification Friend Foe): since Q&A IFF devices provide local ID information at the weapon level, the quality of these components has a direct effect on allocation and engagement performances.

These parameters reflect the experiments that will be conducted on the IFFN system. Only the five parameters defined above will be varied when applying the SEA methodology: other parameters describing either the system or the context will be fixed in this analysis.

D. Measures of performance

After having defined the parameters, one must specify the MOPs of interest for the system at hand. These MOPs must allow one to make a decision concerning the system: they must have a clear physical interpretation. Let us denote:

- $x(t)$: number of friends at time t
- x_0 : initial number of friends
- $y(t)$: number of enemies at time t
- y_0 : initial number of enemies
- $z(t)$: number of neutrals at time t
- z_0 : initial number of neutrals
- $n(t)$: fraction of friendly forces lost at time t
- $m(t)$: fraction of enemy forces at time t

$$n(t) = (x_0 - x(t)) / x_0, \quad m(t) = (y_0 - y(t)) / y_0 \quad (8)$$

Quantities x_0, y_0, z_0 are measured at the initial time: that is the time when hostile aircraft enter the detection volume (R_0) of the system. Quantities $x(T_f), y(T_f), z(T_f)$ are measured at the final time T_f . The battle stops when either the friendly forces or the enemy's have lost a given fraction of their assets. The final time T_f is defined by

$$\begin{aligned} & (n(t) < n_f \text{ and } m(t) < m_f \text{ for all } 0 \leq t \leq T_f), \\ & \text{and} \quad (n(T_f) = n_f \text{ or } m(T_f) = m_f) \end{aligned} \quad (9)$$

where n_f and m_f represent the strategy of each side: since the friendly forces are defending their own territory, they are probably willing to lose a greater fraction of their forces than the enemy: $n_f > m_f$ is very likely to be true.

In order to enable one to evaluate the system, the MOPs we will consider must have a clear physical meaning: as pointed out above, we want the system to perform a threefold task: deter enemy from entering the friend's territory, stop the enemy as far as possible from this territory and before he can fire missiles aimed at friendly assets, and kill as few neutral as possible.

To evaluate the first task, we need a quantity indicating whether the friends win the battle or not; an indicator of the willingness of the friends to keep on fighting is the ratio

$$x(T_f) / (x_0 * (1 - n_f)) = (1 - n(T_f)) / (1 - n_f). \quad (10)$$

This ratio measures how far the remaining forces of the friends are from their lowest acceptable level as given by $1 - n_f$. If the friends win the battle, this ratio will be greater than one; if they loose, it will be equal to one since they are giving up when their level of losses reaches n_f . A similar ratio can be defined for the enemy. Then, we will consider as the first MOP of our problem, the ratio of these two ratios: this ratio of ratios will compare the willingness of the two opponents to keep on fighting. Thus we define

$$MOP1 = [x(T_f) / (x_0 * (1 - n_f))] / [y(T_f) / (y_0 * (1 - m_f))] \quad (11)$$

If $MOP1 > 1$, the hostile aircraft fly back because their losses have reached m_f while $n(T_f) < n_f$. If $MOP1 < 1$, the friendly forces give up and loose the battle because their losses have reached n_f while $m(T_f) < m_f$ [Martin 1986].

The second quantity we want to evaluate is the number of neutral aircraft killed by the friendly forces; indeed, since we are interested in evaluating the friend's system as opposed to the enemy's one, we consider only the neutrals shot down by the friends' air-defense. Thus, we are interested in the number of neutrals remaining at the end of the battle; the MOP that will measure this performance of the system is:

$$MOP2 = z(T_f) / z_0 \quad (12)$$

The last quantity of interest is the distance of the enemy from the FSCL when the battle ends. This is measured by the following ratio:

$$MOP3 = R_f / R_1 \quad (13)$$

where R_f is the distance of the remaining enemy's aircraft at the final time T_f .

If $MOP3 > 1$, the enemy aircraft are stopped before they can fire missiles aimed at friendly assets. If $MOP3 < 1$, the enemy aircraft can fire missiles before being stopped. The greater this ratio is, the better it is for the friendly forces.

E. Mapping from the parameter space into the MOP space

We can map now the parameter space into the MOP space; the basis of this development is the work completed by Logicon [Logicon 1986], where about thirty quantities representing the way the IFFN system performs are defined. Most of these quantities are conditional probabilities that describe the different stages of the air defense process. These quantities are called MOPs and MOEs in the Logicon documentation; since they are different from the MOPs and MOEs we consider for the SEA methodology, and since we want to keep the notation defined by Logicon, these quantities will be denoted "Mop" and "Moe" as opposed to "MOP" and "MOE" in the SEA methodology. First of all, we are going to make assumptions about the value of these Mop's and Moe's in terms of the parameters (the independent variables); then we will aggregate the conditional probabilities (Mops and Moes) defined in the IFFN documents [Logicon 1986] in order to determine four basic quantities: probability of engaging a friend, a neutral, or a hostile, and the time elapsed between detection and engagement; finally, we will use a Lanchester model [Ekchian 1982, Taylor 1974, Moose and Wozencraft 1983] to derive the MOPs (for our problem) in terms of the parameters. The process outlined above is presented in Fig.11.

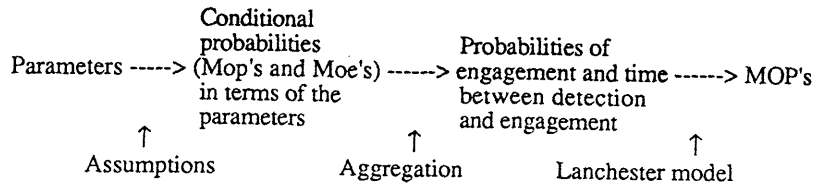

Fig. 11: Steps in the determination of the model

Let us now introduce briefly a simplified version of the Logicon model. The basic stages of the air defence process are: detection, identification (ID), comparison between different IDs coming from different detecting units, conflict resolution, allocation, and engagement. A conditional probability is associated to each of these stages. To these six stages corresponding to physical processes, one must add a fictitious step that describes the probability of true identification. The stages of this process are described in greater detail in [Martin 1986].

Each of the conditional probabilities (Moe or Mop) that characterizes the basic stages of the process is then expressed in terms of the parameters: because of the lack of accurate information, only rough estimates are considered.

For example, the probabilities Mop3.5 (probability of conflict between the ID of two different sensors) and Mop3.6 (probability of conflict resolution) are assumed to be functions of the level of centralization only. The probability of conflict (Mop3.5) must decrease, and the probability of conflict resolution (Mop3.6) must increase when the process becomes more centralized ($P_4=1$ when centralization is total).

$$\text{Mop3.5} = 0.75 - 0.5 * P_4 \quad (14)$$

$$\text{Mop3.6} = 0.25 + 0.5 * P_4 \quad 0 \leq P_4 \leq 1 \quad (15)$$

The value of the other conditional probabilities in terms of the parameters are given in [Martin 1986]. Given the decision trees that model the IFFN process, it is then possible to aggregate the conditional probabilities defined above into three basic quantities: probability to engage a friend (Moe 7), a neutral (Moe 8) or an hostile (Moe 9). Each of these trees is conditioned on the true ID of the aircraft; for example, the tree represented in Fig.12 assumes that the true ID of the aircraft under consideration is "friend". This tree yields:

$$\text{Moe7} = \text{Moe1} * \text{Moe3} * P(\text{ih}/\text{fd}) * P(\text{a}/\text{fi}) * P(\text{e}/\text{fa}) * A \quad (16)$$

with

$$A = (1 - P(\text{ih}/\text{fd})) * (1 - \text{Mop3.5}) * \text{Mop3.6} + \text{Mop3.5} + P(\text{ih}/\text{fd}) * (1 - \text{MOP3.5}) * \text{Mop3.6}$$

and $P(\text{ih}/\text{hd})$ is the probability of identifying an aircraft as hostile, given it is a friend and given it has been detected.

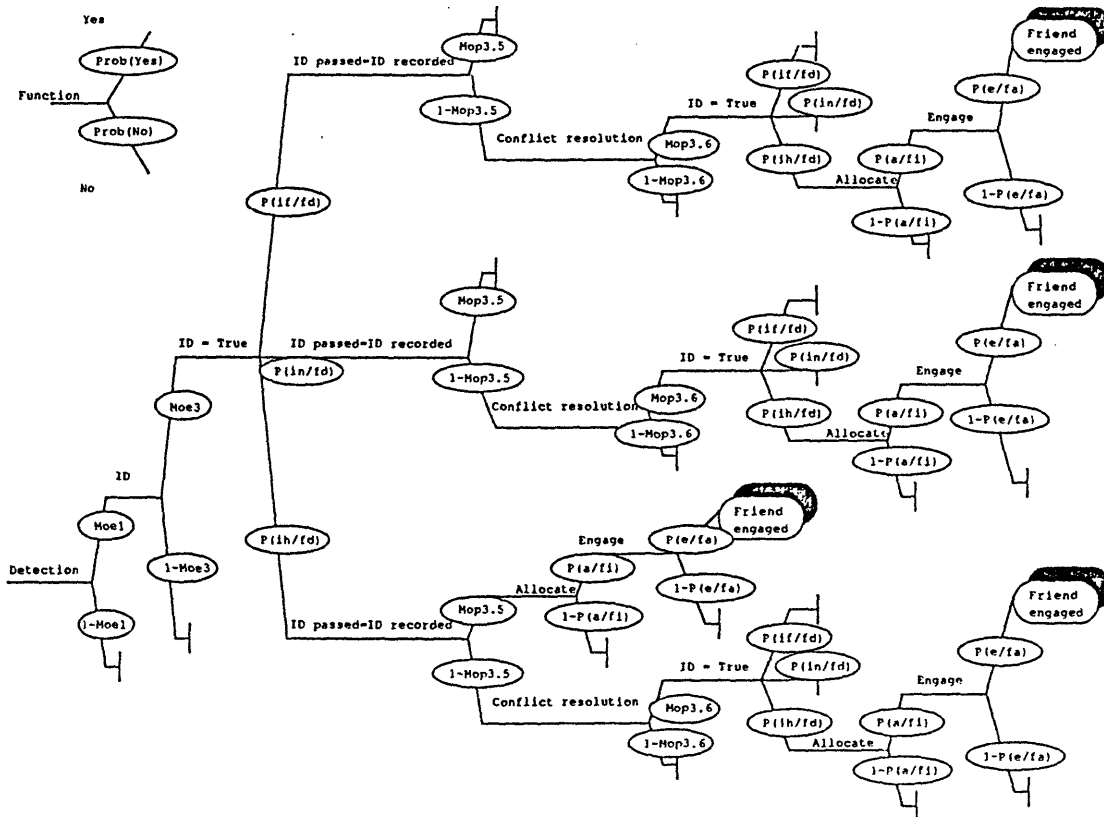

Fig. 12 Decision Tree for Friends

Moe8 and Moe9 are computed in a similar manner. Since there is a time delay associated with each stage of the process, it is also possible with these decision trees to determine the "mean time elapsed between detection and engagement" (Moe10).

The final step to determine the three MOPs is the use of the Lanchester equations [Ekchian 1982, Taylor 1974, Moose and Wozencraft 1983]: from an initial number of aircraft of each type, we determine the final number in each category ($x(T_f)$, $y(T_f)$, $z(T_f)$) on the basis of the probabilities computed from the decision trees.

In the Lanchester model, it is assumed that all the friends are within the weapon range of the enemy, and that all the neutrals and all the hostiles are within the weapon range of the friend's units. Since we are interested in the performance of the indirect ID process, we consider losses in friendly forces to be due to the enemy action, and to errors within the friend ID process; we consider losses in the enemy forces, and neutral losses to be due to the friend's fire only; indeed, we are interested in the performance of the friend's air defense system only. The equations are:

$$dx/dt = -a*x - b*y \quad x=x_0 \text{ at } t=0 \quad \text{for } 0 \leq t \leq T_f \quad (17)$$

$$dy/dt = -c*x \quad y=y_0 \text{ at } t=0 \quad \text{for } 0 \leq t \leq T_f \quad (18)$$

$$dz/dt = -d*x*z \quad z=z_0 \text{ at } t=0 \quad \text{for } 0 \leq t \leq T_f \quad (19)$$

where "a" is the probability of engaging a friend per unit of time; thus,

$$a = \text{Moe7}/\text{Moe10}$$

Similarly,

$$c = \text{Moe9}/\text{Moe10} \quad \text{and} \quad d = \text{Moe8}/\text{Moe10}$$

b, the probability for an enemy to kill a friend, is assumed to be exogenous and fixed independently of the parameters.

Equations 17, 18 and 19 can be easily integrated [Martin 1986], and the final time T_f is given by :

$$n(T_f) = n_f \quad \text{or} \quad m(T_f) = m_f \quad (20)$$

We can now compute the three MOPs (MOP1, MOP2, MOP3) of the system for each point (P_1, P_2, P_3, P_4, P_5) in the parameter space:

$$\text{MOP1} = [x(T_f)/(x_0*(1-n_f))]/[y(T_f)/(y_0*(1-m_f))] \quad (21)$$

$$\text{MOP2} = z(T_f)/z_0 \quad (22)$$

$$\text{MOP3} = (\text{Mop1.2} - V*T_f)/R_1 \quad (23)$$

(Mop1.2 is the range from aircraft to FSCL at time of detection).

V. APPLICATION OF SEA AND EXPERIMENT DESIGN

The results of the System Effectiveness Analysis methodology applied to the mathematical model developed in section IV are presented in this section.

A. Mission Locus

In order to evaluate the system at hand vis a vis the mission it has to perform, the mission requirements must be expressed in terms of the MOPs defined for the system.

Qualitatively, the mission the system has to fulfill is to deter enemy aircraft from invading friendly territory, without killing neutrals, and to prevent enemy aircraft from firing missiles aimed at friendly assets. In term of the MOPs, it means that MOP1 must be greater than 1, that MOP2 must be as close as possible to 1, and that MOP3 must be greater than 1.

By definition, MOP2 is less than 1, MOP3 is less than R_0/R_1 , and it can be shown that MOP1 is less than $1/(1-n_f)$ [Martin 1986]. The quantitative requirements are assumed to be as follows:

$$1/(1-n_f) \geq \text{MOP1} > \text{MOP1}_0 = 1.1 \quad (24)$$

$$1 \geq \text{MOP2} \geq \text{MOP2}_0 = 0.8 \quad (25)$$

$$1 \geq \text{MOP3} \geq \text{MOP3}_0 = 1.0 \quad (26)$$

Relation (24) requires the friends to win the battle with a 10% margin; inequality (25) requires that no more than 20% of neutrals be killed, and relation (26) requires the enemy forces to be stopped before they have crossed the line from which friendly positions are within range. These requirements define in the MOP space the mission locus shown in Fig.13. One should note that this mission locus is bounded.

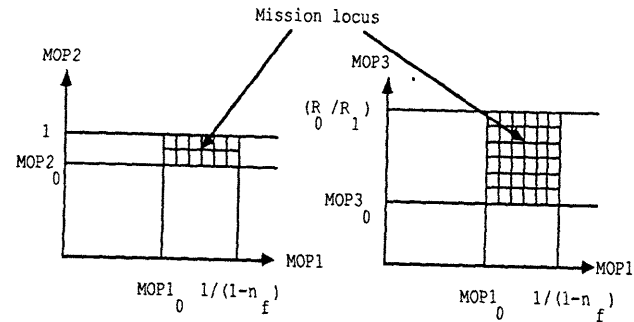

Fig.13 Projections of the Mission locus

For $n_f=0.6$, and the requirements set up above, if L_m denotes the mission locus and $V(L_m)$ its volume, one can compute

$$V(L_m) = 0.28 \quad (27)$$

B. System Locus

To represent the system locus, we will consider a family of partial loci: for each of these partial loci, parameters P_1 and P_2 will be held constant, and parameters P_3, P_4, P_5 will be varied. If P_1 is held constant, it means that the time delay to pass information from one node of the system to another is kept constant. Similarly, if P_2 is held constant, it means that the Air Control Procedure is not changed. Then, the entire locus is considered as a union of partial loci - it allows for a more complete interpretation of the plots.

We assume the range of parameter variation shown in Table 1:

Table 1: Parameter ranges

	Definition	Minimum	Maximum
P ₁	Time delay to pass information	0.10	0.95
P ₂	Air Control Procedure	0.75	0.95
P ₃	Quality of identification	0.75	0.99
P ₄	Level of centralization	0.50	0.99
P ₅	Quality of Q&A IFF devices	0.75	0.99

These ranges have been chosen to yield realistic values for the aggregate quantities defined by Logicon [Logicon 1986](the "Mops" and "Moes" considered in section IV).

We will consider four partial loci, corresponding to the maximal and minimal values of P₁ and P₂ :

- P₁ = P_{1max} and P₂ = P_{2max} -----> Partial Locus #1
- P₁ = P_{1min} and P₂ = P_{2max} -----> Partial Locus #2
- P₁ = P_{1min} and P₂ = P_{2min} -----> Partial Locus #3
- P₁ = P_{1max} and P₂ = P_{2min} -----> Partial Locus #4

Before showing pictures of the whole locus, let us set P₁=constant, P₂=constant, P₃=constant and consider the set of MOP points obtained by varying P₄ and P₅: this will yield a "slice" of the partial loci we will obtain later, and give us insight into the locus construction; a typical "slice" is shown in Fig.14 and Fig.15. Fig.14 corresponds to the projection of this slice on the plane (MOP1/MOP2), and Fig.15 to the projection on the plane (MOP1/MOP3).

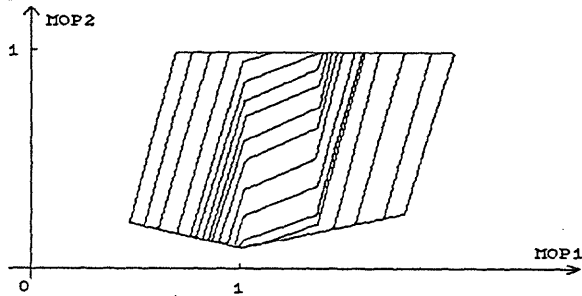

Fig.14 A slice of the system locus in the plane MOP1/MOP2

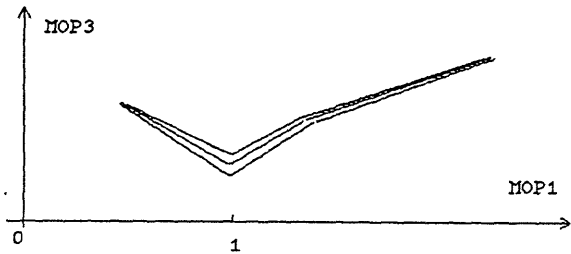

Fig.15 A slice of the system locus in the plane MOP1/MOP3

The purpose of these two figures is to show the shape of a typical slice of the system locus; actual and accurate plots will be shown later. One can note an irregularity that corresponds to MOP1=1, that is to the change in the terminating condition (time T_f): if MOP1 is less than 1 the friends give up; if MOP1 is greater than 1, the enemies give up.

In Fig.15, MOP3 increases if MOP1 is greater than 1 and if MOP1 increases: indeed, the wider the margin by which the friendly forces are winning, the farther from the FSCL line the enemy is repulsed; on the other hand, if MOP1 is less than 1, MOP3 increases as MOP1 decreases: indeed, if the friends are loosing, the wider the margin by which they are loosing, the smaller the terminating time T_f is; the smaller the terminating time, the smaller the distance traveled by the enemy during the battle is. In this latter case, since the enemy aircraft are not repulsed, they will eventually invade the friend's territory.

In Fig.14, a vertical (or kinked) line is drawn for each value of P₄, that is for each level of centralization as represented by P₄ (P₄=1 for total centralization); the greater the value of P₄, the farther on the left of the diagram the corresponding vertical line is, and the smaller MOP1 is. It means that the lower the level of centralization, the greater MOP1 is, that is, the greater the chances of winning the battle are; this is the result of a trade-off between the accuracy in the ID process and the time needed to perform the identification: the more accurate the ID is, the longer it takes. It turns out that in the model, the time increase in the ID process due to a higher level of centralization is the most important of the two effects (the second effect being an increased accuracy). For a given vertical line (that is for P₄=constant), the greater P₅, that is the better the Question and Answer IFF devices are, the greater MOP2 is: it means that the better the Question and Answer devices, the greater MOP2 is, and the smaller the number of neutral killed is. These Q&A devices affect slightly MOP1 except around MOP1=1 where the quality of these devices is very important: around MOP1=1, the battle can be won or lost depending on the quality of the Q&A IFF devices.

For the next plots, P₃ will be varied with P₄ and P₅: we will obtain as many slices as the one of Figs.14 and 15 as values of P₃ considered. One should recall that P₃ represents the quality of identification (P₃=1 for perfect ID capabilities).

Projection on the plane MOP1/MOP2

In Fig.16, Fig.17, and Fig.18 projections on the plane (MOP1/MOP2) are represented; in Fig.16 the projection of partial loci #1 and #4 (their projections on the plane MOP1/MOP2 are the same) is shown, while in Fig.17 the projection of partial loci #2 and #3 (their projections on the plane MOP1/MOP2 are the same) is shown. For these two latter plots, if all parameters but P₃ are fixed, an increase in P₃ yields a higher MOP1 and a higher MOP2: the better the ID capabilities of the system the easier it is for the friends to win, and the smaller the number of neutrals killed by the system is.

Partial loci #1 and #4 correspond to P₁=P_{1max}; that is the longest time delay to pass information between two nodes of the system; on the other hand, partial loci #2 and #3 correspond to the shortest time delay to pass information between two nodes. From these two loci one can check the consistency of the model: the shorter the time to exchange information between nodes, the greater MOP1, and the greater the chances of winning the battle.

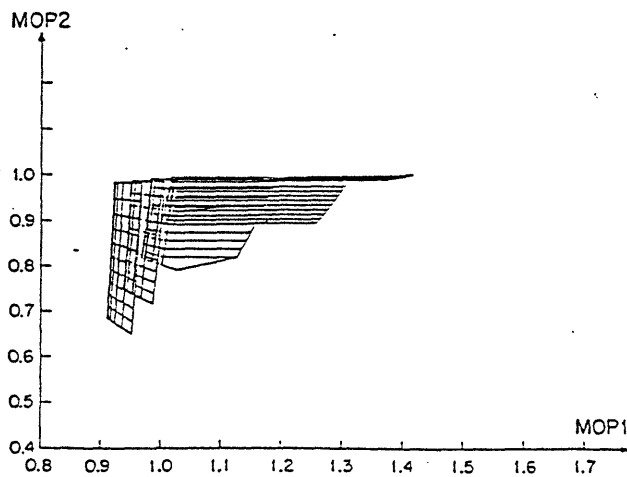

Fig. 16 Partial Loci #1 and #4 projected on plane MOP1/MOP2

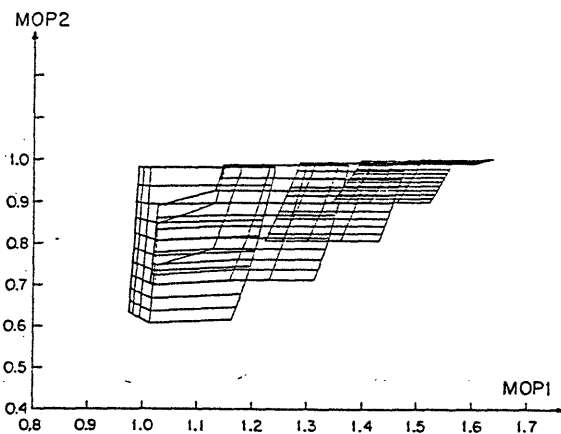

Fig. 17 Partial Loci #2 and #3 projected on plane MOP1/MOP2

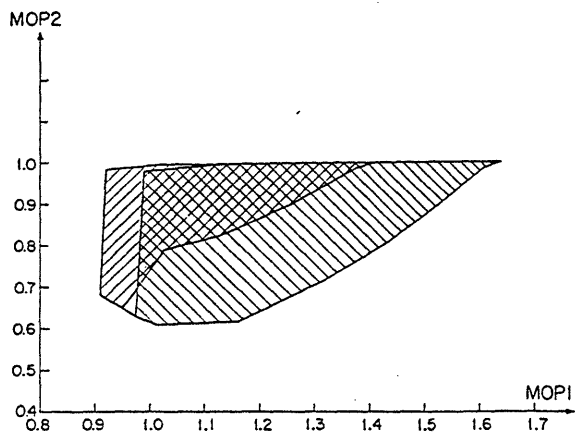

Fig. 18 Entire System Locus projected on plane MOP1/MOP2

In Fig. 18 the projection of the entire system locus on the plane MOP1/MOP2 is shown ; it is obtained by superposing the two previous plots.

Projection on the plane MOP1/MOP3

In Fig. 19, the projection of the entire locus on the plane MOP1/MOP3 is shown . The upper part corresponds to partial loci #1 and #2, or to the highest quality of Air Control Procedure ($P_2 = P_{2max}$); the lower part of Fig. 19 corresponds to partial loci #3 and #4 and to a low quality Air Control Procedure (ACP). The better the ACP , the greater MOP3: indeed, with a good ACP one can detect an enemy aircraft early and therefore stop it far away from the FSCL. The angle at MOP1=1 corresponds to the change in the terminating conditions; it corresponds to the irregularity already noted on previous plots around MOP1 = 1.

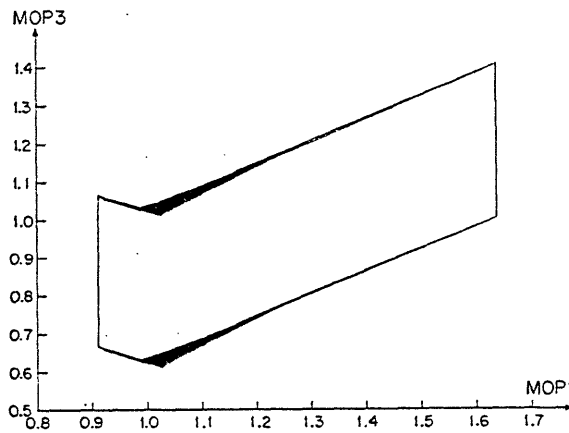

Fig. 19 Entire System Locus projected on plane MOP1/MOP3

Projection on the plane MOP3/MOP2

The projection of the entire system locus on plane MOP3/MOP2 is shown in Fig. 20. The left side of the figure corresponds to partial loci #3 and #4 (low quality ACP), while the right side of the figure corresponds to partial loci #1 and #2 (high quality ACP).

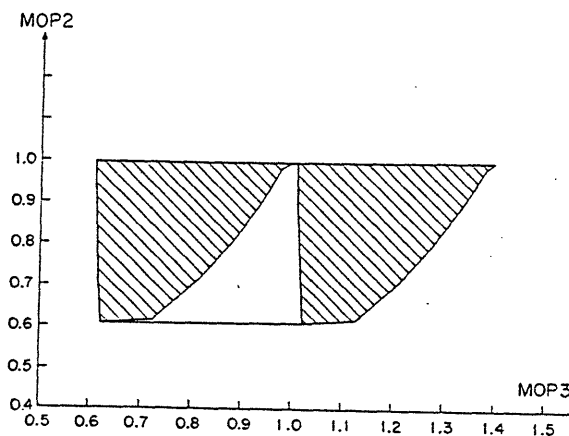

Fig. 20 Entire System Locus projected on plane MOP3/MOP2

C. Measures of Effectiveness for the Model

If L_s designates the system locus and L_m designates the mission locus, and if $V(L)$ is the volume of L , then, to compute the effectiveness of the mathematical model of the system, one must evaluate $V(L_s \cap L_m)$, and $V(L_m)$ or $V(L_s)$ depending on the MOE one is interested in. E_1 measures how well the system capabilities are used, and E_2 measures how well the mission is covered by the system.

For the basic operating point considered in this section, we have

$$V(L_s \cap L_m) \approx 0.020 \quad \text{and} \quad V(L_s) = 0.068 \quad (28)$$

Therefore

$$E_1 = 0.292, \quad \text{and} \quad E_2 = 0.071 \quad (29)$$

E_2 is very small because of the size of the mission locus which takes into account such unrealistic events as the possibility for the friends of winning the battle without loosing any asset. Therefore, the degree of coverage of the mission locus by the system locus (E_2) is very low.

D. Experiment Design

The presentation of the results follows the same format as in section III.

Step 1: Determination of the model locus.
This step has been completed above.

Step 2: Selection of points on the model locus.

As mentioned earlier, we inscribe the model locus in a parallelepiped, and choose the points of contact between the model locus and the parallelepiped (or the center of gravity of these points). In what follows a row vector \underline{x} is as follow:

$$\underline{x} = [\text{MOP1}, \text{MOP2}, \text{MOP3}] \quad (30)$$

For the model system locus obtained above and shown in Figs.16 to 20, six points of contact are obtained:

$$\begin{aligned} \underline{x}_{d1} &= [1.639, 0.999, 1.203] & \underline{x}_{d4} &= [0.911, 0.687, 0.867] \\ \underline{x}_{d2} &= [1.432, 0.999, 1.081] & \underline{x}_{d5} &= [1.00, 0.611, 0.826] \\ \underline{x}_{d3} &= [1.639, 0.999, 1.403] & \underline{x}_{d6} &= [1.028, 0.987, 0.610] \end{aligned}$$

The six vectors obtained above represent the entire system locus as opposed to any of its region. The three first vectors correspond to maximum values for the MOPs in the system locus. The three last vectors correspond to minimum values for the MOPs in the system locus.

Step 3: Inversion algorithm.

For each of the points \underline{x}_{di} determined above, we compute a parameter value p_i such that $\underline{x}_{di} = f(p_i)$, where f denotes the mathematical model of the system. If one notes a parameter vector \underline{p} as a row vector

$$\underline{p} = [P_1, P_2, P_3, P_4, P_5] \quad (31)$$

then, the parameter vectors corresponding to the \underline{x}_{di} determined above are

$$\begin{aligned} p_1 &= [0.205, 0.850, 0.990, 0.500, 0.904] \\ p_2 &= [0.554, 0.850, 0.990, 0.694, 0.911] \\ p_3 &= [0.204, 0.950, 0.990, 0.500, 0.900] \\ p_4 &= [0.685, 0.850, 0.750, 0.846, 0.933] \\ p_5 &= [0.521, 0.851, 0.821, 0.652, 0.750] \\ p_6 &= [0.873, 0.750, 0.874, 0.990, 0.990] \end{aligned}$$

These values were obtained using the algorithm described in Section III. As expected, they are within the admissible range of variation in the parameter space as defined by Table 1. Table 2 summarizes the physical significance of the parameter vectors obtained using the inversion algorithm.

Table 2: Physical significance of the parameter vectors

		Time delay to pass Information	Quality of Air Control Procedure	Quality of Identification	Level of Centralization	Quality of Q&A IFF Devices
Maximum MOP1	p_1	Small	Medium	Maximum	Minimum	High
Maximum MOP2	p_2	Medium	Medium	Maximum	Medium	High
Maximum MOP3	p_3	Small	Maximum	Maximum	Minimum	High
Minimum MOP1	p_4	High	Medium	Minimum	High	High
Minimum MOP2	p_5	Medium	Medium	Medium	Medium	Minimum
Minimum MOP3	p_6	High	Minimum	Medium	Maximum	Maximum

MOP1 and the margin by which the battle is won is strongly linked to the quality of identification (ID): the maximum MOP1 is obtained for the maximum quality of ID and the minimum level of centralization, and the minimum MOP1 is obtained for the minimum quality of ID and the highest level of centralization. The fact that an increase in the quality of ID improves MOP1 is easy to predict. The greater the level of centralization, the lower MOP1 is: this is the result of a trade-off outlined earlier between the increase in the accuracy of the ID process due to a higher level of centralization, and the increase in the time needed to perform this ID also due to a higher level of centralization: it turns out that the second of the two effects is the most important one, thus reducing MOP1. One should also note that MOP1 depends on the time delay to pass information between nodes: the smaller this time delay, the faster the response of the system, and the greater MOP1 is.

MOP2 appears to be linked to the quality of ID and to the quality of the Q&A IFFN devices which provide local ID information: the greater the quality of ID and the better the local ID information, the lower the number of neutrals killed by the friendly forces is.

MOP3 depends mostly on the Air Control Procedure (ACP), and on the time delay to pass information between nodes: the better the ACP and the smaller the time delay to pass information, the greater MOP3 is. Indeed with a good ACP, one is able to detect the enemy far in the detection volume, and the smaller the time delay to pass information, the faster the response of the system and the greater MOP3 is.

Step 4: Experimental results.

At this stage, experiments are run at the parameter vectors determined at stage 3. Since we cannot run experiment on the actual system for the purpose of this paper, a mathematical model which is slightly different from the one introduced earlier has been used. The pseudo-experimental values obtained by exercising the modified model are

$$\begin{aligned} \underline{x}_{e1} &= [1.513, 0.999, 1.128] & \underline{x}_{e4} &= [0.911, 0.688, 0.868] \\ \underline{x}_{e2} &= [1.436, 0.999, 1.082] & \underline{x}_{e5} &= [0.997, 0.617, 0.830] \\ \underline{x}_{e3} &= [1.509, 0.999, 1.372] & \underline{x}_{e6} &= [1.006, 0.903, 0.565] \end{aligned}$$

Step 5: Transformation from the model locus into the actual locus.

If \underline{x}_m is a point in the model locus and if \underline{x}_a is the corresponding point in the actual locus, the least square procedure presented in section III yields the following transformation

$$\underline{x}_a = T(\underline{x}_m) = L\underline{x}_m + \underline{V}, \quad (32)$$

where L is a linear transformation (defined by a 3x3 matrix) and \underline{V} a constant translation vector. For the example at hand we have

$$L = \begin{bmatrix} 0.831 & 0.046 & -0.151 \\ 0.042 & 0.813 & 0.0008 \\ -0.007 & 0.078 & 1.127 \end{bmatrix} \quad \underline{V} = \begin{bmatrix} 0.142 \\ 0.017 \\ 0.043 \end{bmatrix} \quad (33)$$

Step 6: Construction of the actual locus.

For each point in the parameter locus we apply $A = T \circ f$ where "o" denotes the composition of two functions and where "f" stands for the mathematical function that maps the parameter locus into the model system locus.

For the example at hand, since the shape of the actual locus is qualitatively the same as the one of the model locus, only comparisons of the two loci will be presented: in the following plots, the contours of the projections of both the model and the actual locus are shown; these projections are done on the planes MOP1/MOP2 (Fig.21), MOP1/MOP3 (Fig.23), MOP2/MOP3 (Fig.24).

E. Effectiveness of the Actual System

From the actual locus of the nominal system constructed above, one can evaluate the effectiveness of the system. If L_{sa} denotes the actual system locus, then, the measures of effectiveness for the actual system are:

$$E_1 = 0.300 \quad (0.292), \quad E_2 = 0.049 \quad (0.071) \quad (34)$$

The value of E_1 obtained for the actual system is slightly greater than the ones obtained for the model. It means that the capabilities of the actual system are better used than one could have thought by studying the model only. On the other hand, the value of E_2 is slightly smaller for the actual system than it is for the model: the degree of coverage of the mission is smaller for the actual system than for the model.

In this section, the methodology developed throughout this paper has been applied to the IFFN system: the procedure to evaluate the effectiveness of an actual system has been demonstrated.

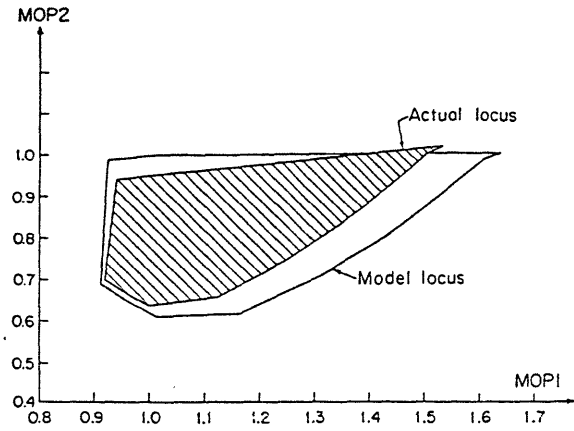

Fig. 21 Actual and Model Loci projected on Plane MOP1/MOP2

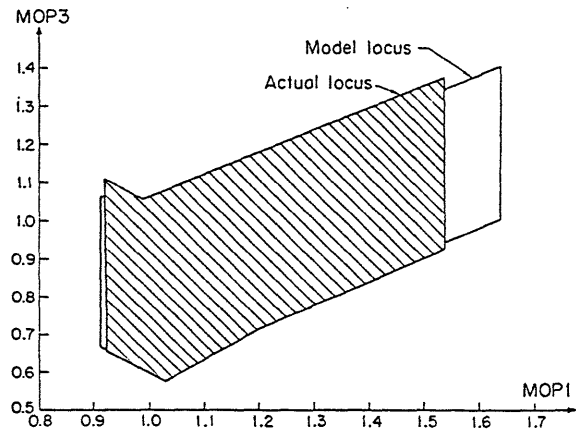

Fig. 22 Actual and Model Loci projected on Plane MOP1/MOP3

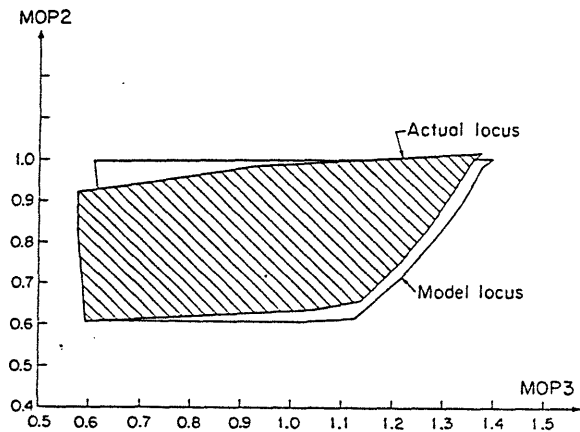

Fig. 23 Actual and Model Loci projected on Plane MOP3/MOP2

VI. CONCLUSION

In this paper, a methodology aimed at evaluating actual C^3 system has been developed; this methodology provides a means to design the minimum number of experiment to run on a large scale C^3 system in order to evaluate it. The experiment design procedure as well as the evaluation procedure have been applied to a real air defense system. The tools presented in this paper provide the system developer with a powerful methodology: it gives him directions so as to which experiments he should run on the system at hand, and it allows him to evaluate this system based on well designed experiments.

In this paper a crude mathematical model of the air defense system has been introduced; further research should develop this modeling aspect in order to yield as accurate models of C^3 systems as possible. With a better model of the organization at hand, the experiment design process as well as the evaluation will be much more accurate than in this paper.

REFERENCES

- Bouthonnier V. and Levis A.H. (1984) , "Effectiveness Analysis of C^3 Systems," IEEE Trans. on Systems, Man, and Cybernetics, Vol. SMC-14, No. 1.
- Cothier P.H. (1984), "Assessment of Timeliness in Command and Control," MS Thesis, LIDS-TH-1391, Laboratory for Information and Decision Systems, MIT, Cambridge, MA.
- Cothier P.H. and Levis A.H. (1986), "Assessment of Timeliness in Command and Control," IEEE Trans. on Systems, Man, and Cybernetics, SMC-16, No. 6.
- Debreu G. (1968), Theory of Value: An Axiomatic Analysis of Economic Equilibrium, Wiley, New York.
- Dersin P. and A.H. Levis (1981), Large Scale Systems Effectiveness Analysis. Report LIDS-FR-1072, Laboratory for Information and Decision Systems, MIT, Cambridge, MA.
- Ekchian L.K. (1982). "An Overview of Lanchester-Type Combat Models for Warfare Scenarios". LIDS-P-1193, Laboratory for Information and Decision Systems, MIT, Cambridge, MA.
- Martin P.J. (1986), "Large Scale C^3 Systems: Experiment Design and System Improvement," MS Thesis, LIDS-TH-1580, Laboratory for Information and Decision Systems, MIT, Cambridge, MA.
- Mishan E.J. (1976), Cost-Benefit Analysis, Praeger Publishers, New York.
- Moose P.H., Wozencraft J.M. (1983), Lanchester Equations and Game Theory. Proceedings of the 6th MIT/ONR Workshop on C^3 systems, MIT, Cambridge, MA.
- Taylor J.G. (1974), Lanchester-Type Models of Warfare and Optimal Control. Naval Research Logistics Quarterly, Vol.21, No.1, pp.79-106.
- White J.A., Agee M.H., Case K.E. (1985), Principles of Engineering Economic Analysis, Wiley, New York.
- Identification Friend, Foe, or Neutral (IFFN). Test Plan (TP), (1985), Air Force Army Joint Test Force, November.
- Logicon (1986), MOE/MOP Mapping to Air Defense Functions, document no 85-0121, Logicon, Inc., Tactical and Training Systems Division, San Diego, CA, February.
- Logicon (1986), MOE/MOP Mapping to Air Defense Functions, document no. 09-0124, Logicon, Inc., Tactical and Training Systems Division, San Diego, CA, April.