

A Strategic Approach to Supply Chain Event Management

by

Esmè Fantozzi
M.S. in Physics
Padova University, Italy, 1996

Submitted to the Engineering System Division
In Partial Fulfillment for the Request of the Degree of

Master of Engineering in Logistics

at the

Massachusetts Institute of Technology

June 2003

© 2003 Esmè Fantozzi, All Rights Reserved

The author hereby grants to M.I.T. permission to reproduce and distribute publicly paper and electronic copies of this thesis document in whole or in part.

Signature of the Author _____
Engineering Systems Division
May 9th, 2003

Certified by _____
James Masters
Executive Director MLOG Program
Thesis Supervisor

Accepted by _____
Yossi Sheffi
Professor of Civil and Environmental Engineering
Professor of Engineering Systems
Co-Director, Center for Transportation and Logistics

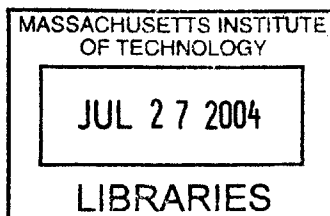

BARKER

Abstract

This thesis project explores the possibility to apply project management techniques, specifically critical path method, and PERT, to supply chain event management.

The idea behind the project is to create a framework for putting supply chain events into a broader supply chain context and assessing their criticality. Such a framework can then be utilized as a starting point for supply chain event management software applications

The problem has been approached from a “micro” point of view, with the analysis and PERT modeling of a single order fulfillment process, and from a “macro” point of view, with the analysis and a very simple model of the inventory itself.

Finally, there are important factors that can drive the development and adoption of such systems in the future, including a higher level of supply chain informatization, removal of inter-and intra-company communication barriers, and better software integration technologies to effectively link all the element of the supply chain network.

Acknowledgments

I must begin by thanking Jim Masters for guiding me through this process of learning and creation. His support and maieutic ability have been tremendously helpful.

Many of my Masters of Logistics classmates have been invaluable to the learning experience, and a special mention goes to Ricardo Dobrusky, Bill Driegert, Craig Prisby and Jeff Silver.

I really want to thank Stefano Curtatolo, for his support, humor, and unlimited trust in my success; Maria Letizia Fabbrini, and Carlo Fantozzi, a constant source of inspiration; and Iglío Curtarolo, who made many long hours of study and research enjoyable, with his playful attitude.

I must also thank Jana Clemons, my number one fan, and the best friend of all.

Table of Contents

Abstract.....	2
Acknowledgments.....	3
Table of Figures	4
Chapter 1 Introduction	6
1.1 The evolution of supply chain event management applications	6
1.2 Future Generations of Event Management Applications.....	7
1.3 Shortcomings of present event management applications	8
Chapter 2 Literature Review	12
2.1 Inventory parameters	12
2.2 Project management, CPM, and PERT networks.	13
2.3 Existing event management software	19
Chapter 3 Development of the Concept.....	22
3.1 Micro-dynamics approach: a network path for the order fulfillment process	22
3.2 Macro-dynamics approach: a network path for inventory management	26
3.3 Memory of past events: turning event management into a tool for monitoring mid- and long-time strategic goals.	29
Chapter 4 Conclusions and Findings	31
4.1 Key Findings.....	31
4.2 What is needed to get there	33
Bibliography	35
List of Acronyms	36

Table of Figures

Figure 1, Project network.....	15
Figure 2, Time-scaled network	15
Figure 3. PERT micro-system, nodes definition.....	23
Figure 4. PERT project network for the order fulfillment.....	23

Figure 5: Micro-system activities table.....	24
Figure 6: estimate of time and variance for each node	24
Figure 7. Probability associated with the completion time estimate	25
Figure 8. PERT macro-system, nodes definition	26
Figure 9. PERT project network for a basic inventory management model.....	26
Figure 10: Macro-system activities.....	27
Figure 11: estimate of time and variance for each node	27
Figure 12. Probability associated with the completion time estimate	28

Chapter 1 Introduction

Supply chain event management systems include a vast number of software solutions aimed at supporting supply chain management by leveraging real-time availability of supply chain data, and algorithms capable to recognize, notify, and sometimes manage exceptions.

Event management software's primary functions include

- measurement,
- monitoring,
- proactive notification,
- decisions support and
- control of supply chain by events.

Several hundred suppliers have already developed and launched in the market software applications that cover a number of supply chain activities. MRP, DRP, and forecasting tools support supply chain and logistics planning activities, while ERP, warehouse management, inventory track and trace systems support management of most of the execution and operational activities. An entire software category, CRM, handles the relationship with the customers in many of its aspects.

Ideally, event management software application should be able to link the entire supply chain, monitoring the flow of goods and information, and alerting any time that a potentially disruptive event or chain of events arises.

1.1 The evolution of supply chain event management applications

First Generation Event Management Applications

First-generation event management systems are based on inventory management and shipments track and trace capabilities. These systems are able to capture single events – events are typically defined as gaps between a set and a measured level in predefined

parameters, for example low safety stock, or late delivery. The criticality of the event is directly proportional to how wide the gap is (for example how depleted is the safety stock, or how many hours/days/weeks late is a shipment). Usually the number of parameters that can be measured and therefore used for management by event is limited to a set decided by the user and set up by the software provider or system integrator.

Second Generation Event Management Applications

Second-generation event management systems add to the first-generation capabilities: they not only generate alerts for events, but they also suggest a number of actions aimed at addressing the problem and preventing disruptions, the most advanced are also capable to prioritize this list of possible actions. For example, in the case of a late inbound shipment of raw material, the system is able to offer several options of actions, such as requesting a shipment from a different supplier, or set up an expedite shipment.

Third Generation Event Management Applications

Third-generation event management software goes one step forward and offers automated functionalities as reaction to the event. For example, the system automatically sends an inventory replenishment order whenever the inventory falls below a set level.

Additionally, the most sophisticated software solutions are able to link together different software systems already in place in the supply chain, like inventory planning, shipment track and trace, and customer relationship management. In this case, if an event alert regarding a late shipment is generated, the system may be able to cancel the late order, automatically switch to a new supplier, set up the shipment with a preferred carrier, and alert key customers.

1.2 Future Generations of Event Management Applications

Even state-of-the-art event management software, however, typically has a conceptually limited and shortsighted definition of what an “event” is. Such systems

tends to lack structure and a truly supply chain oriented framework for providing an adequate definition of what an event is and a meaningful way to measure its criticality.

The purpose of this thesis project is to explore the feasibility of a next generation of event management software, based on a network analysis systems for inventory/orders, and encompassing the entire flow of inventory, information, and interactions between partners and participants, throughout the entire supply chain.

1.3 Shortcomings of present event management applications

In order for event management software to effectively support the supply chain, and be able to manage by event in a meaningful manner, there are several key factors that need to be included in the formulation of the next generation of event management applications:

1. Simply integrating different enterprise software solutions within a single company or division is often already an overwhelming task. However, building a system that can support the entire supply chain activities by event management requires much more than that. In order to enable event management capabilities throughout the entire supply chain, integration is required not only within the wall of the single corporation, but also in the “gray” areas between corporations, in the weakest links, which often are the source of the majority of problems. Inter-company ties require visibility to expand to and light the entire supply chain. Visibility alone, however, is by no means sufficient to manage a supply chain. Visibility is just the first and basic instrument for extracting information from the supply chain. The information, then, needs to be analyzed, put in perspective, referenced and compared and, finally, transformed into meaningful actions. There is need for coordination and the ability to capture and eliminate repetitions, duplications, and inefficiencies. Measured against a new paradigm, a “disruptive event” will no longer be a mere gap between set and measured levels for few

discrete parameters, but rather be a disruptive trend in inventory strategies, or a patterns of late deliveries with roots in the way the company negotiates transportation with its preferred carriers. Such a supply chain event management system assumes that supply chain's participants have the capability of capturing events, and generating and transmitting data in real time, in and across the entire supply chain. This in turn assumes the adoption of communication standards within the chain, such as XML (eXtensible Markup Language) and EDI (Electronic Data Interchange) while in the reality, many participants still rely on telephone, fax, or word and excel documents exchanged by email.

2. Current solutions are aimed at addressing local problems, with a very low level of supply chain coordination. Presently the main purpose of the software is to detect, and quickly address operational and day-to-day disruptions that may arise. Current solutions miss a reference structure and cannot fully evaluate the impact that the problem considered may have at a higher level in the supply chain. While a delay in a single shipment is disruptive, a trend of repeated smaller delays may be much more harmful for the supply chain, and impossible to detect with the present event management instruments. In the currently available software, the criticality of an event occurring in specific segment of the supply chain is simply measured as a gap against set levels. For example, if safety stock falls below a set level, the supply chain event management system will trigger an alert, send it to the process owner at the appropriate level, or even automatically react with an action (such a replenishment order) to replenish safety stock. However, the system is not capable of measuring the event against a supply chain framework, and there is no instrument to evaluate the criticality of that event over the entire supply chain flow. Without a holistic view of a supply chain, and a backbone structure that reflects this view, it becomes very difficult to meaningfully apply event management. And it becomes even more difficult to put event management into context as a tool for improving inventory management in a broad sense, linked to product lifecycle management and, at a higher level, to the long-term strategy of a company. Current solutions are not equipped to detect and evaluate

how events propagate in the supply chain, and how they affect the long-term behaviors and trends in the supply chain. In the absence of a reference system to put events into a wider SC perspective, a variation against a set level will automatically trigger an alert, even if the event were considered non-critical when measured against a comprehensive supply chain model. There is not yet a network to measure events against; there is no sense of path. There is no difference between today's crisis and long-term disruptions. In the absence of a reference frame or any other input, all events are equal and live just "today". Even in the state of the art event management solutions, there is not yet the sense of time. Thus, every event becomes critical and every event becomes a crisis, which needs to be addressed today, and which has high probability of not leaving a trace of itself.

3. Supply chain event management software capabilities are confined within a single parameter at the time (shipment delay, safety stock level, disruption/delay in production), while in reality, the supply chain acts as a living organism, where patterns and combinations of events, through coordination, ties, and correlation, cross the boundaries of different sectors and create results that may differ widely from the sum of effects created by the single events. Currently used alert systems generate alerts when a single exception occurs. Specifically, when a parameter exits an acceptability range set in accordance with the user company's policies. However, what often constitutes a trigger for an alert is not a single event, but rather, the combination of a number of events. The presence of patterns of events happening in different segments of the supply chain, simultaneously or in cascade, can lead to disruptions that cannot be prevented and avoided by monitoring single exceptions. Let's consider the following examples:
 - a) A slightly late delivery event bypasses a traditional event-management system. Accords are taken at the phone between the company's buyer and the supplier's sale force. However, the parts to be delivered are needed for the production of goods for an important client whose demand has suddenly doubled. The result of

this combination of events has a very high probability of generating a non-perfect order, while none of the single events has.

b) A delivery of raw materials is cancelled, and this event triggers a traditional exception-alert notice, or, in more advanced systems, even an automatic replenishment order. However, the materials were to be used for a client whose demand dropped significantly. Not only was the delivery cancellation not causing disruption, but it was contributing to keeping the inventory level in the correct range.

These simple examples show just a few of the limitations of a traditional exception-based alerting system. They are not flexible and “smart” enough to capture possible disruptions/improvements to supply chain processes generated by combinations of different exceptions. Additionally, human intervention – such as direct settling of a problematic event, on the phone between buyers and suppliers – often cancels any trace of the event itself. In the absence of records, it is almost impossible to identify the causes of recurring problems and address them appropriately.

Chapter 2 Literature Review

A future generation of event management systems for inventory management across the entire supply chain, as the one suggested in chapter one, should be:

- Built on the firm's industry-specific expertise and own practices' knowledge of inventory management, and capable to monitor the key inventory metrics;
- Based on project management principles and on a PERT-/CPM-like network for inventory, used as framework for putting events into a context which is meaningful for supply chain dynamics;
- Capable of leveraging the technology already developed for event management solutions, and available in the software currently offered,

2.1 Inventory parameters

In order to measure and quantify the entity of the events related to inventory, inventory parameters need to be set and included in the framework for an event management solution. Such parameters may include forecast frequency and error (to be understood in their behavior over time), planning frequency, communication efficiency between different levels of the supply chain, and any other relevant parameters affecting inventory management. Though most parameters are common to many production environments, there is not a set recipe, since specific industries, business practices, and production processes may require or even dictate some of the parameters.

In order to assess and correctly quantify the criticality of events, a number of factors need to be taken into consideration while setting the appropriate inventory parameters, such factors can grouped under different families as follows:

Product factors:

including details and features of products, at the product-family or SKU level, depending on the nature of the event management solution; product's life cycle; products' physical dimensions, weight, and packaging requirements;

Cost factors:

including factors related to products' cost, pricing, and profit margins. Factors related to cost, price, cost of labor, and margin trends play an important role in monitoring a firm's alignment between competitive strategy and internal practices;

Production factors:

including production volume, product mix, ramp up times, production time, cost, and flexibility in domains of both time and cost.

It is important to notice that in the process of building a framework able to support inventory management by exceptions, and when setting the inventory parameters, a firm should have a clear definition of its processes and align them with the inventory management strategy. Additionally, inventory parameters, and the way these parameters are measured, reflect not only the nature of a firm's business, products, and processes, but also strategic choices, such as the way the firm wants to compete. Low cost, speed-to-market, quality, and flexibility, are all different domains for competition, and each of them requires a special treatment of inventory, and a specific event management framework that establish the most important metrics, and capture relevant events and exceptions.

2.2 Project management, CPM, and PERT networks.

Project Management

Project management is defined as the coordination of groups of activities wherein the managers plan, organize, staff, direct, and control to achieve goals and objectives with constraints on time, cost, and performance of the end product¹. Project management involves coordination, and planning, as well as sequencing and scheduling of the activities and processes that lead to the achievement of the desired goals.

¹ Joseph J. Moder, Cecil R. Phillips, Edward W. Davis, (1983), "Project Management with CPM, PERT and Precedence Diagramming"

Project management applied to the flow of inventory within the supply chain implies the capability of understanding where the inventory comes from, what relationship a firm has upstream in the supply chain with its suppliers of products, sub-assemblies, services, and outsourced manufacturing. It implies also that the firm is able to correctly define the sourcing, manufacturing, and inbound and outbound logistics processes as well as the order fulfillment process downstream in the supply chain, by understanding customer requirements, expected service level, by being able to prioritize accounts by strategic importance and by knowing very well industry and competitive dynamics in its market.

Network Models and Critical Path

A network model constitutes the representation of a project as a sequence of activities each requiring a set time. In a network model² (Figure 1) all the activities preceding a given activity must be completed before the given activity commences. Each activity links an event to the following one, on a given path. In the sequence of activities, while some of them are exactly timed, others have a certain *slack* or *float time*, which means that they can be completed prior to the occurrence time of their succeeding activities.

In a supply chain model, for example, it makes a significant difference if the same event occurs in a slack path (possibly no delay for the rest of the supply chain) or in a non-slack path (in which case all the activities after that will be impacted).

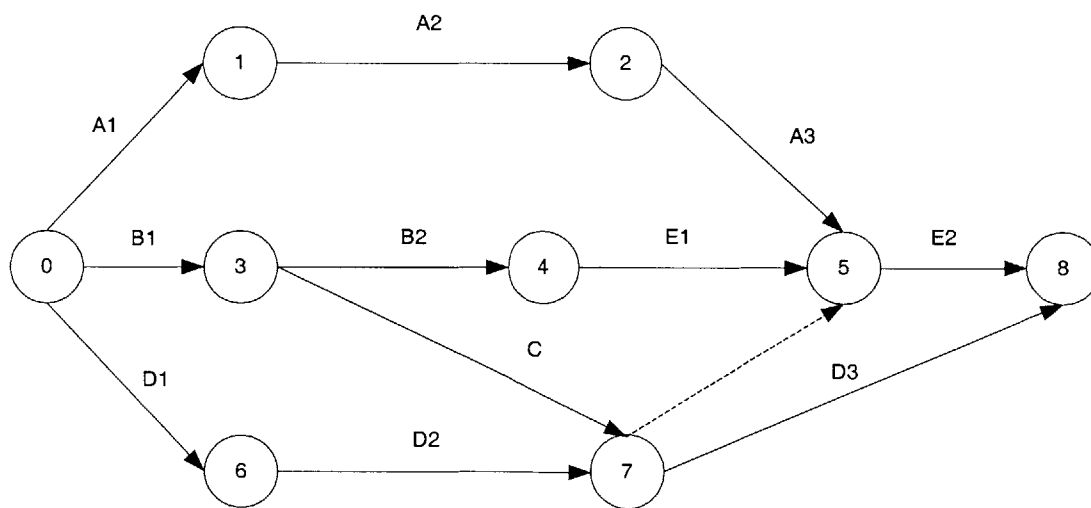

² Joseph J. Moder, Cecil R. Phillips, Edward W. Davis, (1983), "Project Management with CPM, PERT and Precedence Diagramming"

Figure 1, Project network³

Figure 1 represents a very simple model of a project network. Each line represents an activity, which needs to be completed before the following activity begins. Each circle represents an event. Each activity is characterized by a set of parameters such start time, end time, duration, and resources.

Figure 2, Time-scaled network⁴

Figure 2 represents the same project using a different representation called Time-scaled network. The dashed lines represent activities that could be completed before the occurrence time of the following ones (slack paths).

In a network model, the *critical path* is defined as the longest path in the network. Depending upon the segment of the network where they occur, events and disruptions in the network can lead to different outcomes, from no consequences, to major delays and the definition of a new critical path.

³ Joseph J. Moder, Cecil R. Phillips, Edward W. Davis, (1983), "Project Management with CPM, PERT and Precedence Diagramming"

⁴ Joseph J. Moder, Cecil R. Phillips, Edward W. Davis, (1983), "Project Management with CPM, PERT and Precedence Diagramming"

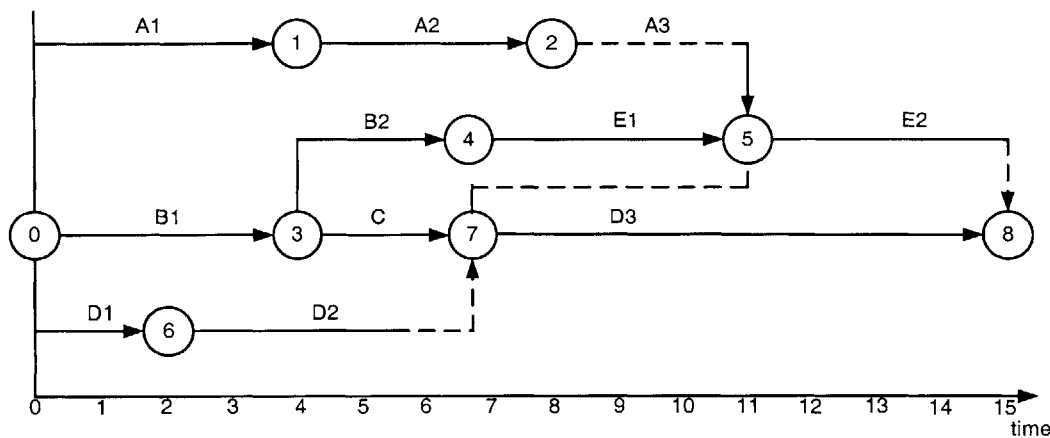
In Figure 2, the sequence B1-C-D3 represents the critical path for this network, in fact none of the activities on this path has float time.

Network-based Project Management

Network-based project management enable a systematic approach to project management and includes a clear sequences of actions aimed at creating a complete project schedule that takes into account actions, processes, resources, and boundary conditions. Network-based project management methodology includes the following steps:

1. **Project planning:** defining the activities, and their technological dependence. In a supply chain event management system perspective, this translates into looking at the entire supply chain, clearly defining the processes, and deciding which parameters need to be measured.
2. **Time and resource estimation:** each activity needs to be based on available manpower and equipment. In an event management system context, this implies assigning time estimates to each segment of the inventory path, from suppliers or tiers of suppliers, to end customer.
3. **Basic scheduling:** setting the earliest, latest allowable start and finish times for each activity, and as a byproducts, they define the critical path within the network, and set the slack or float time associated with non-critical paths. The critical path in the supply chain is now set, and with it the slack associated to selected activities. Events are not all equally important. Their criticality now is associated to the activities they affect.
4. **Time-cost trade-offs, evaluation of the resource constraints.** In a supply chain environment, events are put into context; the choice of possible action involves

trade offs that have deep roots in the strategy of the firm for inventory, pricing and competition.

5. Resource allocation: manpower and equipment constraints
6. Project control (time and cost): the schedule is used to measure the actual project. Whenever major changes are required in the schedule, the network is revised accordingly and a new schedule is computed (see time control in chp 4, biblio 3). This will be a core part of future event management solutions.

PERT

The Project Evaluation and Review Technique (PERT) statistical approach to network modeling introduces probability theory in the management decision-making process. PERT and Critical Path Method (CPM) are based on the same network setup, the PERT system, however, uses a probabilistic approach to the time estimate for the activities.

Given the mean as measure of central tendency of n measurements of the time duration of an activity:

$$(2.1) \quad \bar{t} = \frac{(t_1 + t_2 + \dots + t_n)}{n}$$

and the standard deviation as measure of variability:

$$(2.2) \quad s_t = \sqrt{\frac{(t_1 - \bar{t})^2 + (t_2 - \bar{t})^2 + \dots + (t_n - \bar{t})^2}{n}}$$

\bar{t} approaches t_e , the expected time of completion of a given activity, for a sample of measures that approaches infinity, and similarly, s_t approaches the square root of the variance $V_t^{1/2}$.

The PERT methodology then leverages the central limit theorem: given m independent tasks to be performed in sequence; t_m the actual time required to complete each task; V_{tm} the actual variance associated with each t_m (V_{tm} and t_m are unknown until the task is performed), and T defined as follows:

$$(2.3) \quad T = t_1 + t_2 + \dots + t_m$$

(T is also a random variable), then for m large enough, the distribution of T is approximately normal with mean E and variance V_T given by:

$$(2.4) \quad E = t_{e1} + t_{e2} + \dots + t_{em}$$

$$(2.5) \quad V_T = V_{t1} + V_{t2} + \dots + V_{tm}$$

the mean of the sums is the sum of the means, the variance of the sum is the sum of the variances, and the distribution of the sum of activity times will be normal regardless of the shape of the distribution of actual activity performance times.

PERT uses three time estimates for each activity, an optimistic, a likely and a pessimistic estimate. This range of estimates provides a measure of the uncertainty associated with the actual time required to perform the given activity. The estimated time for a given activity, in PERT is counted as a weighted average of the quantities:

t_o = the most *optimistic* estimate (5% percentile)

t_m = the most *likely* estimate (modal estimate)

t_p = the most *pessimistic* estimate (95% percentile)

as follows:

t_e = estimated time for the activity

$$(2.6) \quad t_e = \frac{(t_o + 4t_m, t_p)}{6}$$

$$(2.7) \quad Vt = \left[\frac{(t_p - t_o)}{3.2} \right]^2$$

The variance V_T is computed with the following rules:

- V_T for the initial event is set to 0
- V_T for a generic, non-merge event in the network is calculated as the sum of the activity variance V_i and the precedent event variance.
- V_T for a merge event is calculated as the sum of the activity variance V_i on the longest path, in the case of ties, we use the path with the larger variance.

The central limit theorem allows the assumption that the shape of the distribution of T is approximately normal, therefore probabilities can be attached to each possible outcome for the project completion.

2.3 Existing event management software

Several firms have addressed the need for event management software. The following list includes some well-known names in the enterprise software industry:

Categoric Software

The company's product, Xalerts, enables monitoring, notification, detection, and response to business critical events in real time. Criticality, however, seems to be measured again against fixed levels rather than put into a holistic supply chain context.

Eventra

Eventra software's event management strength lies in supply chain visibility and data availability, especially related to the enterprise inbound flow.

J.D. Edwards

According to Andy Carlson, J.D. Edwards' director of supply chain product marketing "Inventory arrives. It's damaged in shipment. The receiving dock barcodes it and says 'not acceptable.' So you move it to a hold area and [the SCEM system] triggers a replenishment order and sends a notification to the customer service person handling it."⁵

Optum

Optum solution is focused on inventory visibility, with track and trace functionality, and a strong operational flavor. However, there is no mention of complex event management and of a structure able to support more than a traditional alert system triggered by inventory levels and delays in shipment/production/order fulfillment.

⁵ <http://www.line56.com/articles/default.asp?ArticleID=4324>

Rely Software

Rely Software's event management piece enables a traditional exception-based management for selective notification based on custom criteria.

SAP

Event management enabled by track and trace functionality, that leverages single event alerts, based on a deviation from set parameters, for execution decisions.

Silvon Software

This company focuses on business analytics, and event management is seen as an instrument for visibility. However visibility is not put into a context or framework that allows determining and quantifying the criticality of the event.

Vigilance

Vigilance Event Management uses real-time monitoring agents to detect operational issues, such as orders that are at risk of shipping late or inventory that is about to run out, and to immediately alert all relevant participants in the supply chain community. Through automated escalation and web-based tracking, collaboration and closed loop control, members of the extended supply chain are able to resolve operational issues before they result in excess cost or lost revenue.

Viewlocity (Tilion)

The company Web-enabled application focuses on visibility and supply chain collaboration, as stated in the company's Web site: "...enabling users to view the most up-to-date information about the state of their supply chain, to collaborate with other users about exceptions and issues, to rapidly respond to exceptions ...". Still there is no mention of a more complex event management structure able to self-assess event criticality as measured against a more complex supply chain model.

Vizional (Saltare)

Vizional's software focuses on execution, track and trace capabilities, inventory visibility, and traditional event management functionality.

Chapter 3 Development of the Concept

In order to understand how to implement project management and PERT techniques in a supply chain event management context, we have approached the problem from two different point of view:

- Analysis of a single order fulfillment process: the order comes into the firm and triggers a sequence of inter-related activities that ends with the customer receiving a shipment. This approach explores some of the supply chain dynamics through the lens of the single order, which replicates, in miniature, how the inventory moves in the out-bound chain. We have labeled it “micro-dynamic” approach.
- A second approach, labeled as “macro-dynamic” approach, includes a PERT model of the inventory itself, modeling the flow of goods and information in the supply chain.

It’s important to notice that the purpose of these two approaches is not to provide detailed PERT networks of the order fulfillment process and supply chain inventory management, but rather to show the potential advantages of a supply chain event management framework that exploits the strength of such project management tools.

An additional section is dedicated to how it is possible to leverage data collected through event management activities to support and improve the PERT network itself — by gathering reliable inputs for the time estimates — and provide a solid repository for building a firm’s in-depth knowledge of supply chain trends and dynamics, through the analysis of meaningful data.

3.1 Micro-dynamics approach: a network path for the order fulfillment process

The order fulfillment process has been selected for a first approach to the use of a PERT methodology in an event management context. The idea is to build a network that identifies a critical path and see how to measure events against the network scheme.

Figure 3 shows a simplified project network model of a single order fulfillment. Nine main nodes have been specified, numbered from zero to eight, and each node is connected to the following one(s) by activities.

Nodes	
0	Order received
1	Credit check done
2	Warehouse check done
3	Transportation arranged
4	Packaging done
5	Documentation ready
6	International documentation ready
7	Shipment loaded
8	Shipment received

Figure 3. PERT micro-system, nodes definition

Each activity is noted with the three estimate of completion time (optimistic estimate, 5% percentile, median estimate, and pessimistic estimate, 95% percentile).

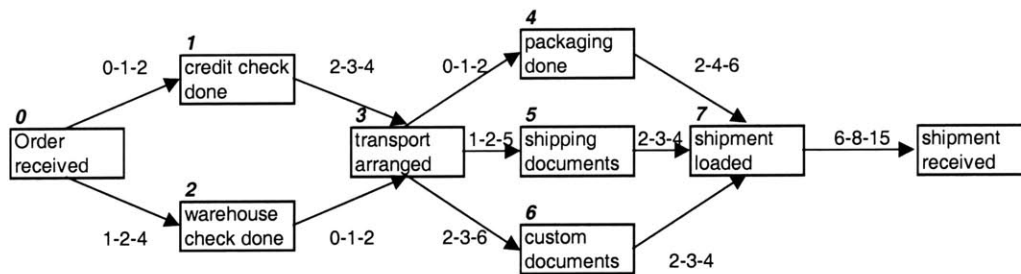

Figure 4. PERT project network for the order fulfillment

The following table shows the data for this simple model, including time estimates, mean, t_e , and variance, V_t , for each activity; t_e , and V_t have been calculated according to the expressions (2.6) and (2.7) in Chapter 2. Values of t_o , t_m , and t_p in this specific example, are arbitrary.

Activities			o	m	p		te	Vt
from node to node			[days]				[days]	
A 1	0	1	0	1	2		1	0.39
A 2	0	2	1	2	4		2.17	0.88
A 3	1	3	2	3	4		3	0.39
A 4	2	3	0	1	2		1	0.39
A 5	3	4	0	1	2		2.33	1.56
A 6	3	5	1	2	5		3.33	1.56
A 7	3	6	2	3	6		4	1.56
A 8	4	7	2	4	6		4	1.56
A 9	5	7	2	3	4		3	0.39
A 10	6	7	2	3	4		3	0.39
A 11	7	8	6	8	10		8	1.56

Figure 5: Micro-system activities table

Given the values in the previous table, each node is characterized by the following values of E (estimate of the total time up to the given node) and V_T , overall variance at the given node:

Node	E	VT	St.Dev
0	0.00	0.00	0.00
1	1.00	0.39	0.63
2	2.17	0.88	0.94
3	4.00	0.78	0.88
4	6.33	3.11	1.76
5	7.33	2.34	1.53
6	8.00	2.34	1.53
7	11.00	2.73	1.65
8	19.00	4.30	2.07

Figure 6: estimate of time and variance for each node

The critical path, characterized as the longest path in the system: the path is given by the sequence of nodes: 0-1-3-6-7-8 (Table 2).

By applying a “micro-dynamics” PERT technique we can associate to every order its own specific network path, were the determination of the duration times t_o , t_m , and t_p depends on values known from past orders, as well as on the nature of the specific order,

importance of the account, and present business conditions. A problem is critical if it implies a delay for the customer. For one order the documentation can be on the critical path, while for another it can be transportation, or warehouse constraints, or outsourced production. An event is not critical if there is slack that allows for delays in the process with no delay for the final customer. Events can be then sorted based on the path where they occur, that path's criticality, and the consequences that events bring to the overall system critical path.

Given the normal distribution of the project completion time, under the PERT assumptions, it is also possible to calculate the probability to complete the project — fulfillment process in the case of the example — on time, or on a given day before or after the expected completion time, assuming that there are no changes in the critical path. For the fulfillment process example, the expected completion time is 19 days, and figure 6 shows the probability of completing the process in different completion times, from 15 to 25 days.

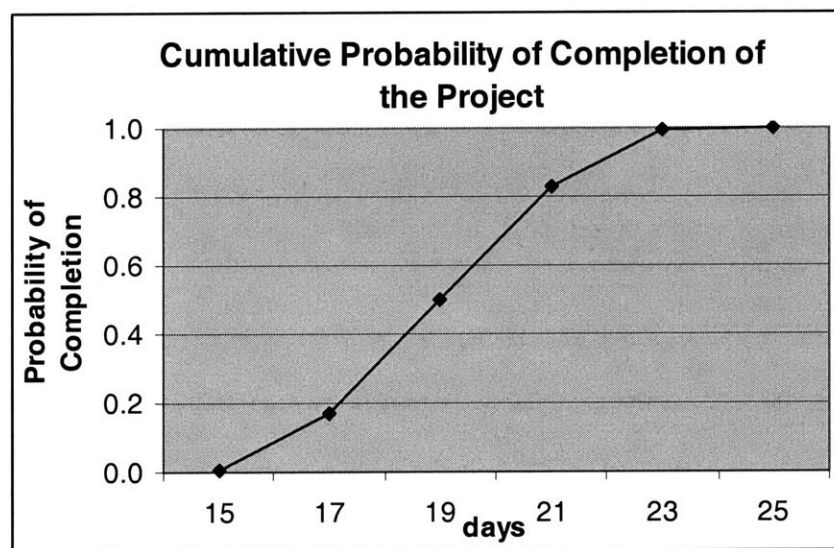

Figure 7. Probability associated with the completion time estimate

3.2 Macro-dynamics approach: a network path for inventory management

Inventory is the second element that we tried to model with a PERT network in an event management context. The organizing concept in this case is the maintenance of inventory, considering all the activity that happens in a network to plan, replenish, and manage inventory. Figure 7 shows a simplified project network model of inventory. Eight nodes, numbered from zero to seven, compose the network.

Nodes	
0	Replenishment orders for parties and subassemblies are sent out
1	Parts and materials are in, ready for use in production
2	Subassemblies are in, ready for use in production
3	Production begins
4	Production ends
5	Finished goods distributed directly reach the distribution centers
6	Finished goods distributed directly reach warehouses
7	Finished goods reach customers

Figure 8. PERT macro-system, nodes definition

The notation follows the previous model and each activity is noted with the three estimate of completion time (optimistic estimate, 5% percentile, median estimate, and pessimistic estimate, 95% percentile).

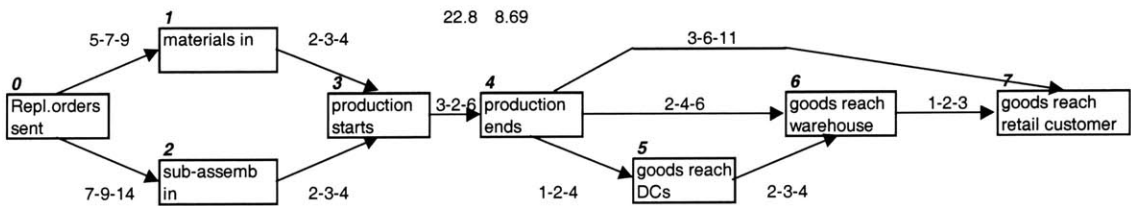

Figure 9. PERT project network for a basic inventory management model

The following tables show time estimates, mean, t_e , and variance, V_t , for each activity. t_e and V_t have been calculated according to the expressions (2.6) and (2.7) in Chapter 2. Values of t_o , t_m , and t_p in this specific example, are again, arbitrary.

Activities:			o	m	p		t_e	V_t
from node		to node	[days]				[days]	
A 1	0	1	5	7	9		7	1.56
A 2	0	2	7	9	14		9.5	4.79
A 3	1	3	2	3	4		3	0.39
A 4	2	3	2	3	4		3	0.39
A 5	3	4	2	3	6		3.33	1.56
A 6	4	5	1	2	4		2.17	0.88
A 7	4	6	2	4	6		4	1.56
A 8	4	7	3	6	11		6.33	6.25
A 9	5	6	2	3	4		3	0.39
A 10	6	7	1	2	3		2	0.39

Figure 10: Macro-system activities

Given the values in the previous table, each node is characterized by the following values of E (total time up to the given node) and V_T , (overall variance at the given node):

Node	E	VT	St.Dev
0	0.00	0.00	0.00
1	7.00	1.56	1.25
2	9.50	4.79	2.19
3	12.50	5.18	2.28
4	15.83	6.74	2.60
5	18.00	7.62	2.76
6	21.00	8.01	2.83
7	23.00	8.40	2.90

Figure 11: estimate of time and variance for each node

The critical path, characterized as the longest path in the system: the path is given by the sequence of nodes: 0-2-3-4-5-6-7 (Figure 9).

Figure 11 shows the probability to complete the project on time — an inventory cycle from replenishment order to finished goods to the retail customer, in the case of the example — or on a given day before or after the expected completion time, assuming that there are no changes in the critical path.. For the given example, the expected completion time is 23 days, and figure 6 shows the probability of completing the process in different completion times, from 17 to 33 days.

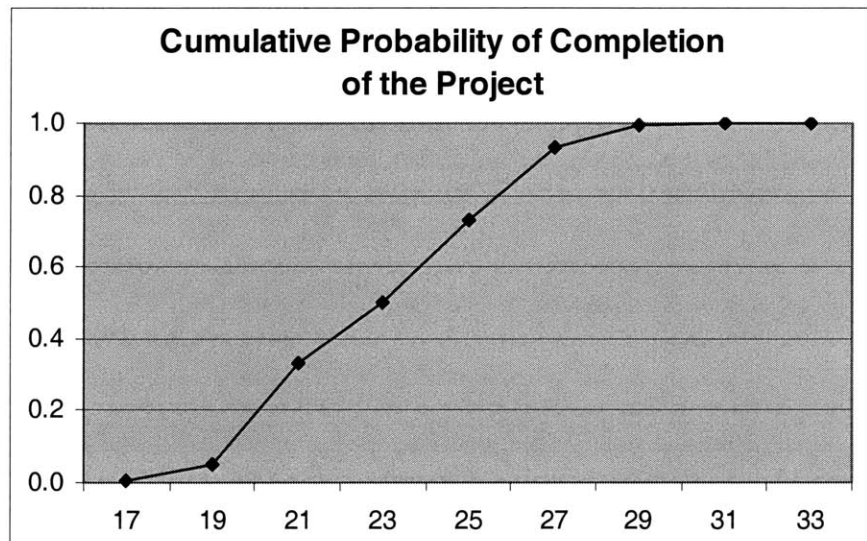

Figure 12. Probability associated with the completion time estimate

The determination of the critical path allows us to divide supply chain events (both in the micro- and macro-system examples) in three main categories:

1. Events that do not introduce delays in the overall project. Such events will occur in paths with slack, and the delay that they bring is smaller than the slack time, therefore these events neither delay the overall process, nor define a new critical path;
2. Events that fall on the critical paths, and therefore introduce delays in the overall project, but without changing the critical path. The delays introduced from such events will always propagate in the supply chain and lead to an overall process

delay, but the sequence of activities that determines the critical path does not change; and

3. events that fall into slack paths and introduce delays larger than the allowed slack, therefore generating new critical paths. Such events change the sequence of activities that lie on the critical path and design a new critical path.

3.3 Memory of past events: turning event management into a tool for monitoring mid-and long-time strategic goals.

A very important part of a PERT framework in a supply chain event management context is a repository storing information about past events. Such a resource, which has the function of “memory” for the event management system, will be used for assessing the probability of delays based on past events. The information about past events, generated by the system, and stored in the repository, can provide data for setting the parameters t_o , t_m , and t_p for each path in the network.

Additionally, the information, and the behavior of the changes of critical paths can be used to categorize and understand mid- and long-term patterns and trends, versus short-term fixes, and understand the roots of the problems.

For example, from a high frequency of events in an inbound transportation path, rather than simply extracting the frequency of late shipments, which does not necessarily have an operational relevance, we can extract the following information:

- What percentage of late shipments is disruptive, and generates an overall delay to the supply chain (because they either fall on a critical path, or on a path with slack and the delay exceeds the slack);
- What percentage of these disruptive delays can be associated with specific causes, such as the choice of carrier, or supplier;

- How the expected time of completion in a path evolves in time, and how performance of suppliers of parts and services can affect the probability of performance in specific paths, especially in critical ones.

Chapter 4 Conclusions and Findings

4.1 Key Findings

These are some of the key findings that emerge from the analysis of the adoption of a PERT-based network for inventory to be used in supply chain event management:

1. A definition of “criticality” is key to have effective supply chain management by events. Project-management based frameworks, like the one developed in this project thesis, should be used as a base for building an event management system with a clear and well-defined concept of criticality embedded in it;
2. Not all events are equal. There are multiple dimensions to define the relevance and criticality of an event. Presently available solutions are able to exploit one single dimension: the gap between a planned level and an actual one. However, a useful and operationally sound definition of criticality should also include the effects and repercussions of that delay into the supply chain, and link the event to the changes that may be created in the critical path;
3. Such networks do not simply compare set levels of certain parameters, but rather “learn” from the past. Past events contribute to the computation of path completion estimates and associated probability, thus they are instrumental in defining the probability of future events and determining the critical path (which depends on longest paths in first place and on largest variances as second element for choices);
4. When an event changes the critical path, by affecting an activity with slack time and exceeding the available slack, then a new critical path will be determined in the network. In this case, “criticality” can shift to new areas of the supply chain, with consequences that can be located very far from the path where the event

happens. A project management definition of criticality and a holistic view of the supply chain can help put events into a context and monitor the “critical” part and paths in the supply chain.

5. When the attention shifts from looking at gaps between expected and measured parameters, to considering the consequences of an event throughout the entire supply chain network, then event management becomes a way to gain insight into supply chain dynamics and a tool to understand and strategically manage the supply chain, rather than “fix” problems locally;

All these elements lead to a division of events in four major families:

- Events that do not bear supply chain-wide consequences: these are events that happen in activities with slack times, and introduce perturbation with a duration shorter than the available slack.
- Events that introduce time delays in the supply chain: these are events that falls on the critical path (which is the longest path in the network), therefore, whatever delay they introduce, will propagate throughout the entire network;
- Events that define new critical paths: these events not only introduce delay in the network, but also re-define the concatenation of paths that form the critical one. Such events introduce substantial changes in the network and shift criticality to new activities that can suddenly assume a different meaning for the overall supply-chain.
- “New” events: the definition of what a “critical event” is can be expanded beyond a single occurrence of a gap between a set and a measured level (in inventory, safety stock, transit time). The new definition includes patterns in demand and supply, changes in probabilities, opportunities of bundling, and a number of other elements that can influence a path criticality

4.2 What is needed to get there

Is it possible to implement such a system? In most cases the answer is: not yet. Or at least, not at a supply-chain wide level. Yet, even partial implementations of systems driven by such project-management network models represent a significant improvement over presently available supply chain management systems. What then is needed and may not yet be there?

1. A central repository for supply chain information. As said, not all events are equal and they can impact the supply chain in very different way, especially patterned and repeated events. Dramatic changes in critical path can suggest the need for changes in a firm's strategic approach to certain areas of the supply chain. Analysis and understanding of such changes can guide high-level decisions, such as outsource vs. manufacture, internal fleet vs. external carrier among others. The first step, however, is to be able to capture such event-related information and trends, in a central repository that can function as a "memory" for the entire system.
2. More informatization in the supply chain. If activities included in the critical path involve parties (such as suppliers, transportation provider, contract manufacturers, customers, among others) that are not able to link their IT system to the event management system, there may be severe limitation to the purpose and scope of an event management system.
3. Access to past event-related information. The central repository has the multiple functions of central unit for the coordination of supply chain event management trigger system, of source for the PERT network path completion time estimates, and of storage point for event logs, which can then be retrieved and used for analytics and data mining activity.

4. Internal company barriers can put limitations to what can be done with an event management system. The layout of a frame system for supply chain event management requires coordination and inclusion of strategic, tactical, and day-to-day activities, keeping into account the entire supply chain and the firm's overall strategy. It is important that all the parties involved make their contribution, because that will determine the definition of critical paths.

Bibliography

- 1) David I. Cleland, William R. King, (1968), "System Analysis and Project Management", McGraw-Hill Series in Management, ISBN 0-070-11310-6
- 2) Dennis Lock, (1996), "Project Management", Wiley, ISBN 0-470-23723-6
- 3) Joseph J. Moder, Cecil R. Phillips, Edward W. Davis, (1983), "Project Management with CPM, PERT and Precedence Diagramming", Van Nostrand Reinhold Company, ISBN 0-442-25415-6

Web sites:

Categoric Software	http://www.categoric.com , March 2003
Eventra	http://www.eventra.com , March 2003
J. D. Edwards	http://www.jde.com , March 2003
Optum	http://www.optum.com , March 2003
Rely Software	http://www.relysoftware.com , March 2003
SAP	http://www.sap.com , March 2003
Silvon Software	http://www.silvon.com , March 2003
Vigilance	http://www.vigilance.com , March 2003
Viewlocity	http://www.viewlocity.com , March 2003
Vizional	http://www.vizional.com , March 2003
Line 56	http://www.line56.com/articles/default.asp?ArticleID=4324

List of Acronyms

CPM	Critical Path Method
CRM	Customer Relationship Management
DRP	Distribution Resource Planning
EDI	Electronic Data Interchange
ERP	Enterprise Resource Planning
MRP	Material Resource Planning
PERT	Project Evaluation and Review Technique
SC	Supply Chain
SCEM	Supply Chain Event Management
XML	eXtensible Markup Language

6572-34