

**ASSEMBLY ORIENTED DESIGN:
CONCEPTS, ALGORITHMS AND COMPUTATIONAL TOOLS**

by

Ramakrishna Mantripragada

Bachelor of Technology, Mechanical Engineering,
Indian Institute of Technology, New Delhi, May 1992

Master of Science, Mechanical Engineering
The Ohio State University, June 1994

Submitted to the Department of Mechanical Engineering
in Partial Fulfillment of the Requirements for the Degree of

Doctor of Philosophy in Mechanical Engineering

at the

MASSACHUSETTS INSTITUTE OF TECHNOLOGY

February, 1998

© Massachusetts Institute of Technology, 1998
All Rights Reserved

Signature of Author_

Department of Mechanical Engineering
December 12, 1997

Certified by_____

Professor Warren P. Seering
Chairman

Certified by_____

Dr. Daniel E. Whitney
Thesis Supervisor

Accepted by_____

Professor Ain A Sonin
Chairman, Department Committee

APR 27 1998

ARCHIVES

LIBRARIES

To my parents

Assembly Oriented Design:
Concepts, Algorithms and Computational Tools
by
Ramakrishna. Mantripragada

submitted to the Department of Mechanical Engineering
on December 12, 1997 in partial fulfillment of the
requirements for the degree of Doctor of Philosophy
in Mechanical Engineering

ABSTRACT

Most complex assemblies consist of many individual sub-assemblies and parts that are designed and made by different suppliers at different locations. Fit-up problems are often discovered during final assembly when trying to put these parts and sub-assemblies together. Finding the source of these fit-up problems is a very difficult and time-consuming task, and most of the time the exact causes cannot be identified. Early anticipation and avoidance of these problems can have a huge impact in reducing the product development time, cost, and production fit-up problems, and can improve final product quality.

Most fit-up problems occur due to a choice of assembly procedures that are not consistent with the dimensional and tolerance logic used to design the parts. During these early stages of design, it is essential to: (a) Identify and systematically relate design requirements (Key Characteristics, KCs) to important datums on parts and fixtures at the various assembly levels (b) Design the dimensional and tolerance relationships among elements of an assembly (locating schemes) from these KC relationships (c) Identify assembly procedures that best deliver the KCs repeatedly without driving the costs too high. Current CAD systems do not support this approach to designing assemblies and encourage premature definition of part geometry, allowing designers to skip the consideration of these elements.

The thesis presents a conceptual framework to model and evaluate assemblies and their assembly procedures for future CAD systems. Graphical representations of the assembly are developed to represent a hierarchical model of the assembly. We call this graph the "Datum Flow Chain" which is used to drive the assembly design process. DFCs express the designer's logical intent concerning how parts are to be related to each other geometrically to deliver the KCs repeatedly. The intent is the locating scheme and is captured in the DFC. The DFC relates the key characteristics of the assembly to the hierarchy of locating and assembling parts and fixtures. The imposed hierarchy is used to plan assembly sequences, choose mating features and design fixturing options. Properties of graphs from graph theory are exploited to formalize the representations and define algorithms to evaluate the graph. Two types of assemblies are addressed: Type-1 where the assembly process puts parts together at their pre-fabricated mating features and Type-2 where the assembly process can incorporate in-process adjustments to redistribute variation. Four classes of variation problems are identified for these two types of assemblies. In this work, the assembly process is modeled as a linear discrete event dynamic system. Algorithms are developed to determine and control variation in final assembly propagated through the combined effect of individual part variations and choice of assembly

methods. An optimal control problem is formulated to develop a scientific approach to designing assembly features in Type-2 assemblies. Variation associated with final assembly dimensions, cost of making adjustments, and assembly sequence effects are included in the optimization procedure. Some of the new techniques developed as a part of this research have been successfully applied to study the assembly of a fuselage section and horizontal stabilizer of major aircraft assemblies.

Dr. Daniel E. Whitney: Thesis Supervisor

BIOGRAPHY

December 12, 1971	Born- Amalapuram, India.
May, 1992	Bachelor of Technology, Mechanical Engineering Indian Institute of Technology, New Delhi, India.
June, 1994	Master of Science, Mechanical Engineering The Ohio State University, Columbus, OH, USA. Master of Science in Manufacturing Systems Engineering The Ohio State University, Columbus, OH, USA.

SELECTED PUBLICATIONS

R. Mantripragada and D. E. Whitney, "Datum Flow Chain: A Systematic Approach to Assembly Design and Modeling", *Submitted to Research in Engineering Design 1997*.

R. Mantripragada and D. E. Whitney "Modeling and Controlling Variation Propagation in Mechanical Assemblies using State Transition Models." *Submitted to IEEE Trans. on Robotics and Automation 1997*.

R. Mantripragada and D. E. Whitney "State Transition Models of Mechanical Assembly Processes." *Submitted to IEEE Trans. on Robotics and Automation 1997*.

R. Mantripragada, T. Cunningham and D. E. Whitney. Assembly Oriented Design: a new approach to designing assemblies. *Product Modeling for Computer Integrated Design and Manufacture*. M. J. Pratt and R. D. Sriram. 19-23 May 1996, Airlie, Virginia, USA., Chapman & Hall: 308-324.

T. Cunningham, R. Mantripragada, D. Lee, A. Thornton and D. Whitney "Definition, Analysis, and Planning of a Flexible Assembly Process". *Japan/USA Symposium on Flexible Automation*, Boston, USA., ASME.

Mantripragada, R., Kinzel, G., and Altan, T., A CAE system for feature based design of box-type sheet metal parts, *Journal of Material Processing Technology 1996*, Elsevier Publications.

Development of Computer Aided Engineering System for Feature Based Design of Box-Type Sheet Metal Parts, *M.S. Thesis*, Department of Mechanical Engineering, May 1994, The Ohio State University, Columbus, OH, USA.

Mantripragada, R., Sengupta, S., Rao, J. S., and Rao, P.N., CAMSOFT: An interactive computer software for design and manufacture of plate cams, *Proc. of the 35th Congress of the Indian Society of Theoretical and Applied Mechanics*, 19-22 Dec. 1991, Anna University, Madras, India.

TEACHING EXPERIENCE

Massachusetts Institute of Technology, Sep.-Dec. 97

Teaching assistant, Helped create and teach a new course in the department of Mechanical Engineering: Mechanical Assembly and Its Role in Product Development.

The Ohio State University, Sep. 1992- Aug. 1993

Teaching Assistant. Taught and prepared labs for senior level mechanical engineering courses: Principles of Automatic Controls, Heat Transfer, Electrodynamics and System Dynamics, Applications of Computer Graphics to Kinematic Synthesis and Analysis.

RESEARCH EXPERIENCE

Massachusetts Institute of Technology, July 94 - Jan 98

Research assistant, Computer Aided Design Laboratory; Center for Innovation in Product Development

Projects: MIT Fast & Flexible Manufacturing Project, Advanced Collaborative Open Resource Network (ACORN) Project

The Ohio State University, Sep 93-May 94

Research assistant, Engineering Research Center for Net Shape Manufacturing

RESEARCH INTERESTS

Product development, CAD, Assembly Modeling, Manufacturing Processes

"Those who educate children well are more to be honored than parents, for these only gave life, those the art of living well."

- Aristotle

ACKNOWLEDGMENTS

This research work is a culmination of a pursuit, that involved the time, and efforts of many people, whom I wish to acknowledge. First and foremost, I wish to express my deepest appreciation and gratitude to Dr. Dan Whitney. Over the past few years, Dan has been an advisor, mentor, guardian and a role model to me. I am very fortunate to have been associated with him and my training under Dan will be valuable throughout my life. Very early in my Ph.D. years, I realized that every conversation I had with him would be filled with rich insights, depth and knowledge. He helped me focus my thoughts and put me on the right path.

I would like to thank Prof. Warren Seering and Prof. Kevin Otto for serving on my committee and for their contributions to my education. Their guidance and enthusiasm were a constant source of encouragement.

I have met some incredible people at MIT and have always learnt something from everyone I have met. Here I have made some friends for life who have given me memories I shall cherish forever. I would like to thank my fellow cadlabbers Nicola, Manuel, Naren, Maria, Francis, Ashley, Nick, Alok, Chun Ho, Jun Beom, Kazu, Minho, Jay, Paul, Rahul and Dave for making my stay in the Cadlab memorable. I will never forget you guys. I would also like to thank Tim, Jeff, and other students in the Agile program. Guys, it was great fun working with you all. Jeff, I will always remember our stay at Seattle and Nagoya. It was a great experience. And thanks for proof-reading my thesis. Kots, Srihari, and Ganti: you guys have made my stay at MIT great fun.

This pursuit would have been incomplete without the constant support and encouragement from my family. Dad, I have done it! As you wished, I have completed my Ph.D. at 25. Your principles, expectations and love have been instrumental in shaping me all these years. Mom, without your prayers and blessings, I wouldn't be what I am today. I would like to express my deepest appreciation to my sister, jijajee, bhabhi and particularly my brother for their love and support. My brother, Srini has been my iron-man of support and has always been there for me all these years. Life would be incomplete without you.

The research described in this document was supported by the U.S. Airforce Grant F33615-94-C-4429 under the MIT Fast and Flexible Manufacturing Project. This project has given me the opportunity to work at Boeing, Ford, GM and Kawasaki Heavy Industries. These experiences have added a unique dimension to my learning at MIT. I am thankful to Tim Copes and Ted Helvig of Boeing for hosting us at Boeing. My research was also supported by Advanced Collaborative Open Resource Network (ACORN) Project under Air Force contract: F33615-94-

C-4450. The gracious support under these contracts is greatly appreciated. I would also like to express my gratitude to the Ford Motor Company and Charles Stark Draper Laboratory for their support.

Table of Contents

1. INTRODUCTION	19
1.1 MOTIVATION AND GOALS	19
1.2 PROBLEM STATEMENT	23
1.3 ORGANIZATION OF THESIS	23
2. RELATED WORK.....	27
2.1 OVERVIEW	27
2.2 ASSEMBLY MODELING AND DESIGN	27
2.2.1 <i>Assembly representation and analysis</i>	28
2.2.2 <i>Assembly sequence consideration</i>	30
2.2.3 <i>Integrated computer tools</i>	31
2.2.4 <i>Discussion</i>	32
2.3 VARIATION PROPAGATION ANALYSIS IN ASSEMBLIES	33
2.3.1 <i>Tolerance analysis</i>	33
2.3.2 <i>Tolerancing and assembly process</i>	33
2.4 SUMMARY	35
3. ASSEMBLY ORIENTED DESIGN.....	37
3.1 OVERVIEW	37
3.2 TYPES OF ASSEMBLIES AND ASSEMBLY PROBLEMS.....	39
3.2.1 <i>Type-1 assemblies</i>	39
3.2.1.1 <i>Assemblability problems</i>	40
3.2.2 <i>Type-2 assemblies</i>	42
3.2.2.1 <i>KC deliverability problems</i>	44
3.3 EXAMPLE ASSEMBLY PROCESS STUDIED: "FIXTURE-LESS" AIRCRAFT ASSEMBLY	46
3.4 SUMMARY OF SCIENTIFIC ISSUES	47
3.4.1 <i>Need for a "Circuit Diagram" for Assemblies</i>	47
3.4.2 <i>Need for a "Layout Language" for Representing Assembly-level Requirements</i>	47
3.4.3 <i>Need to Model Effects of Assembly Sequence</i>	48
3.4.4 <i>Need for Way to Include Fixtures in Assembly Models</i>	48
3.4.5 <i>Need to Model Incomplete Assemblies</i>	49
3.5 APPROACH	49
3.6 SUMMARY.....	52
4. DATUM FLOW CHAIN.....	53
4.1 OVERVIEW	53
4.2 DATUM FLOW CHAIN.....	53
4.2.1 <i>The concept</i>	53
4.2.2 <i>Assumptions</i>	55
4.2.3 <i>Properties of a DFC</i>	55
4.3 TYPES OF ASSEMBLIES	57
4.3.1 <i>Type-1 assemblies</i>	57
4.3.2 <i>Type-2 assemblies</i>	57
4.4 ASSEMBLY DESIGN AND PLANNING USING DFC	57
4.4.1 <i>Example assembly: Boeing 767 Upper skin assembly</i>	58
4.4.2 <i>Key Characteristics and DFC design</i>	61
4.4.3 <i>Decomposition and Subassembly design</i>	64
4.4.4 <i>Mating feature design: designing locating schemes</i>	67
4.4.5 <i>Assembly sequence planning</i>	69
4.4.5.1 <i>Assembly precedence constraints</i>	69
4.4.5.2 <i>Family of assembly sequences</i>	73
4.4.6 <i>Modeling fixtures in assembly operations</i>	74
4.4.7 <i>Summary of DFC properties</i>	76

4.5	EVALUATING ALTERNATE DFCs.....	77
4.5.1	<i>Decomposition and subassembly analysis</i>	78
4.5.2	<i>Variation propagation analysis</i>	78
4.5.2.1	Types of variation propagation problems in assemblies.....	79
4.5.2.2	Assemblability analysis.....	81
4.5.2.3	Type-2 variation propagation analysis.....	82
4.5.3	<i>Assembly sequence analysis</i>	84
4.6	ANALYSIS OF BOEING 777 AIRCRAFT FUSELAGE ASSEMBLY.....	84
4.7	SUMMARY.....	90
5.	STATE TRANSITION MODELS.....	93
5.1	OVERVIEW.....	93
5.2	MODELING TYPE-1 ASSEMBLIES.....	93
5.3	STATE MODEL OF TYPE-1 ASSEMBLY PROCESS.....	94
5.4	MODELING TYPE-2 ASSEMBLIES.....	101
5.5	STATE MODEL OF TYPE-2 ASSEMBLY PROCESS.....	102
5.6	SUMMARY.....	104
6.	VARIATION PROPAGATION AND CONTROL.....	107
6.1	OVERVIEW.....	107
6.2	MODELING VARIATION PROPAGATION IN TYPE-1 ASSEMBLIES.....	108
6.2.1	<i>Example study</i>	111
6.3	MODELING VARIATION PROPAGATION IN TYPE-2 ASSEMBLIES.....	114
6.3.1	<i>Variation propagation in the presence of adjustments</i>	115
6.3.2	<i>Assembly sequence analysis</i>	119
6.3.3	<i>Example study</i>	120
6.4	CONTROL OF VARIATION PROPAGATION IN TYPE-2 ASSEMBLIES.....	124
6.4.1	<i>Output Controllability</i>	124
6.4.2	<i>Performance Measure</i>	126
6.4.3	<i>Optimal Controller Design</i>	128
6.4.4	<i>Example analysis</i>	133
6.4.4.1	Problem formulation #1.....	136
6.4.4.2	Problem formulation #2.....	148
6.4.4.3	Problem formulation #3.....	150
6.5	SUMMARY.....	150
7.	IMPLEMENTATION.....	153
7.1	OVERVIEW.....	153
7.2	AOD APPROACH.....	153
7.3	SYSTEM STRUCTURE.....	155
7.3.1	<i>DFC Editor</i>	155
7.3.2	<i>Motion limit analysis (MLA)</i>	156
7.3.3	<i>Assembly Sequence Analysis software (ASA)</i>	158
7.3.3.1	Assembly Sequence Generation.....	158
7.3.3.1.1	Geometric Precedence Constraints (SPAS).....	158
7.3.3.1.2	DFC Precedence Constraints (DFCPR).....	161
7.3.3.2	Assembly Sequence Evaluation (EDIT).....	161
7.3.4	<i>Control System Analyzer</i>	162
7.3.4.1	Type-1 tolerance analysis module (TYPE1.tol).....	163
7.3.4.2	Type-2 tolerance analysis module (TYPE2.tol).....	164
7.3.4.3	Optimal Controller design module.....	164
7.4	DESIGN SESSION.....	166
7.5	DISTRIBUTED DESIGN ENVIRONMENT.....	168
7.6	SUMMARY.....	170
8.	CONCLUSIONS.....	171
8.1	OVERVIEW.....	171

8.2	SUMMARY OF THE THESIS	171
8.3	MAJOR CONTRIBUTIONS	172
8.3.1	<i>Datum Flow Chain</i>	173
8.3.2	<i>Types of Assemblies</i>	173
8.3.3	<i>State Transition Models</i>	174
8.4	RECOMMENDATIONS FOR FUTURE WORK	175
8.4.1	<i>Extension to Compliant Parts</i>	175
8.4.2	<i>Multiple KC chains</i>	175
8.4.3	<i>Design of Measurement Plans</i>	176
8.4.4	<i>Automated design of optimal assembly features</i>	176
8.4.5	<i>Integration of software tools</i>	177
BIBLIOGRAPHY		179

List of Figures

FIGURE 1-1: EXAMPLES OF FIT-UP REQUIREMENTS THAT NEED TO BE SATISFIED DURING FINAL ASSEMBLY.....	20
FIGURE 1-2: A CAUSE-EFFECT DIAGRAM FOR FIT-UP PROBLEMS DURING ASSEMBLY.....	21
FIGURE 3-1: EXAMPLE TYPE-1 ASSEMBLY: ELECTROMECHANICAL PRESSURE RECORDER ASSEMBLY (KALPAKJIAN 1995).....	40
FIGURE 3-2: ILLUSTRATION OF ASSEMBLABILITY PROBLEMS IN TYPE-1 ASSEMBLIES (A) PLANNED SEQUENCE THAT FAILED (B) ALTERNATE ASSEMBLY SEQUENCE.....	41
FIGURE 3-3: DFCs FOR INSERTING PART D IN THE TWO ASSEMBLY SEQUENCES OF FIGURE 3-2.....	42
FIGURE 3-4: EXAMPLE TYPE-2 ASSEMBLY: (A) AUTOMOBILE FRONT END ASSEMBLY (B) SIMPLIFIED REPRESENTATION OF THE ASSEMBLY IN (A) (CHANG 1996).....	43
FIGURE 3-5: SOME SIMPLE ASSEMBLY FEATURES ILLUSTRATING SELECTIVE ABSORPTION OF VARIATION ALONG THE ARROWS.....	43
FIGURE 3-6: KC DELIVERABILITY ISSUES FOR TYPE-2 ASSEMBLIES: COMPARISON OF TWO ALTERNATE ASSEMBLY SEQUENCES FOR THREE SHEET METAL PARTS.	44
FIGURE 3-7: POSSIBLE DFCs FOR THE TWO SEQUENCES IN FIGURE 3-6.....	45
FIGURE 3-8: SCHEMATIC REPRESENTATION OF AN AIRPLANE WING SKIN ASSEMBLY. LEFT: THE PARTS. RIGHT: THE ASSEMBLY. THE SPLICE STRINGER IS A STIFFENER WIDE ENOUGH TO JOIN THE TWO SKIN PIECES. SUCH ASSEMBLIES CONTAIN MANY OTHER STRINGERS PARALLEL TO THE SPLICE STRINGER, BUT THEY ARE NOT SHOWN HERE.	47
FIGURE 3-9: A FLOWCHART FOR THE ASSEMBLY ORIENTED DESIGN SYSTEM	51
FIGURE 4-1: EXAMPLE ASSEMBLY (AIRPLANE HORIZONTAL STABILIZER UPPER SKIN ASSEMBLY)	56
FIGURE 4-2: (A) LIAISON DIAGRAM AND (B) DATUM FLOW CHAIN FOR THE ASSEMBLY IN FIGURE 4-1	56
FIGURE 4-3: HORIZONTAL STABILIZER POSITION ON THE AIRCRAFT.	59
FIGURE 4-4: HORIZONTAL STABILIZER TOP VIEW.	59
FIGURE 4-5: THE HORIZONTAL STABILIZER ASSEMBLY SHOWN IN EXPLODED VIEW	60
FIGURE 4-6: (A) UPPER SKIN ASSEMBLY FROM LOWER VIEW (B) IN-BOARD CROSS-SECTION VIEW OF THE UPPER SKIN ASSEMBLY AND PLUS CHORD	61
FIGURE 4-7: PRODUCT DECOMPOSITION AND RESULTING KCs.	62
FIGURE 4-8: KCs FOR THE HORIZONTAL STABILIZER UPPER SKIN ASSEMBLY	63
FIGURE 4-9: DESIRED DFC FOR DELIVERING THE KCs FOR THE ASSEMBLY.....	64
FIGURE 4-10: A DESIRABLE BUT IMPOSSIBLE SEQUENCE FOR THE HORIZONTAL STABILIZER ASSEMBLY	65
FIGURE 4-11: MODIFIED DFC THAT WAS ACTUALLY IMPLEMENTED DUE TO ASSEMBLY CONSTRAINTS.....	66
FIGURE 4-12: RESULTING FEASIBLE BUT UNDESIRABLE ASSEMBLY SEQUENCE THAT WAS ACTUALLY IMPLEMENTED..	67
FIGURE 4-13: (A) A DFC FOR THE ASSEMBLY IN FIGURE 4-1 (B) A POSSIBLE FEATURE SET IMPLEMENTATION TO CARRY THE DATUM LOGIC DEFINED BY THE DFC IN (A)	68
FIGURE 4-14: A CANDIDATE DFC FOR THE UPPER SKIN ASSEMBLY SHOWING MATES AND CONTACTS.....	70
FIGURE 4-15: A CANDIDATE DFC FOR THE UPPER SKIN ASSEMBLY SHOWING NUMBER OF DEGREES OF FREEDOM CONSTRAINED BY THE MATES. CONTACTS SHOWN AS DASHED LINES	71
FIGURE 4-16: INCOMPLETELY CONSTRAINED SUBASSEMBLIES NOT PERMITTED BY THE CONSTRAINT RULE FOR THE DFC IN FIGURE 4-15.....	72
FIGURE 4-17: FULLY DEFINED SUBASSEMBLIES FOR THE UPPER SKIN ASSEMBLY PERMITTED BY THE CONSTRAINT RULE FOR THE DFC IN FIGURE 4-15	72
FIGURE 4-18: (A) COMPLETE SET OF ASSEMBLY SEQUENCES (B) RESULTING FAMILY OF SEQUENCES AFTER APPLYING CONSTRAINTS IMPOSED BY THE DFC	74
FIGURE 4-19: MODELING MULTIPLE ASSEMBLY STATION ASSEMBLY PROCESSES USING DFC.....	75
FIGURE 4-20: DIFFERENT TYPES OF VARIATION PROPAGATION PROBLEMS IN ASSEMBLIES (THE DOUBLE-HEADED ARROW IN EACH ILLUSTRATION IS THE DFC).....	80
FIGURE 4-21: (A) LIAISON DIAGRAM SHOWING MULTIPLE LOOPS IN THE ASSEMBLY (B) DFC FOR THE ASSEMBLY; ALL CONTACTS ARE SHOWN AS DASHED LINES.....	83
FIGURE 4-22: CROSS-SECTION OF AN AIRPLANE FUSELAGE SECTION SHOWING THE KEEL PANEL SUB-ASSEMBLY	86
FIGURE 4-23: IMPORTANT DATUMS ON THE KEEL PANEL.....	87
FIGURE 4-24: DATUM FLOW CHAINS FOR THE KEEL PANEL ASSEMBLY.....	88
FIGURE 4-24(CONTINUED): DATUM FLOW CHAINS FOR THE KEEL PANEL ASSEMBLY.....	89

FIGURE 5-1: EXAMPLE BUILD UP OF PARTS UNDER INFLUENCE OF VARIATION. THE SHADED LINES INDICATE NOMINAL AND SOLID LINES INDICATE TRUE LOCATION OF THE PARTS. THE DEVIATION OF THE COORDINATE FRAME ON A MATING FEATURE ON THE KTH PART FROM NOMINAL LOCATION EXPRESSED IN BASE COORDINATE FRAME IS THE STATE OF THE SYSTEM $\tilde{X}(k)$	96
FIGURE 5-2: STATE TRANSITION MODEL OF A TYPE-1 ASSEMBLY	100
FIGURE 5-3: (A) A SIMPLE SLIP PLANE TYPE CONTACT FEATURE (B) VARIATION ABSORPTION ZONE AND (C) ITS CORRESPONDING \tilde{U} VECTOR	103
FIGURE 5-4: STATE TRANSITION MODEL FOR TYPE-2 ASSEMBLIES AT ASSEMBLY STATIONS WHERE CONTACTS ARE ESTABLISHED AND ADJUSTMENT IS POSSIBLE	104
FIGURE 6-1: A DISCRETE MULTI STAGE SYSTEM REPRESENTING A TYPE-1 ASSEMBLY PROCESS	109
FIGURE 6-2: BLOCK DIAGRAM REPRESENTATION OF TYPE-1 ASSEMBLY OPERATION DESCRIBED AS A GAUSS MARKOV SEQUENCE DRIVEN BY WHITE NOISE	109
FIGURE 6-3: EVOLUTION OF PROBABILITY DENSITY OF A STATE VARIABLE IN TYPE-1 ASSEMBLIES AFTER K ASSEMBLY OPERATIONS	111
FIGURE 6-4: EXAMPLE ASSEMBLY SHOWING INDIVIDUAL PARTS AND THEIR TOLERANCE ASSIGNMENTS (GILBERT 1992)	112
FIGURE 6-5: (A) PLANNED ASSEMBLY SEQUENCE (B) CONTROLLING DFC (C) RESULT OF VARIATION PROPAGATION ANALYSIS; ASSEMBLY IS PREDICTED TO FAIL 4% OF THE TIME	113
FIGURE 6-6: (A) ASSEMBLY SEQUENCE RESULTING FROM AN IMPROVED DFC EMPLOYING TWO FIXTURES (B) THE IMPROVED DFC (C) ASSEMBLY IS PREDICTED TO FAIL ONLY 0.001% OF THE TIME	114
FIGURE 6-7: A DISCRETE MULTI STAGE SYSTEM REPRESENTING A TYPE-2 ASSEMBLY PROCESS	115
FIGURE 6-8: (A) PDF BEFORE TUNING. SHOWN SHADED IS THE RANGE OF OUTPUT THAT CAN BE TUNED OUT (B) RESULTING PROB. DENSITY FUNCTION AFTER TUNING	116
FIGURE 6-9: PROBABILITY DENSITY FUNCTIONS FOR VARIABLE X BEFORE MAKING ADJUSTMENTS, AFTER MAKING ADJUSTMENTS AND AFTER APPROXIMATION BY A EQUIVALENT NORMAL DISTRIBUTION	118
FIGURE 6-10: VARIATION ABSORPTION METHODOLOGY FOR TYPE-2 ASSEMBLIES	119
FIGURE 6-11: A TYPE-2 EXAMPLE CONSISTING OF THREE SHEET METAL PARTS	121
FIGURE 6-12: VARIATION PROPAGATION ANALYSIS IN THE PRESENCE OF ADJUSTMENTS USING STATE TRANSITION MODELS: ASSEMBLY SEQUENCE #1	122
FIGURE 6-13: VARIATION PROPAGATION ANALYSIS IN THE PRESENCE OF ADJUSTMENTS USING STATE TRANSITION MODELS: ASSEMBLY SEQUENCE #2	123
FIGURE 6-14: BLOCK DIAGRAM REPRESENTATION OF A TYPE-2 ASSEMBLY PROCESS CONTROLLED BY STOCHASTIC OPTIMAL CONTROLLER	131
FIGURE 6-15: (A) AUTOMOBILE FRONT-END ASSEMBLY (B) SIMPLIFIED REPRESENTATION OF THE ASSEMBLY IN (A) (CHANG 1996)	134
FIGURE 6-16: (A) ASSEMBLY OF THE FENDER-RADIATOR SUBASSEMBLY TO THE MAIN BODY FRAME (B) FIGURE SHOWING THAT RESULTING X VARIATION ASSOCIATED WITH FRAME 4 IS OF NO CONCERN	136
FIGURE 6-17: A SCHEMATIC SHOWING THE COORDINATE FRAME LOCATIONS ON THE DIFFERENT PARTS OF THE ASSEMBLY	138
FIGURE 6-18: DESCRIPTION OF CONTROL ACTIVITY AT THE KTH ASSEMBLY OPERATION	139
FIGURE 6-19: MODELING THE ACTIVITIES AT THE 0TH ASSEMBLY OPERATION	140
FIGURE 6-20: A SCHEMATIC SHOWING THE COORDINATE FRAME LOCATIONS ON LHIF AFTER 1 ST ASSEMBLY OPERATION	141
FIGURE 6-21: MODELING THE ACTIVITIES AT THE 1ST ASSEMBLY OPERATION	141
FIGURE 6-22: MODELING THE ACTIVITIES AT THE 2ND ASSEMBLY OPERATION	143
FIGURE 6-23: A SCHEMATIC SHOWING THE COORDINATE FRAME LOCATIONS ON THE DIFFERENT PARTS OF THE ASSEMBLY	145
FIGURE 6-24: MODELING THE ACTIVITIES AT THE 3RD ASSEMBLY OPERATION	146
FIGURE 6-25: A POSSIBLE CONTACT FEATURE DESIGN RESULTING FROM OPTIMAL CONTROL	148
FIGURE 6-26: A POSSIBLE CONTACT FEATURE DESIGN RESULTING FROM OPTIMAL CONTROL FOR 1 DOF SYSTEM	150
FIGURE 7-1: A FLOWCHART OF THE ASSEMBLY ORIENTED DESIGN SYSTEM	154
FIGURE 7-2: THE INTERACTIVE DFC EDITOR	156
FIGURE 7-3: GRAPHICAL USER INTERFACE OF THE MLA SOFTWARE	158
FIGURE 7-4: GRAPHICAL USER INTERFACE OF THE SPAS SOFTWARE FOR GENERATING GEOMETRIC ASSEMBLY PRECEDENCE CONSTRAINTS	160

FIGURE 7-5: AN INTERACTIVE SESSION WITH THE EDIT SOFTWARE FOR EVALUATING ASSEMBLY SEQUENCES 162
FIGURE 7-6: GRAPHICAL USER INTERFACE OF THE INPUT WINDOW THAT INTERACTIVELY TAKES INFORMATION FOR EVERY COORDINATE FRAME AND PROVIDES IT TO TYPE1.TOL 163
FIGURE 7-7: EXAMPLE INTERACTIVE SESSION WITH THE CONTROL THEORY ANALYZER..... 165
FIGURE 7-8: ASSEMBLY MODFLING SERVICES IN A DISTRIBUTED WEB BASED ENVIRONMENT 169

List of Tables

TABLE 4-1: DESIGN RULES IMPOSED BY THE DFC THAT CAN BE USED TO VERIFY DESIGNS	77
TABLE 6-1: UNCERTAINTIES ASSOCIATED WITH THE AUTOMOBILE FRONT END SUBASSEMBLIES.....	134

The world is full of magical things patiently waiting for our wits to grow sharper

-- Bertrand Russel

1.

Introduction

1.1 Motivation and Goals

Most complex assemblies consist of many individual sub-assemblies and parts that are made by different suppliers at different locations. Assembly is the point in the product cycle where parts from disparate sources come together and the product first comes to life. Fit-up¹ problems are often discovered during final assembly when trying to put these parts and sub-assemblies together. Classes of problems where the parts or subassemblies do not fit during assembly or final assembly requirements are out of specification are called as fit-up problems. Two such cases of assembly fit-up problems are illustrated in Figure 1-1. For the assembly shown in Figure 1-1 (a), when the two sections of the fuselage are assembled, the circumference on the two sides need to match, the passenger and cargo floors need to line up, and the stringers on the skins on both sides need to align, among other things. A number of design requirements (also called key characteristics) shown in Figure 1-1 (a), need to be satisfied upon final assembly. Typically due to accumulated variation from numerous sources, it may not ways be possible to simultaneously satisfy all these requirements. Similarly, for the assembly shown in Figure 1-1 (b) upon final

assembly, the margins and flushness values between the front fenders and the hood have to be within acceptable values. Finding the source of these fit-up problems is a very difficult and time-consuming task, and most of the time the exact causes cannot be identified. The time and cost involved to make engineering changes, in-production adjustments, etc. to fix these problems increase rapidly as the product development process evolves. Early anticipation and avoidance of these problems can have a huge impact in reducing the product development time, cost, and production fit-up problems, and can improve final product quality.

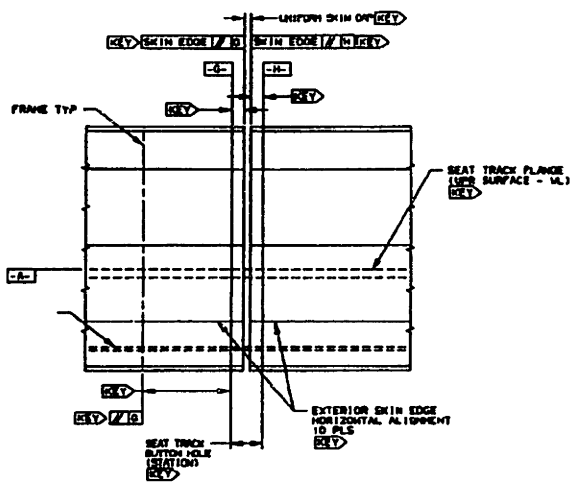

(a) Boeing 777 fuselage joint

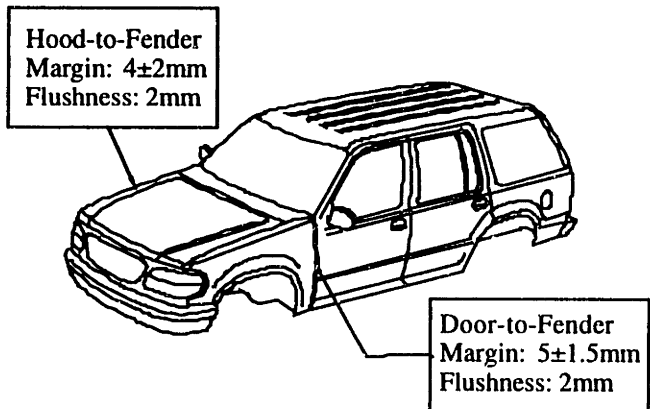

(b) Ford Explorer front end assembly

Figure 1-1: Examples of fit-up requirements that need to be satisfied during final assembly

Some of the important sources of these fit-up problems are as follows:

- incorrect design
- incorrect assembly procedures or equipment
- improper part fabrication

If we attempt to represent this on a cause-effect Ishikawa diagram, it would look something like this:

¹ Fit-up is a term commonly used in the automotive industry for assembly problems

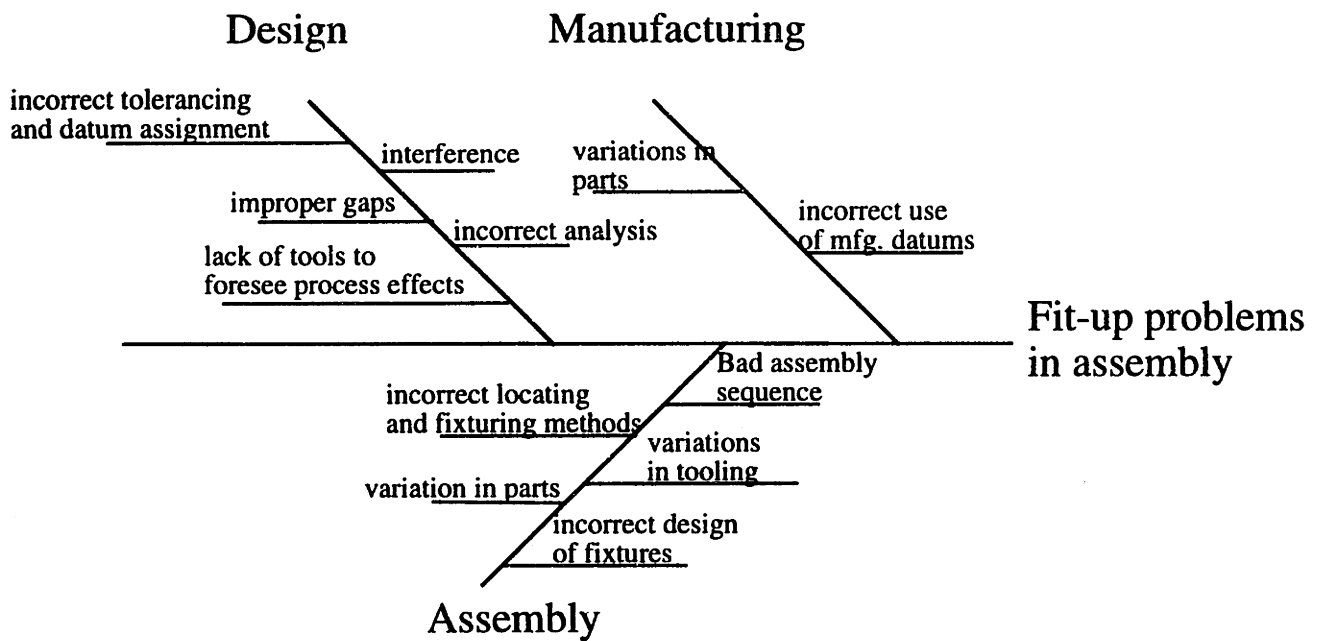

Figure 1-2: A cause-effect diagram for fit-up problems during assembly

The scope of this thesis is limited to the following two problem areas:

Problems in design

One of the most common causes of fit-up problems is incorrect design of parts and assemblies. Most often this happens because of the part-centric view of existing CAD and design tools. These tools do not enable the designer to foresee downstream process issues during design. Incorrect design could take several forms:

Inconsistent dimensional and relational logic: Due to the bottom up nature of existing design tools, relations between different parts in the assembly are not represented until all individual parts are designed completely. The choice of datums and dimensional scheme used to construct the individual parts hence may not be consistent with the design requirements of the assembly. It is a common tendency to build the model using dimensional relations that are most convenient to construct the model on the computer. These relations may have no relation with the ones that actually need to be controlled during assembly to deliver the product requirements. Tolerancing & datum assignment and choice of assembly procedures

are very closely related. Sometimes incorrect assembly procedures applied on perfect components can lead to fit-up problems.

Incorrect analyses: Most CAD systems represent only final part geometry and final nominal assembly configurations. As a result most analyses such as tolerance stackup are performed on final assembly configurations, and the act of “assembling” is ignored. Also there is a tendency to apply the same modeling techniques to all kinds of assemblies. As will be described later in this thesis, there are some fundamentally different types of assemblies and the differences between them need to be understood to predict and analyze fit-up problems.

Problems in assembly

Another common cause of fit-up problems is the employment of incorrect assembly techniques and procedures, even though the parts are correctly designed and manufactured. Most often these occur due to the inability of the current design tools and assembly models to capture and convey assembly process related information to processes, people, suppliers, etc. Assembly is often the first point where part variation caused by design errors and oversights ultimately surfaces. The broad class of alignment errors suggests potential product design improvements. While many manufacturers, with the assistance of various tools, are able to eliminate errors in the nominal design, managing variation is a distinct challenge. In the worst case, as components are assembled, variation in the parts reduces mass produced assemblies to mass customized assemblies. Problems during assembly can occur due to the following:

Incorrect assembly sequence

The sequence chosen to assemble the components is often not consistent with the design of the components and the assembly at large. This results in the assembly process not controlling the critical interfaces during assembly due to information gaps between design and assembly.

Incorrect locating and fixturing methods

Again due to information gaps, parts are often located incorrectly by referencing to wrong datums during assembly. This occurs because most assembly modeling techniques do not include fixtures in their analyses.

Variations in the fixtures and incoming components

1.2 Problem Statement

The goal of this thesis is to define a conceptual framework for an “*assembly centric*” approach to design and focus on:

a better understanding of how to model assemblies during the early stages of design and relate design requirements with choice of assembly procedures

a better understanding of the assembly process so that such problems can be anticipated and avoided

developing algorithms and computational tools to quantify the effects of choosing different assembly procedures on the quality of the final assembly

This research will increase our understanding of how to model mechanical assemblies for the purpose of analyzing them very early in the product design cycle. New computer aids for the design process will be possible, and more designers will have access to knowledge and techniques.

1.3 Organization of Thesis

This thesis presents an integrated framework that CAD tools can employ to design assemblies and assembly processes at a conceptual stage of design. The approach consists of modeling non-ideal parts and their associated assembly processes.

Chapter 2 reviews past research work relevant to this thesis. Past work is classified into two broad categories: Assembly modeling and design, and Modeling variation propagation in assemblies. It provides a background on existing work

Chapter 3 presents the assembly oriented design framework for top down design of assemblies. It identifies the need for new modeling techniques to address problems that current CAD and assembly modeling approaches are not capable of handling. Two types of assemblies, and their associated assembly problems, are identified and presented using examples. The chapter summarizes the scope of the assembly oriented design approach and presents the needs that are addressed by the techniques presented in forthcoming chapters.

Chapter 4 presents the Datum Flow Chain technique to model and design assemblies. The concept of the DFC, its properties, scope and role in assembly planning are described in this chapter. An example from the aircraft industry is used to illustrate the scope of the DFC in assembly design. The chapter also presents several analysis techniques to evaluate and compare alternate DFCs. It identifies four classes of variation propagation problems that need to be addressed to evaluate and compare DFCs.

A common framework to model and analyze the four types of variation propagation problems is presented in Chapter 5. State transition models are developed to model variation propagation and control. The assembly process is modeled as a discrete event linear time varying system. A modeling environment is created that can exploit concepts from control theory to predict and control variation in assembly processes.

Chapter 6 describes the use of the state transition modeling approach introduced in chapter 5, to study variation propagation and control in the two types of assemblies introduced in Chapter 3. Algorithms are developed based on this approach to determine and control variation in final assembly propagated through the combined effect of individual part variations and choice of assembly procedures. Concepts from control theory are used to design assembly features between parts.

Chapter 7 describes some of the software tools developed to implement the techniques introduced in the previous chapters.

Chapter 8 summarizes the contributions made by the thesis and presents directions for future work.

“ Men's thoughts are much according to their inclination, their discourse and speeches according to their learning and infused opinions.”

- Francis Bacon

“ Discovery is seeing what everyone else has seen and thinking what no one else has thought. ”

- Albert Szent-Gyorgi

2.

Related work

2.1 Overview

The purpose of this chapter is to present the background information relevant to the research described in the remainder of this thesis. The research focus of this dissertation overlaps various areas. Previous work related to this work can be classified into two broad areas: assembly modeling and design, and modeling variation propagation in assemblies. A historical overview as well as current research in the area is presented.

2.2 Assembly Modeling and Design

Assembly modeling involves the consideration of a number of design activities. Research in assembly modeling can be classified into the following categories: These include:

Computer representation and analysis of assemblies

Generation and consideration of assembly sequences

Integration of the different design functions

2.2.1 Assembly representation and analysis

Computer aided design (CAD) support for the design process can be introduced using either a top-down or a bottom-up approach. In top-down design environments, the designer first generates a functional representation of the design. This representation can be in the form of a system of constraint equations, or an implicit design representation that corresponds to some functionality. In bottom-up design environments on the other hand, the designer develops a mental model of the design and then models it by first constructing all the individual parts and then putting them together to construct assemblies. Current CAD systems provide rudimentary assembly modeling capabilities once parts are modeled. These are primarily geometric modeling techniques that simulate an assembly drawing and can share geometry centered information between CAD and CAM-oriented activities, Gui and Mäntylä (Gui, et al. 1994).

Current CAD systems rely on a bottom-up component level approach by providing a set of modeling tools for component design. Assembly relations are then defined between completely designed components. Some CAD systems such as Pro/Engineer, provide a feature-based environment to the designer to construct the designs. Each feature contains some attributes - a necessary set of parameters to define the feature. What "*feature*" means is quite different from different points of view. With respect to geometric modeling, in (Shah 1991), "features are generic shapes with which the engineers associate certain properties or attributes and knowledge useful in reasoning about the product". However, the features used in most environments are essentially features derived from manufacturing domains (Cunningham, et al. 1988). Another definition of features in the context of object oriented programming from (Gui 1993) is, features are "objects that may contain method for manufacturing, analysis geometry creation, assembly; or pointers to geometry, geometric constraints, or inherited properties". Several other authors also differentiate between design or functional features, manufacturing features, and geometric features (Mäntylä 1990). Most representation of assemblies in the bottom-up approach involves defining the solid models of individual components and positioning them in space. A solid modeling system called NONAME (1981), developed at Leeds represents the assemblies as a list of components defined in a CSG language together with translations and rotations relative to the

system's global coordinate system which positions them in the assembly. More recently, considerable work has been done in feature based design, but it focused mostly on the ease of part geometry creation and information for evaluating individual part fabrication, especially machining. DeFazio et al (DeFazio, et al. 1990) present a feature based design environment aimed at the design of assemblies of parts. They present feature based design as a technique to capture design intent and think beyond mere shape and to state explicitly what portions of a part are important and why.

Several researchers have worked on top-down design of assemblies. Popplestone (Popplestone 1987) provides a top down design support using modules. Each module corresponds to a particular functionality, and this function is described by mathematical constraints internal to the module. The designer specifies constraints between modules. Mäntylä (Mäntylä 1990) describes a system that can represent assembly information at different levels of abstraction, represent design intent by preserving an entity's function, and record the level of commitment to an aspect of the design. An interesting feature of the system developed is its capability of supporting alternative breakdowns of a design into design features and relations by means of views while maintaining consistency and inherited features. Mäntylä's analysis and summary of the information requirements are echoed by Sodhi and Turner (Sodhi, et al. 1992). Gui (Gui 1993) extends this approach and attempts to construct an assembly browser in an object oriented design environment. The major concept is based on a multi-graph data structure considering components and connectors. A component mainly performs the required functions to meet the structural or kinematic requirements. On different levels a connector performs coupling, supporting or other constraint functions to make the components mate.

A number of researchers have worked on constructing assembly models with the goal to perform a one type of analysis or another. Most researchers have used graph structures to model assembly topology. Bourjault used a liaison diagram graph structure to represent the assembly. A node in the graph represents a part and an arc represents a joint between two parts. Lee and Gossard (Lee, et al. 1985) developed a system that supports a hierarchical assembly data structure containing more basic information about assemblies such as "mating features" between components. The transformation matrices are derived directly from the associations of the virtual

links. Andrews developed methods for inferring transformation matrices directly from mating conditions (Lee, et al. 1985). Assemblies have also been modeled by (Srikanth, et al. 1991), Rocheleau and Lee (Rocheleau, et al. 1987), Gui and Mäntylä [(Gui 1993); (Gui, et al. 1994); (Mäntylä 1990)], and Roy et al (Roy, et al. 1989) among others. Most of these assembly representations and methods were intended to capture relative part location and function, and enable linkage of design to functional analysis methods like kinematics, dynamics, stress, and vibration, and in one case, tolerances. Some representations were used to generate assembly sequences. Some research focuses on part geometry and creates assemblies by linking part surfaces or other constraints.

2.2.2 Assembly sequence consideration

Choice of assembly sequence affects so many aspects of product design and process layout design that consideration and evaluation of candidate assembly sequences is an essential element of design activity. Assembly sequence studies require identification of sub-assemblies, clearances and tolerances, potential jiggling and gripping surfaces, grip and assembly forces, factory layout, and a number of other issues that must be accounted for during early stages of product design.

A number of researchers have worked on developing techniques to generate assembly sequences (DeFazio, et al. 1987), Homem de Mello and Sanderson (Mello, et al. 1989), Ko and Lee (Ko, et al. 1987), Wilson (Wilson 1994) for the assembly starting from the descriptions of the parts constituting the assembly. While some have tried to generate all possible sequences, others have tried to identify a single optimal sequence subject to certain constraints. Some methods use user-input to infer geometric relations between parts, while others have tried to generate this information directly from a CAD database.

(Baldwin, et al. 1991) developed an integrated computer aid to evaluate different assembly sequences based on different criteria such as desirability of sub-assemblies, number of fixtures involved, number of re-orientations, stability of sub-assemblies, etc. (Romney, et al. 1995) proposed a software system that can automatically determine how to assemble a product from its parts, given only a geometric description of the assembly.

In most of these approaches assembly sequence is used as a line-balancing tool and has been considered after all the parts have been designed. There has not been much effort to identify assembly sequences at a concept stage where the geometry of the parts is not certain yet and use them to influence the design of the assembly.

2.2.3 Integrated computer tools

Some researchers have also worked on developing an integrated approach to assembly design. (Hsu, et al. 1993) describe an integrated design-planning system to redesign assemblies based on feedback evaluation of a given assembly plan. The product is redesigned using assembly criteria such as minimizing assembly time, reducing the number of redundant operations and achieving better assemblability. Huang and Lee (Huang, et al. 1991) describe a knowledge-based system to automatically generate assembly plans from a CAD model using predicate calculus and heuristics. Eversheim and Baumann (Eversheim, et al. 1991) describe a system called DEMOS to allow assembly-specific optimization of the product structure and part geometry. A commercial solid modeler (EUCLID[®] from MATRA Datasystems) and a commercial data management system have been combined with a rule and database and user interface to create this system. DEMOS is an effort to create an environment where decisions can be made without geometry. DeFazio et al (DeFazio, et al. 1990) propose a prototype integrated computer environment whose contributions comprise: integration of feature based design with several existing and new assembly analysis and synthesis algorithms; construction of feature properties to meet the needs of those algorithms; a carefully chosen division of labor between the designer and computer and illustration of feature-based models of products as the information source for assembly analysis and process design. Several of these functions were implemented as prototype software to highlight the benefits to be expected from a fully functional system.

Most of these systems are based on the bottom-up approach and need full description of parts before they can be used. In addition there is a tendency to model final configurations of assemblies without the consideration of intermediate stages of assembly.

2.2.4 Discussion

In this thesis, we are interested in developing computer aids to design assemblies and assembly processes to repeatedly deliver a set of assembly requirements. We are interested in the conceptual stage of design and attempt to develop tools that will enable a number of criteria to be considered without knowledge of detailed geometry. We wish to postpone commitment to geometry as long as possible and focus on the underlying logic of dimensional datum relationships. With the exception of classical methods used in kinematic analysis, most research on assembly representation includes geometry of parts as a major element.

Top-down design emphasizes the shift in focus from managing individual part design to managing the design in terms of mechanical “interfaces” between parts. More recent work attempts to adopt this approach. Smith (Hart-Smith 1997) proposes eliminating or at least minimizing critical interfaces in the structural assembly as opposed to part-count reduction as a means of reducing costs. The process of interface control is also known as dimensional management. He emphasizes that at every location in the assembly structure, there should only be one controlling element that defines location and everything else should be designed to drape to fit. This is similar to the idea of mates and contacts introduced by Mantripragada et al (Mantripragada, et al. 1996). Muske (Muske 1997) describes the application of dimensional management techniques on 747 fuselage sections. He describes a top-down design methodology to systematically translate key characteristics to critical features on parts and choice of assembly and fabrication methods. No computer or conceptual tools to support these processes are described.

We are interested in relating design of dimensional plans for parts and assemblies, to design requirements, choice of assembly procedures and sub-assembly design. For this purpose, we need to describe and evaluate the tolerances of incomplete assemblies, assemblies mounted in fixtures, and assemblies linked at least temporarily by incomplete constraints, none of which are addressed by past research. We need to be able to design dimensional and tolerance relationships between parts first and then commit to geometry.

In addition, based on our study of complex assemblies, we feel that the current assembly modeling tools are incapable of modeling different types of assembly problems. Most assembly modeling techniques in the past have tried to employ the same techniques to all assemblies and have not tried to make the distinction between some fundamentally different types of assemblies. As a result there are some assembly problems that cannot be explained by existing modeling techniques. There is a need to understand the physics of the assembly process first and then develop assembly models that carefully represent them.

2.3 Variation propagation analysis in assemblies

The second area of interest to this thesis is modeling variation propagation in assemblies. Modeling variation in mechanical assemblies has been a subject of intense research and has received attention by a wide spectrum of researchers. The work can be summarized into two main categories: Tolerance analysis, and Tolerancing and assembly process.

2.3.1 Tolerance analysis

The goal of tolerance analysis has been to estimate the variation in assembly parameters arising from the naturally occurring variations in part dimensions and features. The approach has been to construct a geometric (CAD) model of the assembly to which the variational analysis is applied. Tolerance analysis can be done in three basic ways: worst-case, statistical and Monte Carlo. A detailed description of these techniques can be found in (Chase, et al. 1991). Fortini (Fortini 1967) and BJORKE (BJORKE 1989) provide an extensive discussion of tolerance analysis. Comparison of several commercial tolerance analysis packages can be found in (Turner 1993) (Turner 1990). The goodness of a tolerance analysis depends on (1) accurate estimation of component variations (2) accuracy of the assembly model used to model the assembly process and (3) mathematical techniques used to add two or more variables with certain distributions. Currently, most literature emphasizes the third.

2.3.2 Tolerancing and assembly process

Most tolerance analysis work developed so far concentrates on the final assembly configuration and ignores completely the “**act of assembling**”. Gilbert first addressed this issue and used tolerance analysis to predict the success of an assembly operation by representing tolerances as 4x4 transforms (Whitney, et al. 1994). Through a closed form error propagation algorithm,

tolerances so represented are analyzed in three dimensions. This method was used to evaluate the success or failure of assembly operations. This work was extended by Moro (Moro 1994), who evaluated two alternate dimensioning and tolerancing schemes for a particular design and assembly sequence. The work looked at how an experienced designer who incorporated assembly considerations during design could tolerance the parts (make datum assignments) more effectively than one who did not incorporate assembly considerations, without needlessly tightening the tolerances. Lee et al (Lee, et al. 1997) used this representation to evaluate assemblability of two subassemblies with respect to pose tolerance and clearance of mating features among parts. Sanderson (Sanderson 1997) proposed an assemblability measure based on Gaussian approximations to actual parts distributions and the use of maximum likelihood as a means to achieve analytical solutions. A Kalman filter type estimation is used to compute this maximum likelihood assembly configuration which is used to evaluate the deviation from nominal. Assemblability is defined by the maximum likelihood clearance from constraints.

It is a well-known fact that assembly sequence and mode of location of parts during assembly have a very profound effect on the assemblability or accuracy of the final assembly. A typical assembly can have several hundreds of assembly sequences making the consideration and evaluation of each one of them a very cumbersome and difficult task. Not much work has been done to devise techniques to quickly look at a number of assembly sequences and evaluate their tolerance implications at once.

Fixtures are another integral part of the assembly process and thus have to be included in any tolerance chain. Most work in the past has concentrated on either analysis of the assembly in the final configuration or one particular assembly operation. Hence fixtures have either been ignored or have been included to a limited extent in the analysis.

Discrete event systems have been used extensively to model such systems as manufacturing system design and robotic task planning where all the events occur at discrete instances in time. McCarragher (McCarragher 1996) modeled the assembly operation as a discrete event system for robotic task planning. The assembly process is broken down into its task primitives or fundamental states of contact, which are then used to generate process control algorithms. As

was first introduced in (Mantripragada, et al. 1997), we propose modeling the entire assembly sequence as a set of discrete events to study the propagation of variation in mechanical assemblies. The total variation associated with the assembly at any assembly station is used to define the state of the system.

There has not been much work in the area of modeling variation propagation in the presence of in-process adjustments during assembly. Tuning adjustments are quite common in manufacturing processes and have been modeled by Otto and Antonnson (Otto, et al. 1993), Soyucali and Otto (Soyucali, et al. 1997). Tuning variables are characterized by being set in response to noise variations after their effects have occurred, Otto (Otto 1994). Lee et al (Lee, et al. 1997) proposed a method to analyze assemblies in terms of assemblability based on tolerances and adjustability of parts. They propagate clearances through the assembly in a manner similar to propagating tolerances and define an adjustable zone for clearance between each set of parts to compensate the effect of variation. We introduce the idea in (Mantripragada, et al. 1997, Mantripragada, et al. 1997) that in certain types of assemblies, by carefully choosing a combination of datum logic, assembly features and assembly sequence, in-process adjustments during assembly can be made to tune out some of the variation contributed by individual piece parts. Mathematical formulations to describe variation propagation in the presence of adjustments are derived and will be presented in forthcoming chapters.

2.4 Summary

A description of the various assembly modeling techniques (particularly in the conceptual design phase) developed in the past was presented. Most research work has focused on two issues: capturing the physical relationships needed to build a functional model of the assembly, and capturing the geometric relationships between part locations in order to build a geometric model of the assembly. The focus of this thesis work is representing a different kind of relational information: one of representing dimensional logic to enable abstract representations of both complete assemblies and unfinished ones. This would enable the requirements of the final assembly to be taken into account when planning the assembly process, so that those requirements in turn can be reflected in specifications for individual parts. There exists little research literature in this area.

" We design parts. We do not design assemblies"

- Engineer at Ford

"... But the customer sees assemblies not parts"

- Daniel Whitney

3.

Assembly Oriented Design

3.1 Overview

Most assembly fit-up problems occur due to a part-centric approach to product design that ignores assembly and system issues. It is common to view assembly as a process that merely fastens parts together. The assembly process should be viewed as a proxy for a wide range of decisions, events, and relationships between different stages of the product development process. Assembly is really chaining together of dimensional relationships and constraints. The success of these chains determines the success of the product's quality from an assembly point of view. The goal of assembly modeling is to permit these chains to be defined first, and followed by design of individual parts. We propose a concept called the "Datum Flow Chain" (DFC) to implement this approach to assembly modeling.

Current CAD systems provide rudimentary assembly modeling capabilities once part geometry exists, but these capabilities basically simulate an assembly drawing. Most often the dimensional relations that are explicitly defined to build an assembly model in CAD are those most

convenient to construct the CAD model and are not necessarily the ones that need to be controlled for proper functioning of the assembly. What is missing is a way to represent and display the designer's strategy for locating the parts with respect to each other, which amounts to the underlying structure of dimensional references. The DFC is intended to capture this logic.

In this chapter we introduce a new approach to modeling and designing assemblies at a conceptual stage of design. In the proposed assembly oriented design approach, the design of a complex assembly starts by a general description of the top level design requirements (key characteristics, KCs) for the whole assembly. These requirements are then systematically formalized and flowed down to sub-assemblies and finally down to individual parts. During these early stages of design, the following major elements of the design process have to be considered:

Systematically relate the identified KCs to important datums on parts and fixtures at the various assembly levels

Design the dimensional and tolerance relationships (locating schemes) among elements of an assembly from these KC relationships

Identify assembly procedures that best deliver the KCs repeatedly without driving the costs too high.

Current CAD systems do not support this approach to designing assemblies and encourage premature definition of part geometry, allowing designers to skip the consideration of these elements. The proper consideration of these elements at an early stage of the design can avoid potential problems during final assembly. The authors in (Mantripragada, et al. 1996), introduced early results of this work. Most assembly modeling techniques in the past have tried to apply a single technique to model all assemblies and have not tried to make the distinction between some fundamentally different types of assemblies. As a result there are some assembly problems that cannot be explained by existing modeling techniques. We have identified two types of assemblies that require different modeling methods because they are assembled by totally different means. The following sections describe the two types of assemblies and their associated assembly problems.

3.2 Types of assemblies and assembly problems

Most models of assemblies represent the assembly as complete, i.e. with all its parts in place and all joints fastened. Therefore these models are not capable of addressing issues that occur during the act of assembling. Assembly planning involves considering a series of successively more complete assemblies. Incomplete assemblies may have unconstrained degrees of freedom that will be constrained when the assembly is complete. They may be subject to shape or size variations that the final assembly will not be subject to. Yet these uncontrolled degrees of freedom or variations may cause the next assembly step to fail or may result in a mishapen final assembly, and thus have to be considered during design. In order to manage these issues systematically, we distinguish two types of assemblies.

3.2.1 Type-1 assemblies

Type-1 comprises typical machined or molded parts that have their mating features fully defined by their respective fabrication process prior to final assembly. We also call these “*part-defined*” assemblies, because the variation in the final assembly is determined completely by the variation contributed by each part in the assembly. The assembly process merely fastens the parts together by joining their pre-defined mating features. The assembly process is thus passive and cannot influence the distribution of variation in the assembly. The mating features are almost always defined by the desired function of the assembly, and the assembly process by itself has no freedom in selecting mating features.

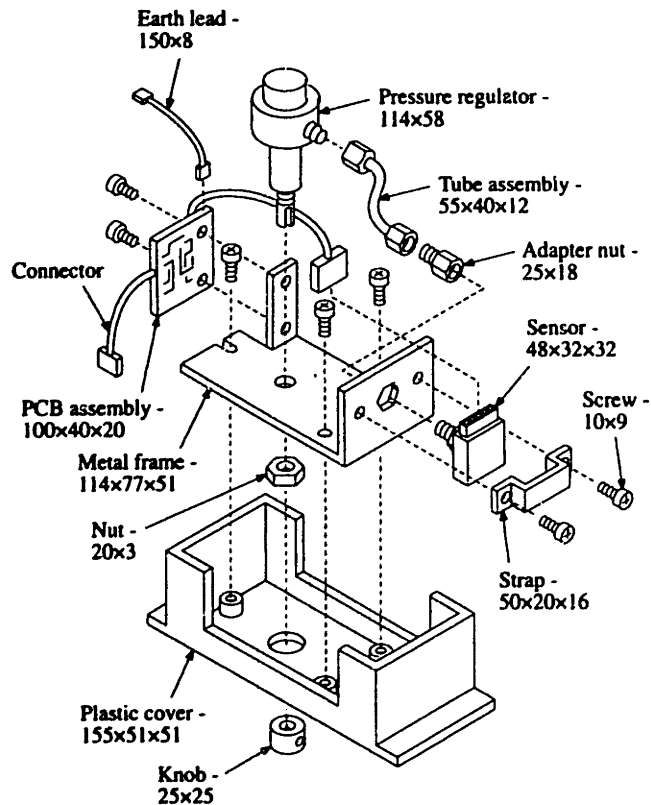

Figure 3-1: Example type-1 assembly: Electromechanical pressure recorder assembly (Kalpakjian 1995)

Figure 3-1 shows an exploded view of an example type-1 assembly. This assembly has several subassemblies and parts and they all come with fully designed mating features to the final assembly line. The assembly process, which could be either manual or automatic, involves joining these parts and subassemblies at their mating features. Fixtures if used, only provide support and do not define any dimensional relationship between the parts. The kinds of problems associated with the assembly of type-1 assemblies are termed assemblability problems and are defined in the next section.

3.2.1.1 Assemblability problems

These refer to a class of assembly problems where an intermediate assembly operation fails to assemble a part or subassembly. Such problems usually occur due to interference of parts caused by variation associated with parts and fixtures. Figure 3-2 shows a typical assembly of rigid parts. Its “natural” assembly sequence fails because part “B” was not tolerated for its role as a

base part for the sequence. An alternate successful sequence is shown in Figure 3-2(b). The planned sequence shown in Figure 3-2 (a), fixtures the assembly on the bottom of B. But in fact the B's bottom surface is not reliably perpendicular to the axis due to loose tolerances. As a result, part C tilts and part D could strike it during assembly. This is a real case, and redesign to improve part tolerances was not permitted. The only option was a new sequence shown in Figure 3-2 (b), which transfers the B-C subassembly to a new fixture which holds part C by the end that is better tolerated. This sequence worked because part B's angular error in fixture #2 is not large enough to prevent part C from mating to it.

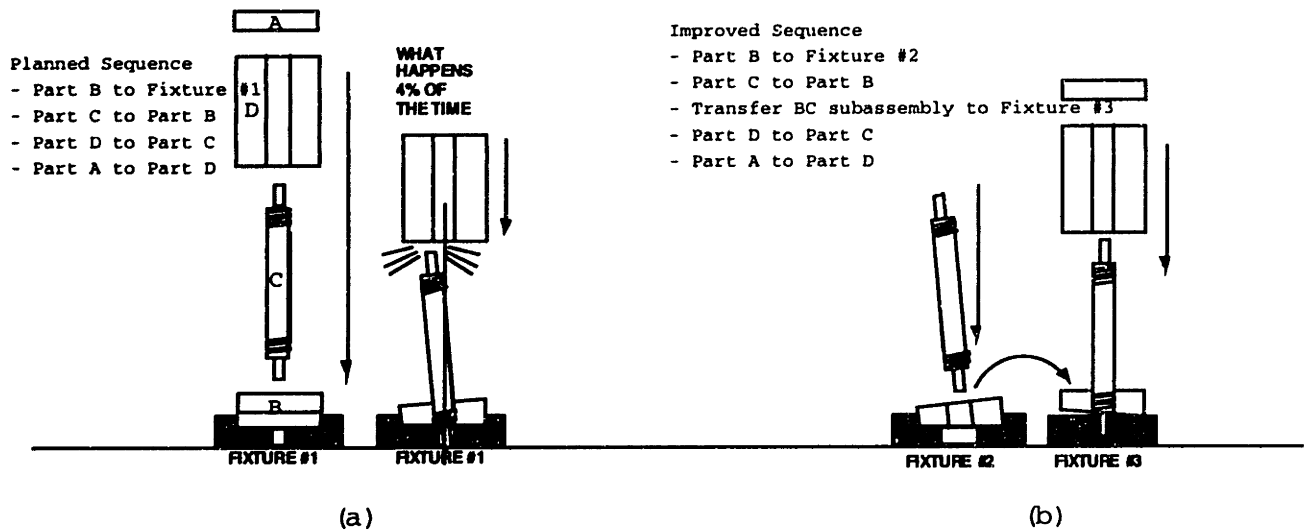
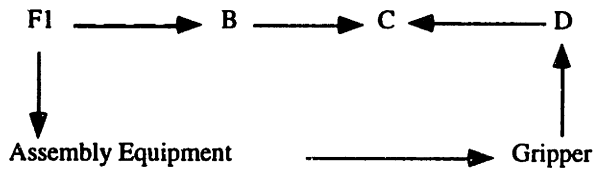

Figure 3-2: Illustration of assemblability problems in type-1 assemblies (a) planned sequence that failed (b) alternate assembly sequence.

Figure 3-3 seeks to capture the difference between the two sequences using DFCs. Each chain can be constructed without knowing detailed part shapes, and the problem with the first sequence can be found early in product design. Dashed arrows indicate mates with poor tolerances. The first chain should be read as follows: Fixture F1 provides dimensional reference for part B, which provides dimensional reference for part C. F1 also locates the assembly equipment and gripper which provides dimensional reference for part D. The failure of this chain is implied by the dashed arrow. The DFC for the improved sequence is in fact two distinct chains. The assembly equipment is shown only for the second of these chains. A more detailed description of the concept and properties of the DFC are given in chapter 4. This example is revisited in chapter 6 where a detailed analysis is performed.

Datum flow chain for inserting Part D in the planned sequence



Datum flow chain for inserting Part D in the improved sequence

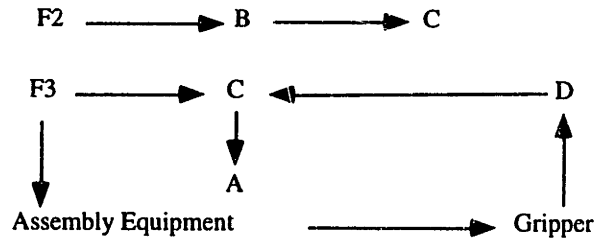

Figure 3-3: DFCs for Inserting part D in the Two Assembly Sequences of Figure 3-2.

3.2.2 Type-2 assemblies

The second type of assembly includes aircraft and automotive body parts that are usually given some or all of their assembly features or relative locations during the assembly process. Assembling these parts requires placing them in proximity and then drilling holes or bending regions of parts, as well as riveting or welding. The locating scheme for these parts must include careful consideration of the assembly process itself since function by no means is a sufficient guide. Final assembly quality depends crucially on achieving desired final relative locations of the parts, something that is by no means assured because at least some of the parts lack definite mating features that tie them together unambiguously. A different datum flow logic, assembly sequence, etc. will result in quite different assembly configurations, errors and quality. It is possible to build a perfect assembly out of imperfect parts and vice versa by choosing appropriate or inappropriate datum flow chain logic.

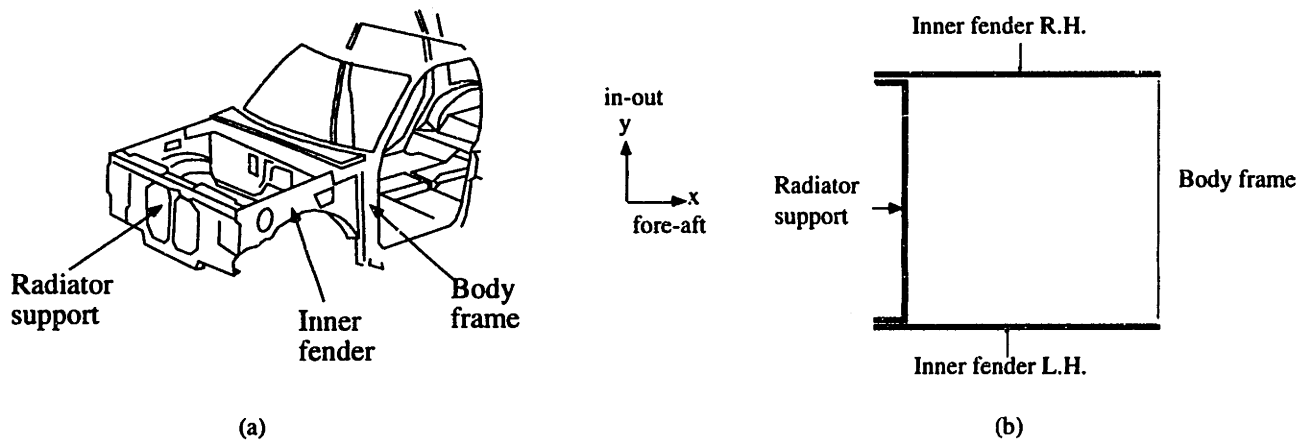

Figure 3-4: Example type-2 assembly: (a) Automobile front end assembly (b) Simplified representation of the assembly in (a) (Chang 1996)

An example type-2 assembly is shown in Figure 3-4. It is an automobile front-end assembly and consists of four major subassemblies: the radiator support, two inner fenders (left and right) and the main body frame. All the subassemblies are held and located with respect to the fixture that defines the resulting dimensional relationships between these subassemblies.

In type-2 assemblies, some mating features can be chosen specifically to meet assembly requirements. Features can be chosen to selectively propagate variation along certain directions and absorb in other directions. This can be illustrated as follows, using simple 1-D slip plane² type features.

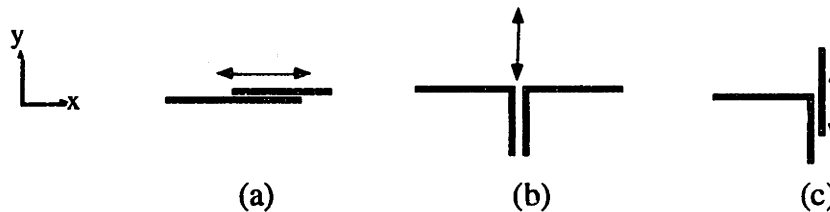

Figure 3-5: Some simple assembly features illustrating selective absorption of variation along the arrows

The slip plane in Figure 3-5(a) will absorb variation along the x direction and transmit it along the y direction while those in Figure 3-5(b) and (c) will absorb variation in the y direction and

² Slip planes are widely used in the automotive industry as variation absorption sites.

transmit it along the *x* direction. Hence, in type-2 assemblies, assembly design involves design of both location transfer and mating features.

3.2.2.1 KC deliverability problems

KC deliverability problems are typically associated with type-2 assemblies. These refer to the class of problems where assemblability problems may not occur but the assembly level KCs are not delivered to the desired level of acceptability. Figure 3-6 shows a typical assembly of compliant parts. Two alternate sequences are shown for these parts as well.

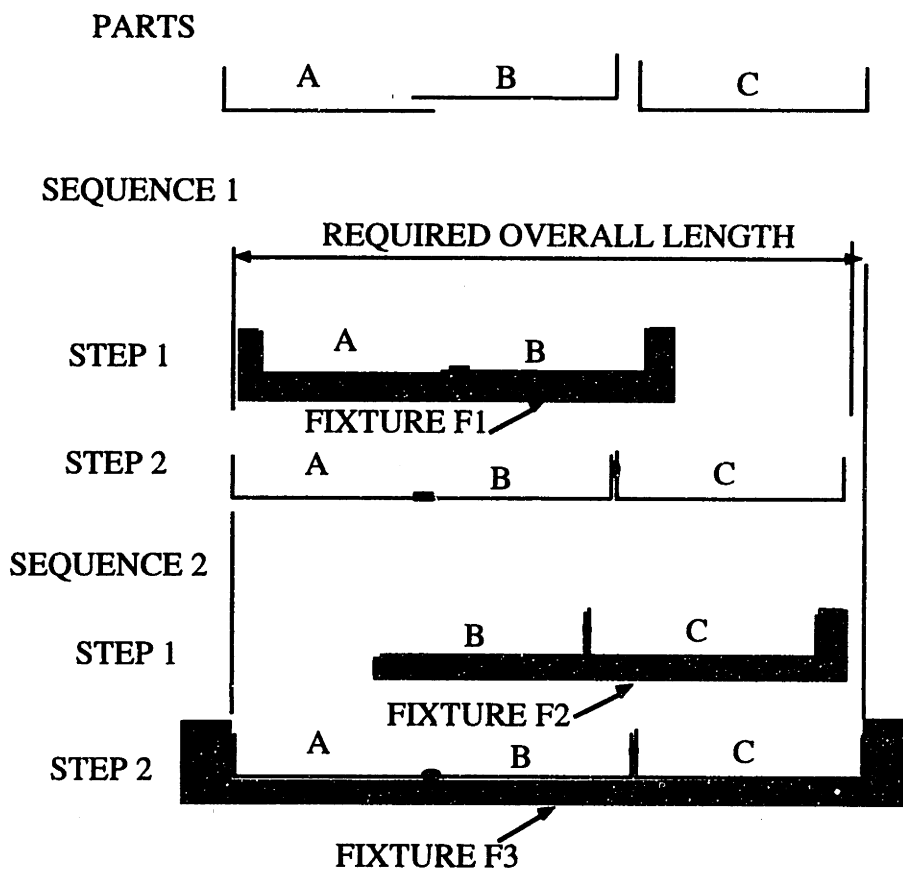

Figure 3-6: KC deliverability issues for type-2 assemblies: Comparison of two alternate assembly sequences for three sheet metal parts.

The first could fail to deliver an assembly of the required length. Parts A, B, and C are actually shallow shells or portions of shells. Part C's left flange could be bent to more or less than the desired 90° as shown, making the length of C uncertain. The overall length of the assembly has a tight tolerance on it. The exact amount of overlap between A and B is less important than the

overall length. Sequence 1 mates parts A and B first in Fixture 1, and then adds part C. The length requirement is not reliably met due to the uncertainty in part C's length. Sequence 2 mates parts B and C first on Fixture 2 and places them in Fixture 3. (Fixture 2 provides support only and does not control any lengths). Then part A is added to Fixture 3, overlapping part B. A and B are then joined, giving the correct overall length. Sequence 2 is said to "wash the uncertainty to a place where it does not matter."³

Figure 3-7 shows DFCs for these two sequences and again shows the differences clearly at an abstract level. The DFC for sequence 1 reads "F1 locates B with respect to A; then B locates C. The DFC for sequence 2 reads "F3 locates A and C, while C locates B." The dash line indicates a strength joint that carries no dimensional constraint. More self-explanatory DFC symbolism is needed and will be explained below. However, by inspection, one can see that sequence 1 does not establish a high quality positional relation between A and C while sequence 2 does. Again, this example is analyzed in detail in forthcoming chapters using the techniques developed.

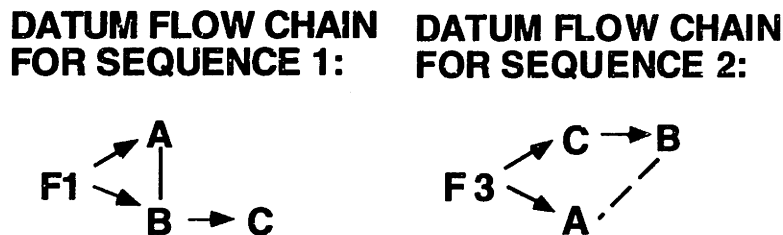

Figure 3-7: Possible DFCs for the Two Sequences in Figure 3-6.

The examples in Figures 3-2 to 3-6 show that modeling of the assembly process requires modeling the fixtures as well as the assembled parts themselves because the fixtures are temporarily part of the assembly, and the DFCs pass temporarily through the fixtures. The examples also show the advantages of performing tolerance analyses on intermediate stages of assembly, where for example the first two or three parts have been placed in proximity but have not been joined yet. These are non-traditional analyses and are not often performed. By permitting such analyses, the techniques developed as a part of this research will be of use in choosing a datum flow logic, selecting the type and location of assembly mating features,

³ This terminology is common in the auto industry.

designing the fixtures, and choosing an assembly sequence that delivers an assembly of the required quality.

3.3 Example assembly process studied: "Fixture-less" Aircraft Assembly

Aircraft fuselage parts are typically assembled on large, expensive, and inflexible fixtures. In order to accomplish this, master gages and various secondary gages are used. Parts are placed overlapping on fixtures, rivet holes are drilled using guides on the fixtures, and the parts are riveted.

Recently the aircraft industry has begun implementing assembly methods that rely less on fixtures. (Koonmen 1994). One method drills matching rows of a few temporary under-sized locating holes in individual parts during fabrication. During assembly, the parts are placed so that the holes line up, and undersize temporary fasteners are inserted by hand. Permanent fasteners are then installed by machine. To make these rows of holes line up, great care in controlling temperature is used in combination with oversize holes to accommodate remaining errors.

We carried out a project to design a fixture-less assembly technique for a four-piece wing skin assembly. The example is presented in chapter 4 and is discussed in detail in (Cunningham, et al. 1996). Figure 3-8 shows schematic representations of the parts. To meet the requirements for this assembly, it is necessary to align the skins to each other and to the plus chord very accurately. To do this without fixtures, we defined an assembly plan comprising a DFC that would position all the parts properly with respect to each other. Then we sought mating features that would perform this relative positioning in spite of $\pm 10^{\circ}\text{C}$ temperature variations and a very limited capital budget. Finally, we selected an assembly sequence using these features that would deliver the requirements 100% of the time, taking into account variations caused by temperature and machining errors. We executed this process using our own geometric reasoning skills plus software for generating assembly sequences by (Baldwin, et al. 1991) and the commercial tolerance analysis package VSA. Forthcoming chapters describe a structured approach to executing some of these processes.

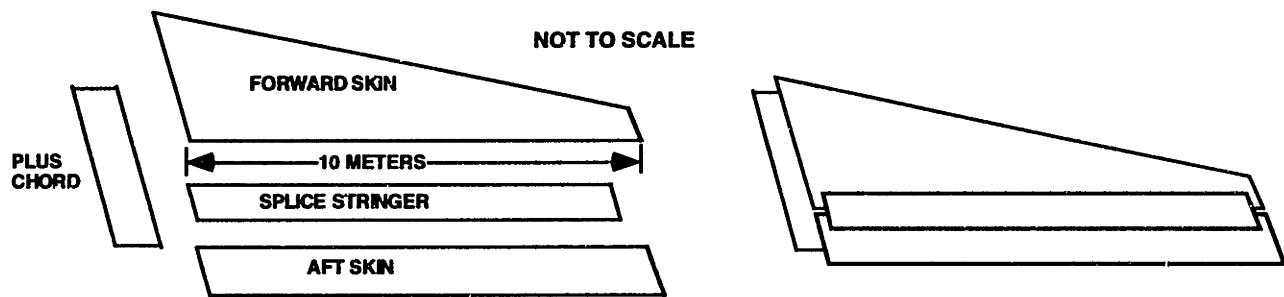

Figure 3-8: Schematic Representation of an Airplane Wing Skin Assembly. Left: The parts. Right: The assembly. The splice stringer is a stiffener wide enough to join the two skin pieces. Such assemblies contain many other stringers parallel to the splice stringer, but they are not shown here.

3.4 Summary of Scientific Issues

The above discussion pointed out the need for new knowledge in several areas related to assembly process modeling. They are summarized here.

3.4.1 Need for a "Circuit Diagram" for Assemblies

Assemblies have been modeled up to now in a non-hierarchical way. All connections between parts have been treated as equally important and have been thought of as providing connection and fastening. If we want to consider establishment and transfer of dimensional location, then some joints must be declared more important than others, namely, those which define geometric relationships as distinct from those that are redundant locationally and merely provide strength or support. If these distinctions can be expressed carefully and mathematically, then we can construct directed graph representations for dimensional transfer in a declarative way, providing a basis for synthesizing tolerance achievement rather than doing tolerance analysis on sets of geometric decisions whose underlying logical representation we have no way to represent. We developed the concept of Datum Flow Chain is to capture this logic. The properties of a DFC, its role in assembly design and planning, and scope are presented in detail in chapter 4.

3.4.2 Need for a "Layout Language" for Representing Assembly-level Requirements

As the example in Figure 3-4 shows, final assembly configurations can have overall dimensional constraints that are not represented on any one part or collection of parts. There are no features

on parts A and B that control how the lap joint between them should be aligned. The designer intended this, desiring that this joint be made last to absorb any remaining length uncertainty. A way to capture this train of reasoning is needed. At present, skilled domain experts called tooling designers recognize these conditions and invent joint types and fixturing schemes to provide the necessary dimensional constraint. These schemes are often spatial and are hard to understand. Consequently they are also hard to debug if they do not work as intended. It is our goal that a layout language based on the DFC, with the addition of well-defined symbols to capture types of joint and amount of constraint they apply, will permit layouts to be analyzed algorithmically to see if they actually deliver the requirements. Also, this domain knowledge can then be captured, formalized, taught, and used by designers and factory floor people. Chapter 4 describes some techniques that have been developed based on the DFC to perform such analyses. Mathematical tools developed to perform constraint and motion-limit analyses on assembly features are presented in [Refer to Jeff's thesis].

3.4.3 Need to Model Effects of Assembly Sequence

Choice of assembly sequence and identification of subassemblies focus attention on so many aspects of product design that they should be considered during early stages of design (Nevins, et al. 1989). Assembly sequence determines the order in which important dimensional relations between parts necessary for KC delivery in an assembly are achieved. A typical assembly can have a large number of feasible assembly sequences. It is not clear from this complete set of sequences which ones will deliver all the KCs repeatedly, and evaluation of the complete set is a time consuming task. There is a need for algorithms to analyze assembly sequences in conjunction with KCs, mating features, and dimensional hierarchy and quickly identify the sequences of interest. We have developed some such algorithms and they are presented in Chapter 4.

3.4.4 Need for Way to Include Fixtures in Assembly Models

Current assembly models represent the parts only. But we have identified several situations where the fixtures must be included in the models because the DFC passes through them during assembly. This is clearly awkward with existing modeling methods because the fixtures are only temporary members of the set and must be removed later. All existing methods for generating all feasible assembly sequences, for example, assume that each item added to the assembly stays there and is not removed. The examples in Figure 3-2 and Figure 3-4 show that DFCs can be

disjoint and that assembly sequences and DFCs can proceed from one fixture or part origin for a few steps and then completely start over in a new fixture, proceeding from a new origin. These situations are presented and modeled using the DFC in Chapter 4.

3.4.5 Need to Model Incomplete Assemblies

Existing methods for analyzing assemblies and tolerances assume that the assembly is finished and has the necessary nominal configuration as well as the full constraint of finished joints and fasteners. But the process of making the assembly step by step creates a series of incomplete assemblies that lack full constraint and may not have the correct nominal configuration yet. Still, the condition of these incomplete assemblies must be analyzed in order to determine if, for example, the DFC has any chance of delivering the required final dimensions and tolerances (the problem in Figure 3-4), or to see if any intermediate subassemblies are unstable or unable to receive other parts because of tolerance buildup (the problem in Figure 3-2). New algorithms are needed that can perform variation propagation analysis on incomplete and incompletely constrained assemblies at intermediate stages of the assembly process. Chapters 5 and 6 present a new modeling approach based on state space theory to develop such algorithms.

3.5 Approach

In the course of this research we have defined a top-down approach to modeling and analyzing assemblies and their assembly processes. This approach is presented using a flowchart in Figure 3-9. The method presents several techniques to represent and analyze assemblies at a conceptual stage of design in an attempt to satisfy some of the needs outlined above. The process starts by carefully identifying the assembly requirements from the top level customer requirements down to the fabrication of individual parts using a method called Key Characteristics (KCs) (Lee 1995). KCs are intended to capture a few important characteristics of the product, differentiating them from the large number of un-prioritized tolerances that normally appear on engineering drawings. These KCs are expressed first as customer requirements and then translated to supporting engineering specifications for assemblies and parts. Assembly features are the local geometry regions on parts that assemble to like regions on other parts. The KCs are then used to identify important datums on parts and subassemblies, and to define relationships between them.

A detailed description of the different types of KCs can be found in (Cunningham, et al. 1996, Lee 1995.).

The Datum Flow Chain assigns a hierarchy to the above-identified datums and defines which parts locate which other parts in the assembly. A DFC is a graphical representation of the designer's strategy to locate the parts with respect to each other, which amounts to specifying the underlying structure of dimensional and datum references on parts constituting the assembly. The DFC is used to plan assembly sequences. First the complete feasible set of assembly sequences for the assembly is identified based on geometric constraints. Then the DFC is used to prune the set to a smaller set of assembly sequences based on the order of establishment of these dimensional references. We call this smaller set as a family of assembly sequences. Candidate assembly feature sets are designed that implement the structure of dimensional and datum references imposed by a DFC. Candidate DFCs are evaluated and compared using criteria such as KC deliverability and tolerance analysis.

Different procedures are employed for type-1 and type-2 assemblies. For the former, the selection of mating features is determined by considering function and is not a part of the assembly planning process. For the latter, feature type and location selection is a crucial part of the assembly process design. The design of these mating features in both types of assemblies places requirements on the assembly and fabrication processes. The DFC is then used to construct tolerance chains to perform a three dimensional tolerance analysis and choose between assembly sequences and feature sets within the most promising family identified. The end result of the exercise is a location strategy reflected in the choice of dimensional datums and their hierarchy (DFC), an assembly feature set, and an assembly procedure that satisfies the DFC hierarchy. The DFC allows the designer to explore the consequences of choosing different dimensioning, locating and fixturing schemes on the deliverability of KCs, choice of assembly sequence, assembly feature design.

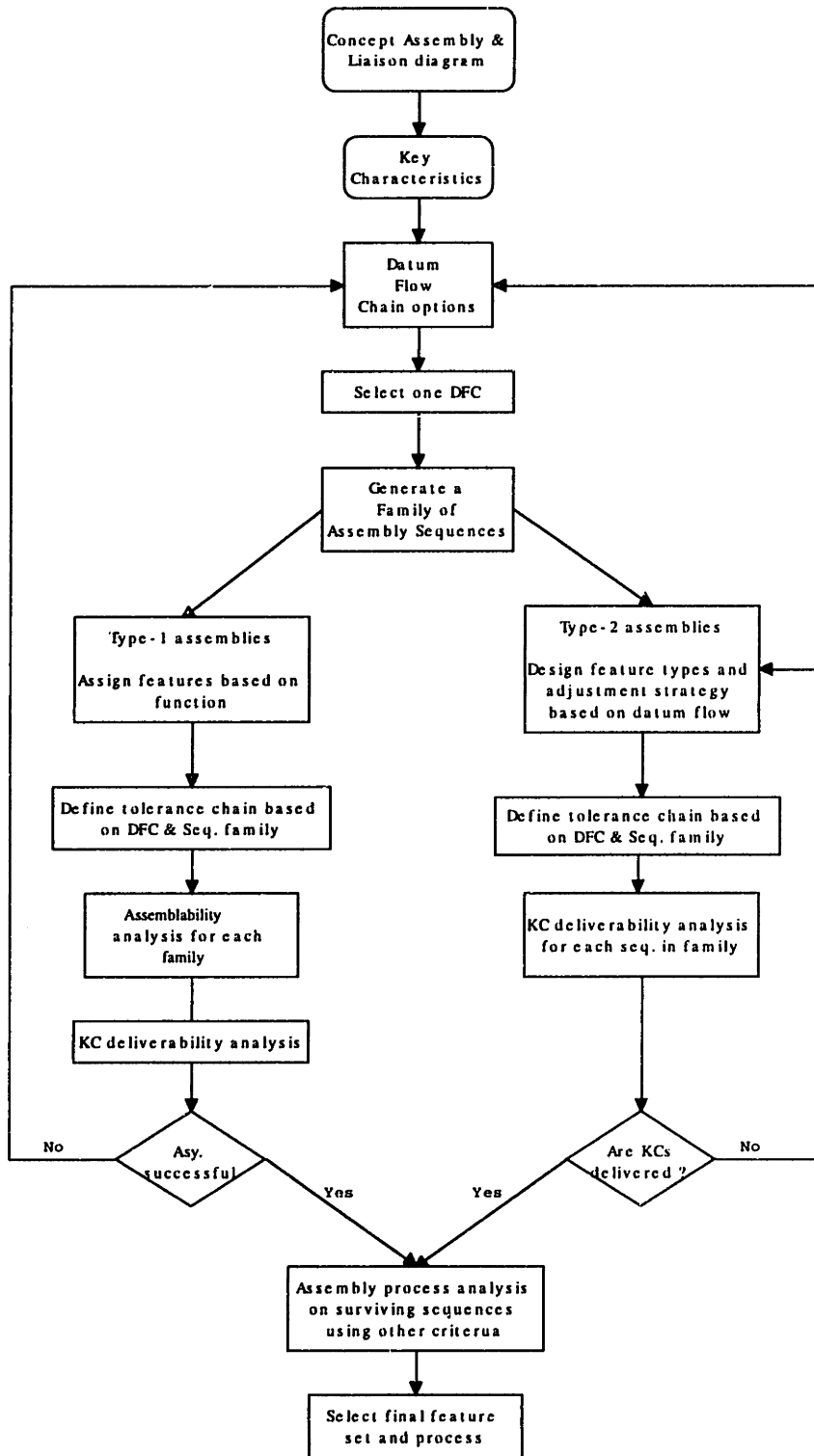

Figure 3-9: A flowchart for the assembly oriented design system

In this view, design of the assembly process is driven directly by customer requirements and is implemented by selecting datum flow chains while only a skeleton of the assembly's logic and

sketches of the parts exist. Detailed part geometry plays almost no role (except in the neighborhood of the assembly features), even though assembly sequence and tolerance analysis are performed. The following chapters describe the different elements of the assembly oriented design approach in detail.

3.6 Summary

This chapter identified the limitations of existing knowledge in several areas related to assembly modeling and the inability of current modeling approaches to address all types of assembly problems. It identified important elements of design that need to be studied during early stages of design and presented a top-down framework to address these elements. Assemblies were classified into two major types based on their characteristics and associated assembly problems. Different problem scenarios for these assemblies were presented using real examples from industry. Using these examples, need for new knowledge to model assemblies and assembly processes was identified. An assembly oriented design framework was defined and several modeling techniques were presented to satisfy the needs identified. The following chapters describe these techniques in detail and illustrate their applications using examples from industry.

"What most experimenters take for granted before they begin their experiments is infinitely more interesting than any results to which their experiments lead."

-- Norbert Wiener

4.

Datum Flow Chain

4.1 Overview

This chapter introduces the Datum Flow Chain as a technique to model the design of assemblies at a conceptual stage. The concept of the DFC and its properties and relationship to KCs are described in section 4.2. The two types of assemblies mentioned in chapter 3 are described in section 4.3. The DFC provides for a structured method of planning out the assembly procedures which are described in section 4.4. Section 4.5 presents analysis techniques to choose between alternate DFCs. Section 4.6 summarizes the modeling approach and presents directions for future research.

4.2 Datum flow chain

4.2.1 The concept

An assembly is characterized by a set of key characteristics (KCs) that it has to deliver upon final assembly. These are assembly level dimensions relating a datum or feature on one part to that on

another part in the assembly. An example KC is the size and straightness of the gap between a car hood and fender. Typically, such KCs are achieved (or delivered) when several different parts are made and assembled correctly. The dimensional relations between parts are defined at their mating points (features). A typical part in the assembly has multiple joints with other parts in the assembly. Not all of these joints transfer dimensional constraint, and it is essential to distinguish the ones that do from the ones that are redundant location-wise and merely provide support or strength. We define the joints that establish dimensional relationships between parts as “*mates*,” while joints that merely support and fasten the part once it is located are called “*contacts*”. Hence mates are directly associated with the KCs for the assembly as they define the resulting assembly dimensions. The process of assembly is not just of fastening parts together but should be thought of as a process that first defines the location of parts using the mates and then fastens the parts together once their location has been defined. The mates are fastened first and only then can the contacts be fastened.

Explicit identification and definition of the mates in the assembly is an integral part of assembly design and is a pre-requisite to assembly process planning and variation stackup analysis. The designer makes the choice of which joints will be mates and which ones will be contacts at the conceptual design stage. Joints directly involved with the delivery of KCs are declared as mates. If these distinctions can be expressed carefully and mathematically, then we can construct directed graph representations for dimensional transfer from mate to mate in a declarative way, providing a basis for synthesizing tolerance achievement. We call this directed graph of *mates* the *Datum flow chain (DFC)* (Mantripragada, et al. 1996). It assigns a hierarchy to the joints between parts by defining which part(s) or fixture locates which other part(s) in the assembly. In some assemblies, *mates* are accomplished in whole or in part by supporting fixtures that have to be included in the DFC.

Assembly design involves designing the datum flow chain explicitly to determine the location strategy before performing any kind of analysis. DFCs express the designer’s logical intent concerning how parts are to be related to each other geometrically to deliver the KCs repeatedly. When defining the DFC, the designer must define explicitly the surfaces or reference axes on mating features that are intended to carry dimensional constraint to the mating part. Standard

methods to define such relationships inside a part exist today (ANSI Y14.5M standards), but no such standards exist for creating DFCs at an assembly level as described here. In a manner similar to how the dimensioning scheme within a part determines the procedures that can be employed to fabricate the part, the DFC severely constrains the permissible assembly procedures that can be followed to build the assembly.

4.2.2 Assumptions

The following assumptions are made to model the assembly process using a DFC:

All parts in the assembly are assumed rigid. Hence each part is completely located once its position and orientation in three-dimensional space are determined.

Each assembly operation completely locates the part being assembled with respect to existing parts in the assembly or an assembly fixture. Only after the part is completely located is it fastened to the remaining parts in the assembly.

4.2.3 Properties of a DFC

A datum flow chain is a directed acyclic (a graph with no cycles) graphical representation of an assembly with nodes representing the parts and arcs representing *mates* between them (Mantripragada, et al. 1996). Every node represents a part or a fixture and every arc transfers dimensional constraint from the node at the tail to that at the head. Loops or cycles in a DFC would mean that a part locates itself once the entire cycle is traversed, and hence are not permitted. Every arc constrains certain degrees of freedom depending upon the type of mating conditions it represents. The sum of the degrees of freedom constrained by all the incoming arcs to a node (called the in-degree) in a DFC should be equal to six unless there are some kinematic properties in the assembly or designed mating conditions such as slip joints which can accommodate some amount of pre-defined motion. Each arc has an associated 4x4-transformation matrix that represents mathematically how the part at the head of the arc is located with respect to the part at the tail of the arc. A typical DFC has only one root node that has no arcs directed towards it, which represents the part from which the assembly process begins. This could either be the base part or a fixture.

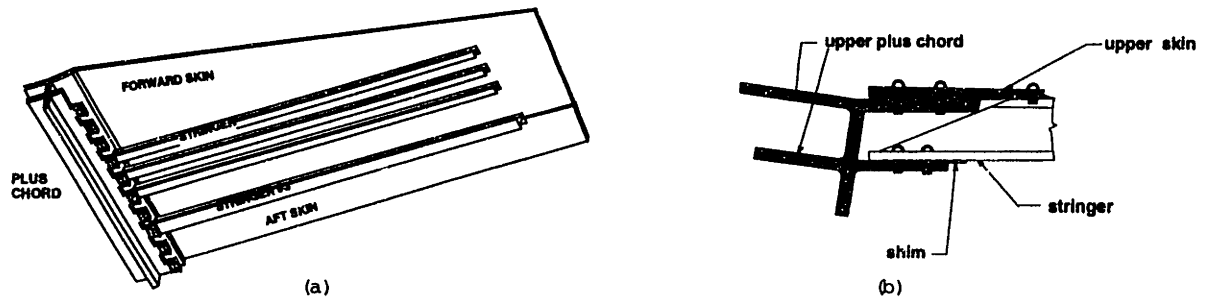

Figure 4-1: Example assembly (Airplane horizontal stabilizer upper skin assembly)

Consider the aircraft horizontal stabilizer skin assembly shown in Figure 4-1. It consists of four main parts: Plus-chord, Aft-skin, Fwd-skin and 11 stringers. Stringer 3 is called the splice stringer because it splices the forward and aft skins to each other. A traditional representation of the assembly using a liaison diagram is shown in Figure 4-2(a). A liaison diagram is an undirected graph where the nodes represent parts and the arcs represent liaisons (contacts or mates) between them (DeFazio, et al. 1987). A candidate DFC for the assembly is shown in Figure 4-2(b). As shown in the figure, it is a directed graph of mates only.

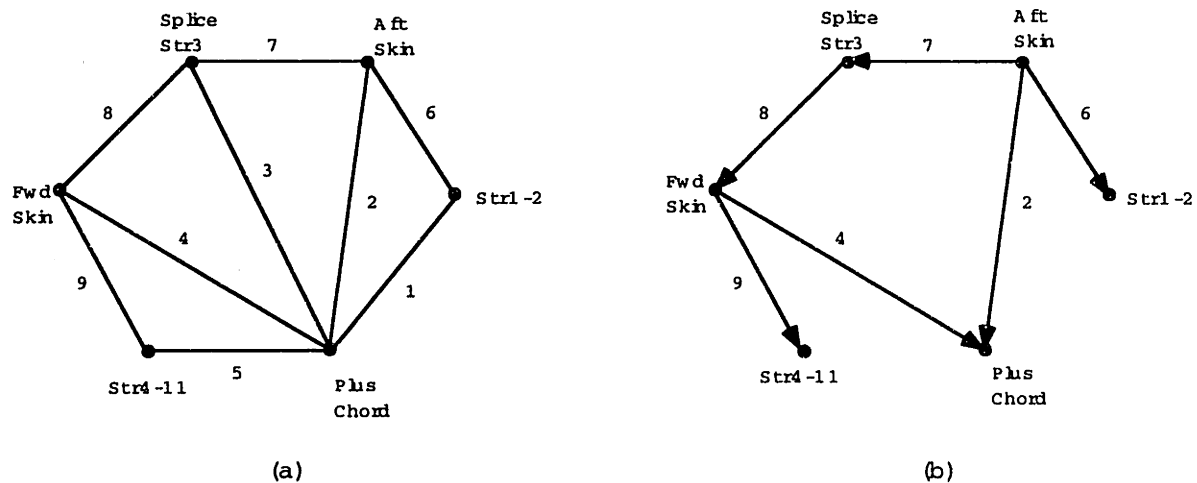

Figure 4-2: (a) Liaison diagram and (b) Datum flow chain for the assembly in Figure 4-1

The DFC in Figure 4-2(b) states that the location of Stringers 1-2 and splice stringer-3 is determined completely by mating features on the Aft skin. The Aft and Forward skin together locate the Plus-chord. Mating features on the Fwd skin locate stringers 4-11. Liaisons 7, 8, 2, 4, 6, and 9 are thus mates while liaisons 1, 3, and 5 are contacts. The features used to assemble the stringers to the plus chord should allow for absorption of part variations and avoid forming an

over constrained assembly. In case the chosen features at the plus chord-stringer interface are holes, they should be over sized. A suitable set of mating features for this assembly is described in (Cunningham, et al. 1996).

4.3 Types of assemblies

We shall now redefine type-1 and 2 assemblies with reference to the DFC.

4.3.1 Type-1 assemblies

Defined in terms of the DFC, a type-1 assembly is one where every part has at least one *mate* with at least one other part in the assembly. Fixtures, if present, merely immobilize the base subassembly and present it to the part being assembled in the desired position and orientation.

4.3.2 Type-2 assemblies

Defined in terms of the DFC, a type-2 assembly is one where it is possible to have only *contacts* between all parts in the assembly. In such cases, the parts will have *mates* with fixtures used to locate them. In-process measurements can be made to adjust the location of these parts during assembly to tune out the effects of variation caused by the manufacturing processes used to fabricate the parts. Hence we call these “*assembly-defined*” assemblies, as the assembly process can redistribute the variation. Typically, a type-2 assembly will have a mixture of mates and contacts making in-process adjustments possible only at certain locations and not at others. In the extreme that there are mates between every part in the assembly, type-2 reduces to type-1.

4.4 Assembly design and planning using DFC

Most assembly planning systems developed in the past have treated assembly planning as an activity separate from product design. Assembly plans are developed after all the individual parts are designed. Often a problem with this approach is that the choice of assembly methods is not consistent with the design of the products because assembly considerations were not made during product design. This leads to fit-up problems during assembly that are hard to diagnose. The DFC allows for a top-down approach to designing assemblies. This approach starts with carefully identifying the assembly requirements from the top level customer requirements down to the fabrication of individual parts using a method called Key Characteristics (KCs). These

resulting specifications are then used to define candidate datum flow chains (DFC) for the assembly. Next, the mating and assembly features that carry the datums and establish the relationships imposed by the DFC are designed. Different procedures are employed for type-1 and type-2 assemblies. For the former, the selection of mating features is usually determined by considering function and may not be determined by the assembly process. The assembly process can however affect the tolerancing and dimensioning of these features and the fixturing options during assembly. For the latter, feature type and location selections are a crucial part of the assembly process design. The DFC is then used to reason assembly sequences based on the order of establishment of these dimensional references and to identify assembly sequences that will deliver KCs consistently. The following sections describe this approach in detail using an example study of a 767 horizontal stabilizer assembly. A brief description of the assembly will be given first and then developed techniques will be illustrated using the example assembly.

4.4.1 Example assembly: Boeing 767 Upper skin assembly

The horizontal stabilizer is located at the aft end of an aircraft, enabling the aircraft to climb and descend by pivoting up or down to direct airflow, and balancing the moments of the aircraft (see Figure 4-1). The principal requirements for this structure are to carry aerodynamic loads while minimizing the drag it creates so overall system efficiency is maximized. The assembly is comprised of three main sub-assemblies: left and right wings and a center box. The stabilizer in this case study pivots about its long axis as a solid unit on two points, one at the aft end of each stabilizer, by the motion of an actuator that moves the front of the center box up and down. Each horizontal stabilizer wing (see Figure 4-2, Figure 4-3) are comprised of the following subassemblies:

Forward Torque Box, including the forward spar

Main Torque Box, consisting of:

- Pivot Rib at the root of the main torque box

- Upper Skin Assembly

- Lower Skin Assembly

- Ribs

- Fixed Trailing Edge, including the aft spar

Our case study is the family of upper and lower skins for several aircraft of similar construction but different in dimensions. The upper skin assembly is the example discussed in detail in this paper. It forms the top of the main torque box, the main structural body of the stabilizer shown in the exploded view in Figure 4-3.

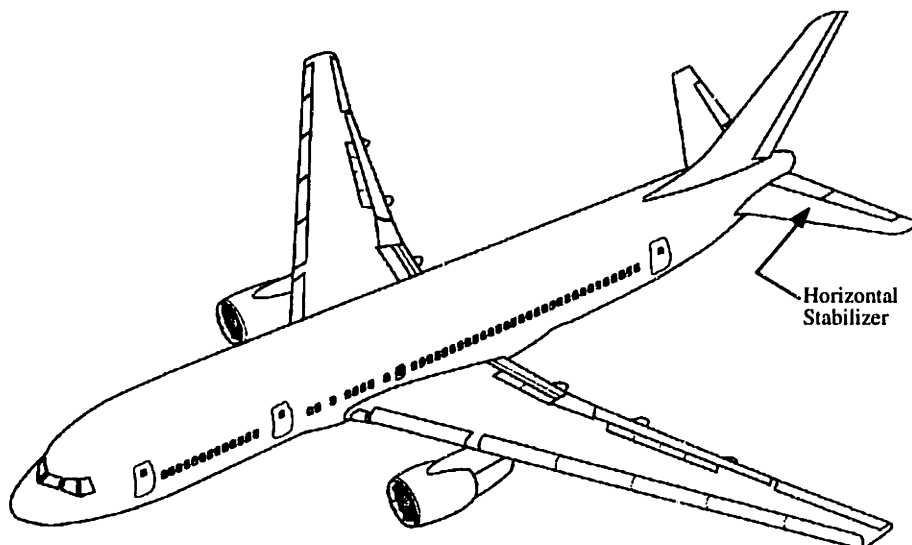

Figure 4-3: Horizontal Stabilizer position on the aircraft.

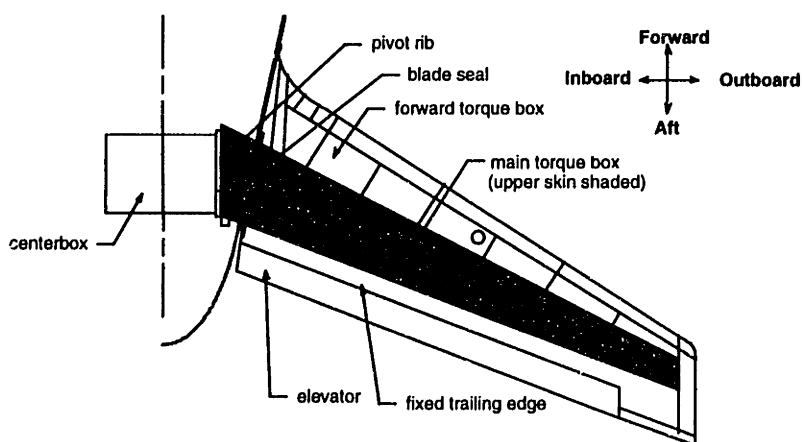

Figure 4-4: Horizontal stabilizer top view.

This type of assembly is typically between 30 and 60 feet long and 5 to 10 feet wide. The main torque box sustains differential loads on the upper and lower surfaces and torsional loads along the length of the stabilizer. Figure 4-4 also denotes the reference frame used in this thesis,

showing the inboard, outboard, forward, and aft directions. As shown in Figure 4-4, the upper skin assembly includes the following parts, all of which are machined aluminum and shot peened⁴ to improve corrosion and fatigue crack resistance:

Forward Skin - a long sheet of varying thickness that carries compressive and tensile loads and forms the aerodynamic surface.

Aft skin - similar to the forward skin; the aft skin acts as an access panel during assembly of the horizontal stabilizer.

Stringers - long, slender beams (with Z, I, or J cross-sections) that serve to stiffen the skins along the full length to minimize weight and maximize stiffness. They are riveted directly to the skin and fastened to the plus chord. Stringer -3 serves as a splice between the two skins (visible in Figure 4-5), while the other stringers are fastened to just one of the skins.

Plus Chord - a heavy heat-treated, machined extrusion that forms the top of the pivot rib at the root of the main torque box, where maximum loads in the stabilizer are absorbed. The complex geometry and intricate processing steps make the final shape of the plus chord difficult to control.

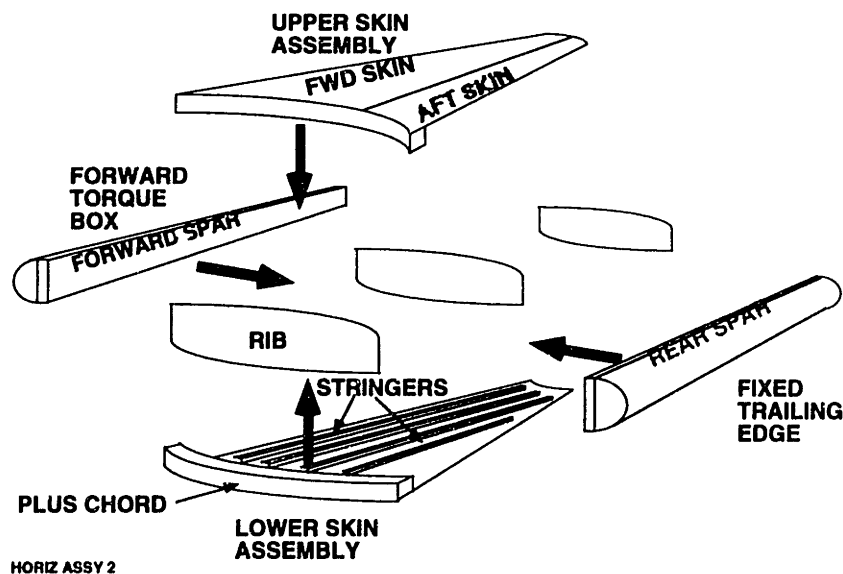

Figure 4-5: The horizontal stabilizer assembly shown in exploded view

⁴ The shot peen process distorts the shape of parts after machining, with the most significant distortion being growth on the order of 0.0001 inch of growth per inch of length. This is a significant source of variation, and is common to all parts of this type in aircraft.

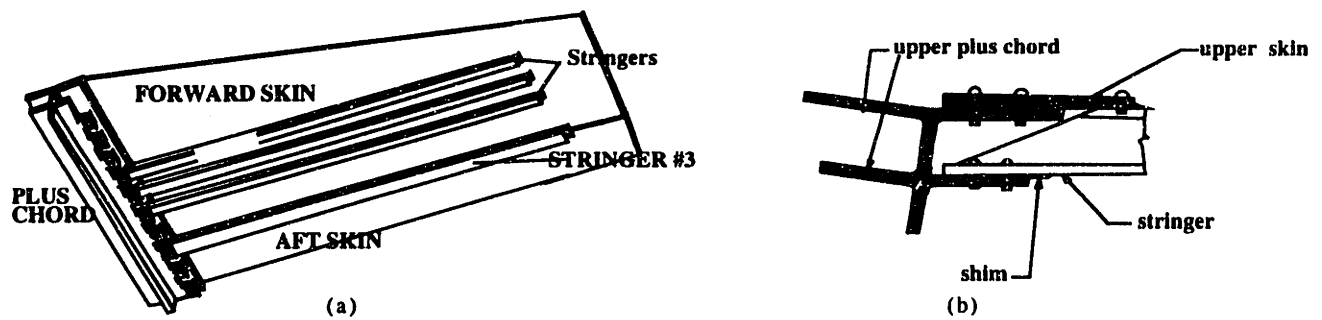

Figure 4-6: (a) Upper skin assembly from lower view (b) In-board cross-section view of the upper skin assembly and plus chord

The plus chord and splice plates join the left and right main torque box to the center box. Figure 4-6(b) shows a section view of the inboard part interfaces on the main torque box side of this joint, which is a mirror image of the interfaces on the center box side of the joint. Shims are used to fill assembly gaps between the plus chord and the stringer, with each made to a different thickness by hand. The actual skin assembly is contoured along the forward to aft axis, as represented in Figure 4-5, and along the length of the stabilizer.

4.4.2 Key Characteristics and DFC design

Key Characteristics are a product's geometric features and material properties that are highly constrained or for which minute deviations from nominal specifications (regardless of manufacturing capability) have a significant impact on the product's performance, function, and form at each product assembly level. KCs come directly from the customer requirements and are flowed down in a systematic manner from assembly to subassembly to part level.

The high level KCs for the horizontal stabilizer mainly deal with aircraft drag and control issues from Federal Aviation Agency (FAA) regulations, aircraft loads carried by the structure as certified by the FAA, aerodynamic specifications, and airline customer requirements. Figure 4-7 shows the KC flowdowns described below that are shaded at the point where they affect our analysis of the upper skin assembly.

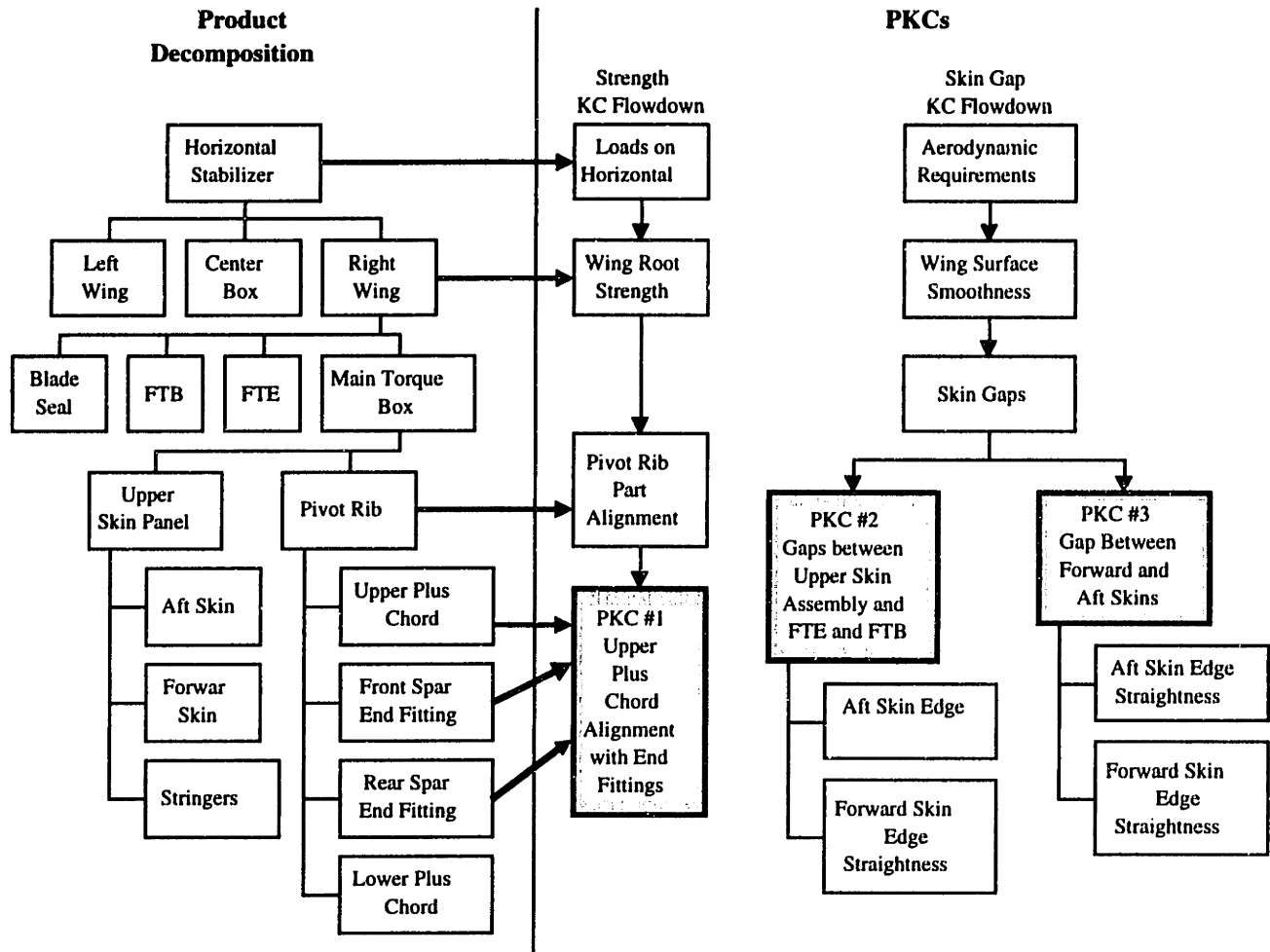

Figure 4-7: Product Decomposition and resulting KCs.

The upper skin assembly is affected by load certification and aerodynamic requirements and these two issues produce three KCs of importance. Structural loads require the parts making up the pivot rib be accurately aligned (dimensionally +/- 0.005in), which flows down to:

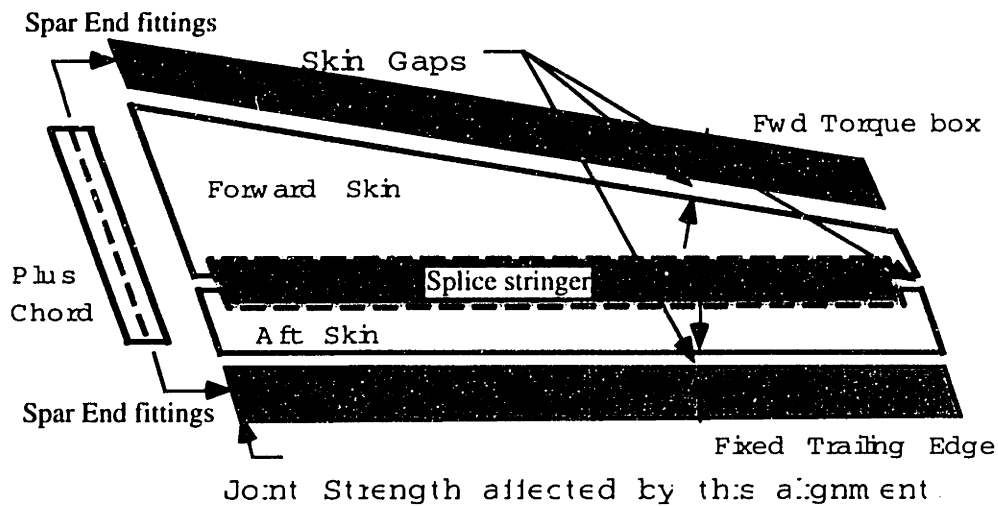

Figure 4-8: KCs for the horizontal stabilizer upper skin assembly

: Upper plus chord alignment to spar end fittings.

The skin gaps must be accurate and consistent (nominal +/- 0.030in), which flows down to:

: Gaps between the skins on the upper skin assembly and those on the Forward Torque Box and Fixed Trailing Edge, and

: Gap between the forward and aft skins of the upper skin assembly.

Wing roots require very tight tolerance alignment of the plus chord to other parts of the root in order to properly absorb the dynamic distributed loads (Niu 1988). This requirement is so important that, on some wing-like structures, if there is any alignment mismatch, a structural analysis is required to ensure that proper safety margins are maintained for that set of parts; this is costly but is required if fit-up is not achieved. Skin gaps are critical to the smoothness of the wing because the sealant used to fill these gaps (creating a continuous surface for airflow) will flake out if the gaps are outside the specified tolerance. A detailed description of the KC identification and flowdown process for the assembly can be found in (Cunningham, et al. 1996).

Identification of all the KCs and their flowdown for the assembly is a pre-requisite to DFC design. The decision of which liaisons are to be mates and which ones are to be contacts is a conscious decision made by the designer based on the KC requirements for the assembly. Joints directly associated with the delivery of KCs should be designated as mates and tightly toleranced

during the design and monitored during the assembly process. The choice of assembly procedures and fixturing methods determine how these KCs will be delivered during assembly.

4.4.3 Decomposition and Subassembly design

The choice of which liaisons are to be mates and which are to be contacts determines the decomposition of the assembly and the permissible set of subassemblies. This choice is usually driven by the KCs for the assembly but can sometimes also be driven by assembly limitations. This situation is illustrated here using the horizontal stabilizer upper skin assembly. It is desirable to de-couple the KCs during assembly, so that the assembly process can deliver and control them separately. A desired DFC using fixtures to repeatedly deliver these KCs is shown in Figure 4-9. The plus-chord -skin and plus-chord -stringer joints are labeled as contacts as they are not directly associated with the delivery of any KCs. Contacts are shown as dashed lines in the DFC.

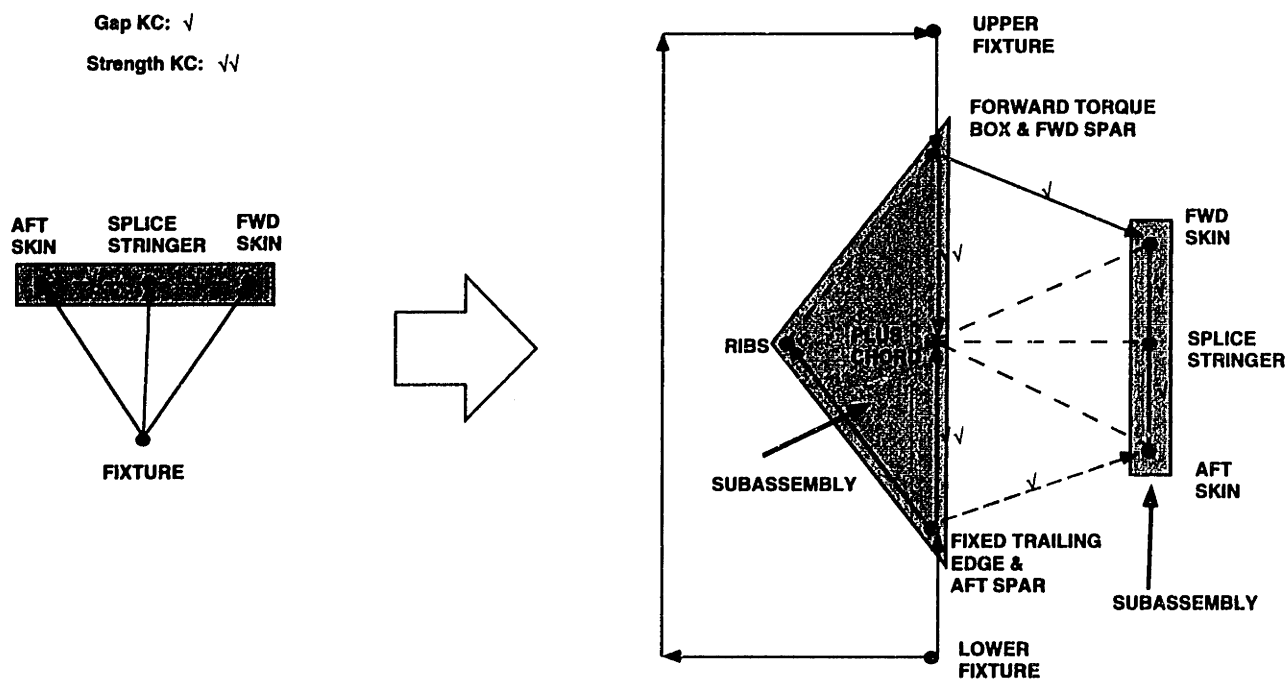

Figure 4-9: Desired DFC for delivering the KCs for the assembly

The resulting assembly sequence is shown in Figure 4-10. This sequence was physically not realizable. Once the plus chord was assembled to the FTB and FTE, there was no access left to assemble the upper skin assembly to the plus-chord. A desirable assembly sequence that would do so is shown in Figure 4-10.

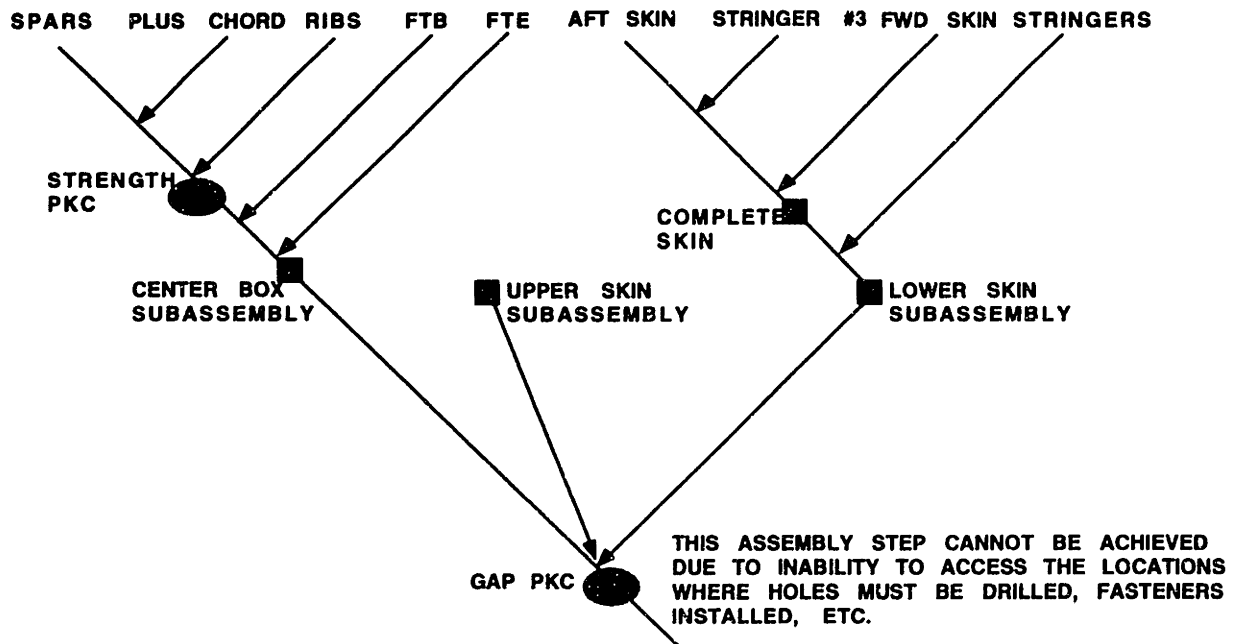

Figure 4-10: A desirable but impossible sequence for the horizontal stabilizer assembly

A modified DFC shown in Figure 4-11, had to be designed to successfully assemble the parts. To achieve the KCs, the joints between the plus-chord and the skins are now defined as mates and controlled carefully during design and assembly. This resulted in a different decomposition of the assembly. The Plus-chord is now part of the upper-skin assembly that is assembled as one unit to the leading and trailing edges. KCs 1 and 2 are tightly coupled in this decomposition. A priority needs to be assigned to the two KCs. The new DFC assigns a higher priority to the alignment KC. The mates between the plus chord and end fittings together with the mates between the plus chord and the skins determine the quality of the skin-gap KC. Thus, this KC is indirectly delivered.

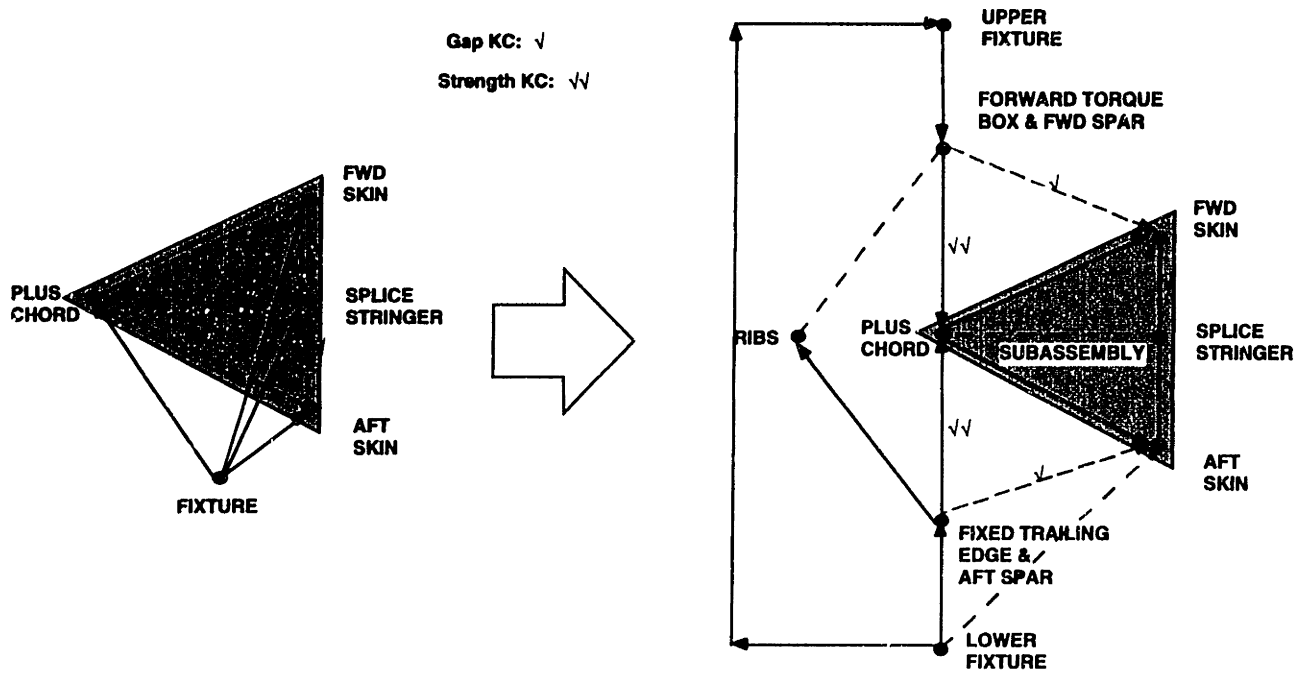

Figure 4-11: Modified DFC that was actually implemented due to assembly constraints

The resulting assembly sequence that was feasible but not desirable due to the KCs being coupled is shown in Figure 4-12.

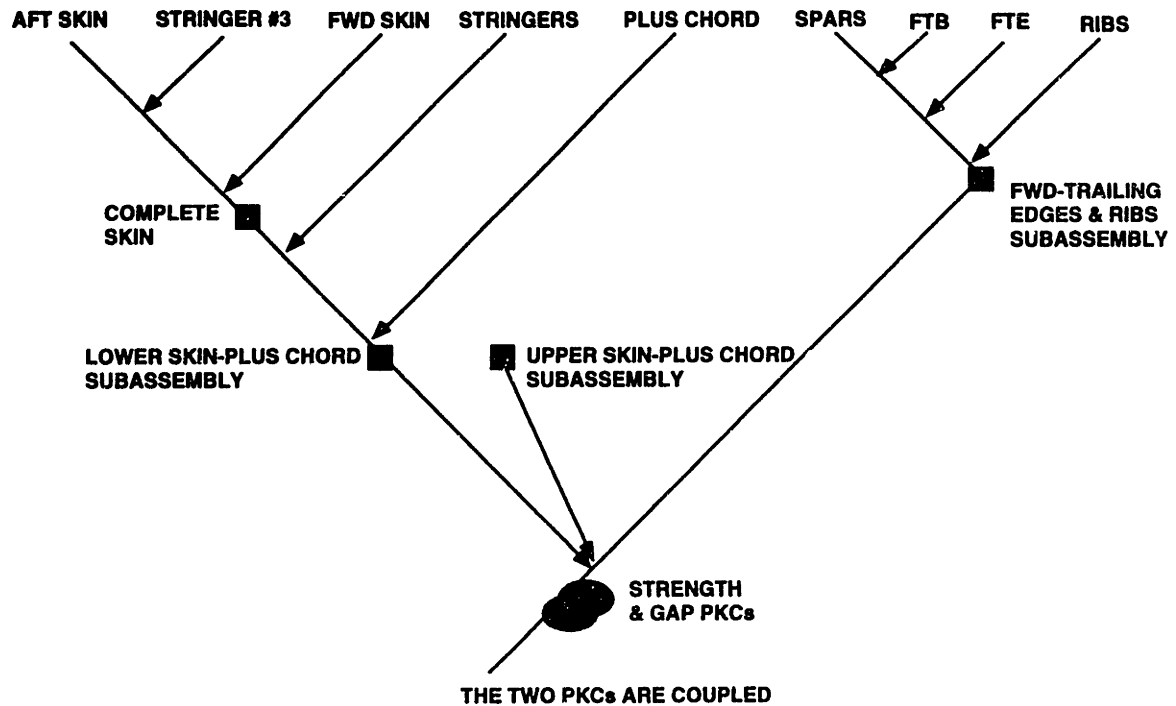

Figure 4-12: Resulting feasible but undesirable assembly sequence that was actually implemented

4.4.4 Mating feature design: designing locating schemes

In type-1 assemblies, the datum flow and mating features between parts are determined by considering almost exclusively the desired function of the assembly. Hence the designer may not have enough freedom to design the mating features specifically to suit assembly needs. However, in the case of type-2 assemblies, the designer has a lot more freedom to design these assembly mating features to locate parts with respect to each other or a fixture. In these assemblies, the choice of assembly features and DFC design are tightly coupled. Designing a locating scheme for these assemblies involves first determining at a very high level what part(s) locates what other part(s) in the assembly and then iteratively designing the assembly features that will accomplish the location. Since each arc in a DFC is a mate, an appropriate feature or feature set has to be chosen to accomplish the mate. This feature must constrain the required dof to perform its function as a mate and absorb uncertainties in other directions such as thermal expansion, etc. The absorption directions are perpendicular to the DFC mate directions. This is illustrated by the following example:

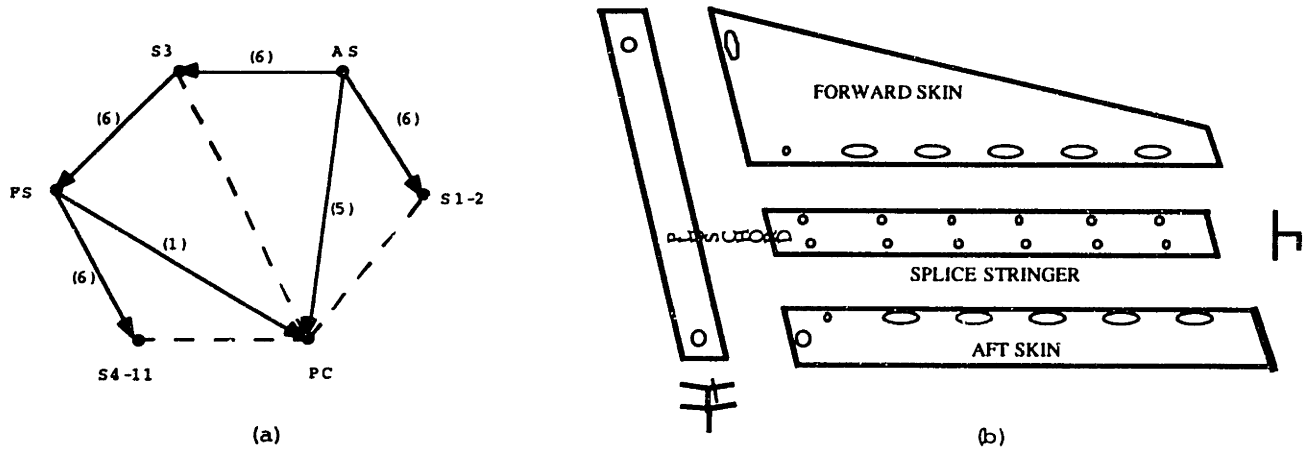

Figure 4-13: (a) A DFC for the assembly in Figure 4-1 (b) a possible feature set implementation to carry the datum logic defined by the DFC in (a)

The current method used to assemble the upper skin assembly relies on expensive hard tooling to establish part locations, operator intervention to overcome part and process variation, and custom shimming to fill inconsistent assembly gaps. Although the process delivers an acceptable product for the downstream assembly process, it is completely inflexible and an expensive way to achieve it. To make the assembly process more flexible and independent of hard locating fixtures, a flexible assembly concept was explored. This concept was based on using accurate mating features on parts to locate other parts that they mate with in the assembly. These features are called “assembly features”, as their primary function is to locate a part with respect to its mating parts. Figure 4-13(b) shows one possible feature set implementation of the DFC in Figure 4-13(a). The numbers on the arcs in the DFC indicate the number of dof determined by the mate. The mating features were chosen to locate parts with respect to each other and to absorb thermally induced size differences between parts. These features are formed during fabrication along with all the other features such as edges and surfaces. The holes were chosen for location and the slots to account for variation caused due to thermal expansion and shot peen growth accommodation. The mating features are joined with temporary bolts until permanent fasteners are installed. The final assembly is constructed by riveting through these features and knocking out the temporary fasteners, as slots were not allowed in the final assembly. The assembly sequence chosen was to construct the aft-skin, forward skin and splice stringer subassembly first and then assemble the resulting subassembly to the plus-chord.

4.4.5 Assembly sequence planning

Typically, for any assembly there can be a large number of feasible assembly sequences. De azio and Whitney(DeFazio, et al. 1987), Homem De Mello (Mello 1989), Bourjault (Bourjault 1984), have developed algorithms to generate assembly precedence relations based on the geometric reasoning and interference analysis. These precedence constraints were then used to generate a complete set of feasible assembly sequences. The complete set of assembly sequences is represented by an assembly sequence graph (DeFazio, et al. 1987). It is not clear from this assembly sequence graph which sequences will deliver all the KCs repeatedly, and evaluation of the complete set of assembly sequences is a time consuming task. We describe an approach to assist pruning the assembly sequence graph into a smaller manageable set of assembly sequences using the DFC. We call this set a *family* of assembly sequences.

4.4.5.1 Assembly precedence constraints

Traditionally, methods employed to generate all possible assembly sequences for a given assembly have treated all liaisons to be of the same type and have not made the distinction between “mates” and “contacts” as pointed out in Section 3. Generating all possible assembly sequences is done by representing all the geometric and mechanical assembly constraints as assembly precedence constraints. For example, the cut-set method (Baldwin 1989) generates all possible part combinations and tests the connectivity of the subgraph formed by a combination of parts or nodes in the liaison diagram. All connected subgraphs are possible subassemblies in this approach. We argue that not all possible subassemblies are desirable and emphasize the need to only consider the assembly sequences that generate the desirable ones. We define desirability of subassemblies in terms of the ability of the assembly process to deliver a dimensional tolerance on KCs. The following describes the procedure to identify desirable subassembly states using the DFC.

The design of a DFC involves the conscious decision of designing mates and contacts. As mentioned earlier, contacts do not define any dimensional relationships between parts and have to be established only after the mates that define the dimensional relationships are made. Using this argument, the following rule is imposed by the DFC:

Contact rule: *Only connected subgraphs in a DFC can form permissible subassemblies*

Subassemblies with only "contacts" between any two parts are not permitted because contacts do not contribute to a KC. This rule will thus generate additional assembly precedence constraints that eliminate subassemblies whose parts do not establish part of a DFC.

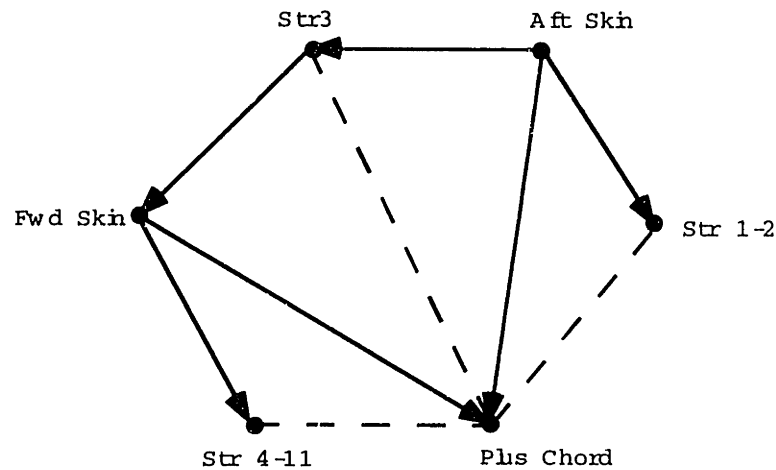

Figure 4-14: A candidate DFC for the upper skin assembly showing mates and contacts

For example in the DFC shown above in Figure 4-14 for the horizontal stabilizer assembly, a subassembly consisting of plus chord and stringers is not permitted as there are no intended features on the plus chord that would mate with those on the stringers. The plus chord has only contacts with the stringers (shown as dashed lines in the figure).

If the location of a part is defined by more than one part in the assembly, all the defining elements should be present in the subassembly before the part can be assembled. This argument is defined in the following rule:

Constraint rule: *Subassemblies with incompletely located (under-constrained) parts are not permitted*

The constraint rule imposes the condition that the in-degree of all but one of the nodes in a subassembly must add up to six. The one exceptional node could represent either a base part or a

fixture, and has an in-degree equal to zero. This rule ensures that every subassembly has fully located parts.

Both these rules are translated by a computer program into assembly precedence constraints connecting liaisons with ordering operators. The precedence constraints take the following form; similar to the approach followed by DeFazio and Whitney(DeFazio, et al. 1987):

$$(i \ \& \ j) \geq (k \ \& \ l) ;$$

The operator " \geq " means "must precede or concur with". The above constraint is read as: liaison i and j must be completed before or concurrently with, completion of (both) liaisons k and l (but not necessarily before or concurrently with either liaison k or l).

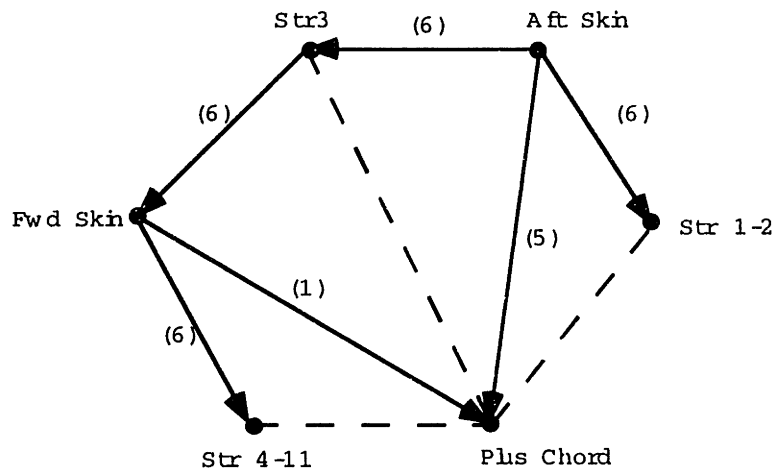

Figure 4-15: A candidate DFC for the upper skin assembly showing number of degrees of freedom constrained by the mates. Contacts shown as dashed lines

For example, for the DFC shown in Figure 4-15, the following subassemblies are not permitted:

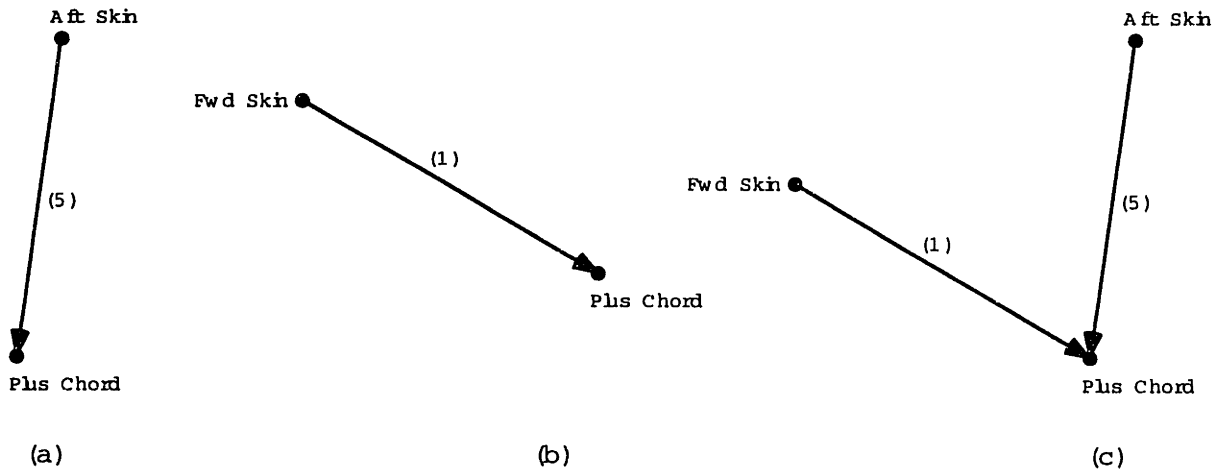

Figure 4-16: Incompletely constrained subassemblies not permitted by the Constraint Rule for the DFC in Figure 4-15

Subassemblies in Figure 4-16(a) and (b) are incompletely constrained assemblies and hence are not permitted. Subassembly in Figure 4-16(c) is not permitted because it violates the properties of a DFC. A DFC can have only one root node with no incoming arcs that would form the base part or fixture for the assembly. The permissible sets of subassemblies are:

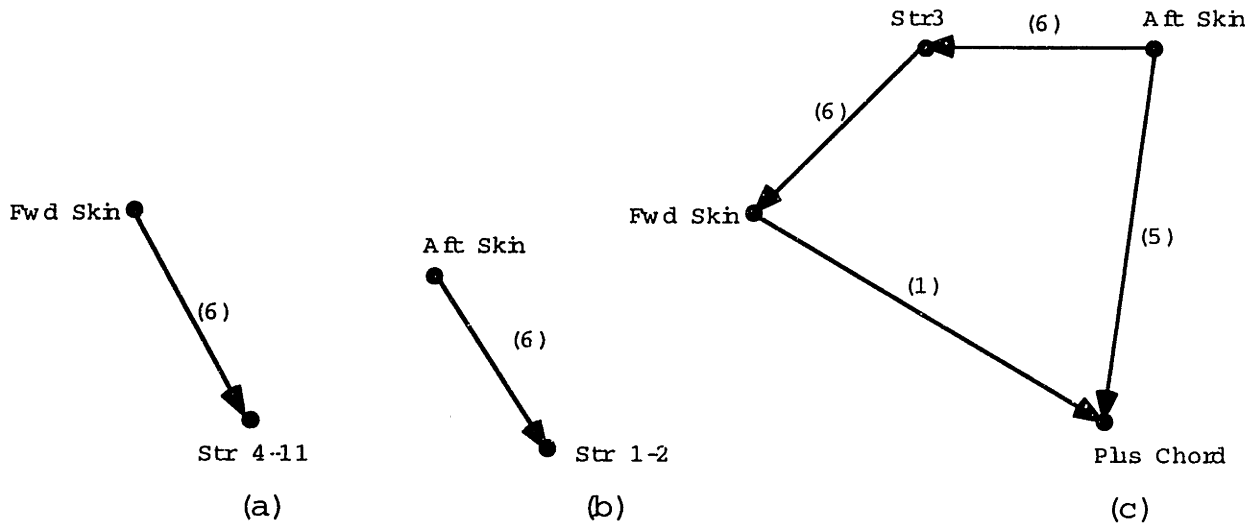

Figure 4-17: Fully defined subassemblies for the upper skin assembly permitted by the Constraint Rule for the DFC in Figure 4-15

There are thus two sets of assembly precedence constraints: Geometric precedence constraints and precedence constraints generated by the DFC. For a given assembly, each candidate DFC

design will generate a different set of precedence constraints. But the geometric precedence constraints remain the same for a given assembly unless there are major changes in mating features between parts. For the DFC shown in Figure 4-14, the precedence constraints imposed by the *Contact* and *Constraint* rules are shown in Figure 4-18: Note that the first three precedence constraints come from the *Contact* rule and the last two from the *Constraint* rule. $2 = 4$ and $4 = 2$ together signify that 2 and 4 have to be completed simultaneously.

4.4.5.2 Family of assembly sequences

The precedence constraints imposed by the DFC (by way of the contact and constraint rules) are applied in addition to the ones generated based on the geometric reasoning and interference analysis to generate a reduced set of assembly sequences. We call this set a DFC-family of assembly sequences for the given DFC. Assembly sequences in a family share some common properties since they satisfy the same locating scheme defined by the DFC. These properties, described in detail in section 4.5, are slightly different for type-1 and type-2 assemblies.

A typical assembly has a large number of assembly sequences and it is not practical to evaluate every possible assembly sequence. The DFC helps reduce the search space by creating families of assembly sequences that share common properties. As will be shown in the following sections, in type-1 assemblies a family forms an equivalence class of assembly sequences that will all have the same probability of delivering the KCs. In such cases only one sequence from the entire family need be evaluated. In type-2 assemblies, however, sequences within a family also need to be evaluated.

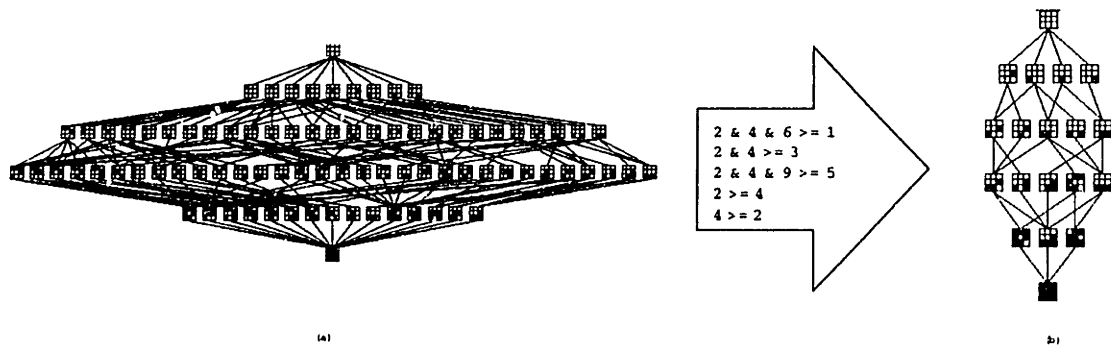

Figure 4-18: (a) complete set of assembly sequences (b) resulting family of sequences after applying constraints imposed by the DFC

The upper skin assembly shown in Figure 4-1 has 312 feasible assembly sequences, as shown in the assembly sequence graph in Figure 4-18(a). Every box in the graph represents a feasible assembly state and every path from the top to bottom of the graph represents a feasible assembly sequence (Baldwin, et al. 1991). At every level, one part is added or one process is performed on the assembly. After applying the constraints imposed by the DFC, the family consists of only 28 assembly sequences shown in Figure 4-18(b).

4.4.6 Modeling fixtures in assembly operations

Fixtures are an integral part of any assembly process. In automated type-1 assembly processes, they immobilize the base subassembly and present it to the part being assembled in the desired orientation. On the other hand, in type-2 assemblies fixtures define the location of one part with respect to another during assembly. Most assembly planning approaches in the past have modeled the assembly process strictly as adding parts and have not included fixtures in the modeling process.

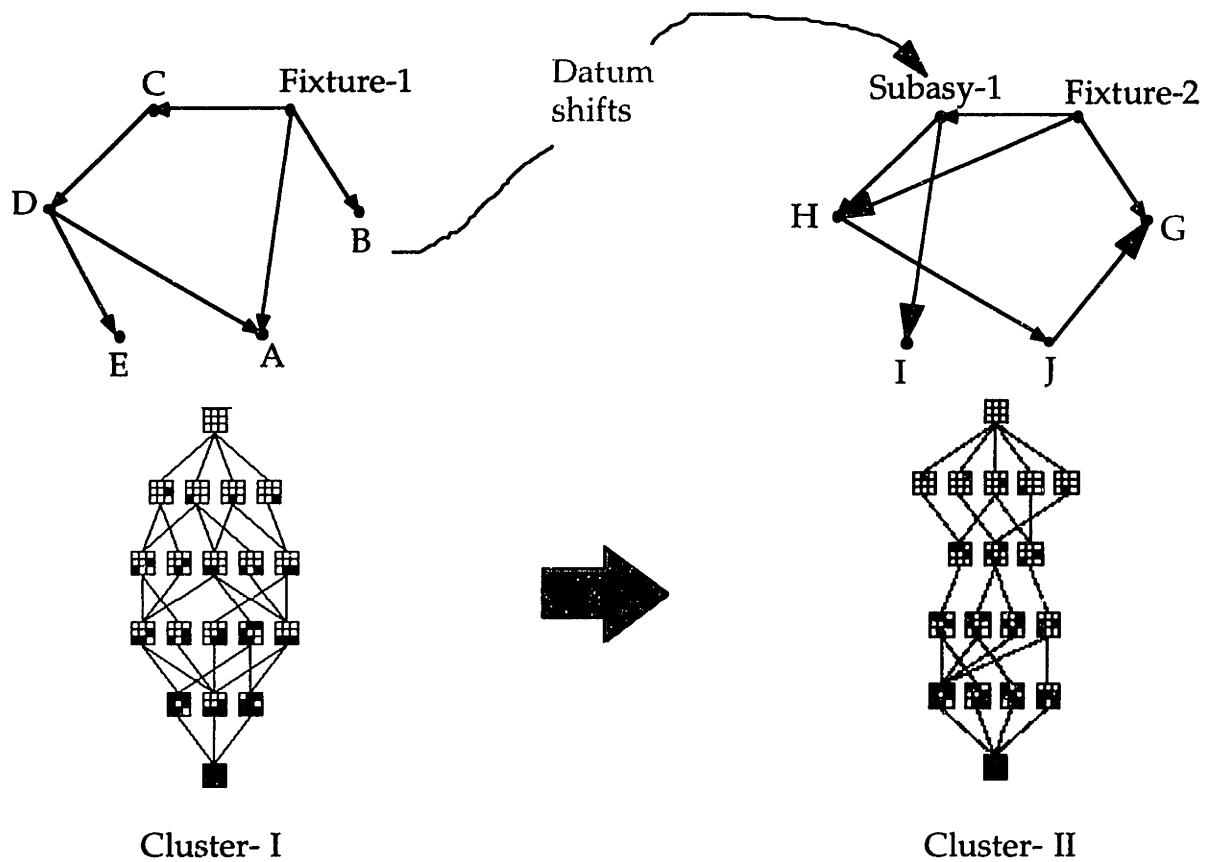

Figure 4-19: Modeling multiple assembly station assembly processes using DFC

We model assembly processes for type-2 assemblies and type-1 assemblies involving fixtures as series of clusters of assembly operations. Each cluster has one fixture and one or more associated DFCs that control all the assembly operations performed at the fixture, as shown in Figure 4-19. By modeling this way, we avoid the problem of fixtures coming in and going away whenever there is re-fixturing. It allows us to represent the fixture as a part and it forms the node with zero in-degree (base node) that roots the DFC and starts the assembly process. Precedence constraints (both geometric and DFC imposed) and resulting assembly sequences are generated for each cluster. During a re-fixturing, we must be aware of datum shifts that occur when the subassembly is located differently in one cluster compared to another. The entire assembly process is thus modeled using a piece-wise continuous chain formed by tracing the DFCs through one cluster along the datum shift line and into the next cluster. This chain determines how the assembly process in multiple assembly stations delivers the KCs and is an input to tolerance analysis. For the horizontal stabilizer assembly under discussion, DFCs for multiple assembly stations are illustrated in Figure 4-9 and Figure 4-11. We have also employed this procedure to study KC

delivery on 777 fuselage assembly sections that spanned five assembly stations and two organizations suggesting that the procedure can be scaled up to address industrial strength problems. A detailed explanation of the analysis performed is beyond the scope of this thesis.

4.4.7 Summary of DFC properties

The properties of the DFC and the constraints it imposes on the assembly process can be used as a monitoring tool to verify the consistency of a design and choice of assembly procedures. The following table summarizes the design rules imposed by the DFC:

Rule	Description
:	No loops or cycles permitted in a DFC
:	DoFs constrained by all incoming arcs to any node should add up to six : unless designed freedom
:	Incoming DoFs to a node should cover all the six coordinates: $x,y,z, \theta_x, \theta_y, \theta_z$
:	DFC is a graph of mates only
	In a DFC there is only one root node with only outgoing arcs. This node is either the fixture or a base part.
	Avoid long chains
	Avoid KC conflicts. When KCs conflict, they should be prioritized and higher priority should have mates with tighter tolerances
	In type-1 assemblies, every part must have at least one mate with at least one other part in the assembly.
	In type-2 assemblies, parts can have only contacts with other parts in the assembly. In such cases parts have mates with fixtures.
	Subassemblies with only contacts between parts are not permitted.
	Subassemblies with incompletely located parts are not permitted
	If the assembly process is performed in multiple assembly stations, each assembly station has a associated DFC.
	In assembly operations carried out in multiple assembly stations, guard against datum shifts.

Table 4-1: Design rules imposed by the DFC that can be used to verify designs

4.5 Evaluating alternate DFCs

A DFC highly constrains both assembly design and process. The design of mating features at part interfaces, tolerances on individual features and subassembly configurations are limited by which joints are mates and which ones are contacts in the DFC. The locating scheme, tolerance chains for the KCs, family of permissible assembly sequences and quality of resulting KCs are

also determined by the design of the DFC. Hence it is essential to develop analysis tools to evaluate and compare alternate DFCs. Some of the analysis can be qualitative, as there is no such thing as an optimal DFC or optimal assembly sequence. Different DFCs can be preferred under different operating conditions. Some of these analysis tools will be described below:

4.5.1 Decomposition and subassembly analysis

The decomposition of the assembly into subassemblies and the design of the DFC is related, as described in Section 4.4.3. The subassemblies deliver segments of KC chains and can be used as indicators to monitor the status of KCs during the assembly process. The percentage error contributed by individual subassemblies can be used for error budgeting and tolerance allocation purposes. Some subassemblies are more desirable than others in making these observations. For example, subassemblies where the status of the KCs is not predictable until the last few assembly operations can be undesirable for this reason. Since different DFCs will result in different permissible sets of subassemblies, relative desirability of subassemblies can be used as a metric to evaluate alternate DFCs.

4.5.2 Variation propagation analysis

An important metric used to choose between alternate designs and assembly sequences is the variation associated with the final assembly KCs accumulated from individual part and fixture variations, assembly errors, etc. The goodness of a locating scheme imposed by a DFC is evaluated by performing variation propagation analysis on families of assembly sequences, instead of individual assembly sequences. Since the designer defines explicitly the relationships between different parts while constructing a DFC, the DFC has all the information needed to perform any kind of variation propagation analysis. Traversing the DFC between the nodes (parts) of interest can readily derive the tolerance chains for any KC. The DFC is an acyclic graph and all the paths between any two nodes collectively define the tolerance chain between the two nodes. Hence, there is a unique tolerance chain in the DFC for every KC. A graph similar to the DFC can be constructed at a part level to determine all the datums within each node (part) that this tolerance chain will pass through. The extent to which these nodes are broken down into lower level graphs depends on the stage of the design process and level of detail desired. Further down the design cycle as designs become more definite, tolerance chains can be constructed to higher levels of detail.

4.5.2.1 Types of variation propagation problems in assemblies

We have identified four types of variation propagation problems that need to be addressed during assembly design and planning. The four classes of problems are defined as follows:

Class 1: Analysis of final assembly configuration: This is the most common type of variation propagation problem addressed by research efforts in the past and is usually applied to Type-1 assemblies. A typical approach includes constructing a CAD model of the assembly and representation of mating feature relationships between parts using a suitable data structure. The user then identifies a sum dimension, and a tolerance chain for the sum dimension is created either manually or automatically by a computer algorithm. Statistical analysis is then performed on this sum dimension, and the effect of variations in individual part dimensions on the final sum dimension is predicted. The issue here is to determine if the individual part tolerances are tight enough to meet final assembly tolerances. Typically assembly sequence and fixtures do not enter into this type of analysis.

Class 2: Type-1 assemblability problem: This is a problem that occurs at intermediate stages of assembly where interference due to accumulated variation leads to the failure of an assembly operation. Such problems are typically involved in type-1 assemblies. To predict such problems, at every assembly operation a closed loop chain is constructed that passes through coordinate frames on parts already assembled, the part being assembled, tooling used to grip the part being assembled and finally the fixture used to support parts already assembled. Fixtures and assembly sequence are an integral part of this type of analysis. The result is the ability to predict statistically the net lateral and angular error in the part/subassembly already in the assembly and the next part about to be added. As a result, the likelihood of successful assembly can be calculated.

Class 3: Type-2 variation propagation problem: In type-2 assemblies, it is possible to make in-process adjustments during assembly and hence re-define the distribution of variation. Here tolerance chains pass through fixtures that provide location for some or all parts of the assembly. The objective here is to develop a variation propagation algorithm that will determine the resulting variation distribution of assembly dimensions, given a set of variation

absorption sites. Another challenge is to design these variation absorption sites to control variation along only the directions of interest. Choice of the locating scheme and assembly sequence has a profound effect in these types of analyses.

Class 4: Selective assembly problem: This is a hybrid situation of type-1 and type-2 problems. Here during assembly a specific part (shim) may be selectively chosen from a bin of parts (shims) in order to absorb the effects of variation accumulated until that assembly operation. This can happen in both type-1 and type-2 assemblies and hence is a special case.

We call the first two classes of assembly problems **passive** assembly problems because the assembly process has no control over the resulting variation distribution of the assembly dimensions. However, this is not the case with type-2 and selective assembly problems and they are hence called **active** assembly problems. These problems are illustrated in Figure 4-20.

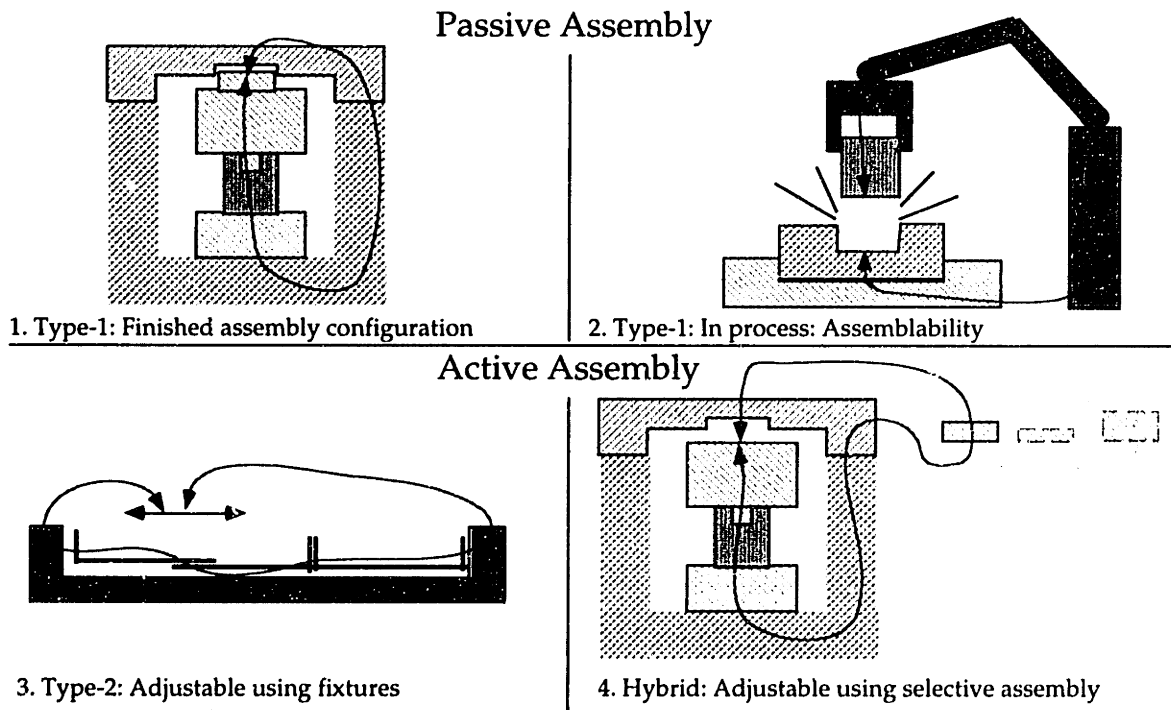

Figure 4-20: Different types of variation propagation problems in assemblies (The double-headed arrow in each illustration is the DFC)

Current variation propagation approaches are limited in scope and address only one or at most two of these problems at a time. As a part of this research we have developed algorithms that can

address the broad range of variation problems in assembly using a unified modeling approach. The development of the model is presented in Chapter 4 and the application of these algorithms to model variation propagation and control is presented in Chapter 5.

4.5.2.2 Assemblability analysis

In type-1 assemblies, all parts come to the assembly stations in their final form and the assembly process merely puts them together. Each new part contributes more variation to the assembly. A frequent problem is not being able to assemble a part due to interference caused by accumulated variation, especially in the case of automated assembly. For example, the interference could be caused due to limits imposed by part mating conditions: wedging and jamming (Nevins, et al. 1989). Hence an assemblability check needs to be performed at each assembly operation to determine the success or failure of an assembly operation.

At each assembly operation, a closed loop tolerance chain is completed that passes through the fixture locating the subassembly, the subassembly on the fixture, the part being assembled, the tool gripping the part being assembled and finally back to the fixture. This tolerance chain termed as an “in-process assemblability tolerance chain” can be derived directly by tracing the mates in the DFC. In addition there can be other parallel chains being completed by an assembly operation. In such cases, these other parallel chains establish contacts and hence can be seen in the liaison diagram and not the DFC. The contacts must have sufficient clearances to permit assembly after the mates have been established. Tolerance analysis using any standard tolerance analysis system can be performed on this assembly tolerance chain to determine if the assembly operation will fail or succeed. This problem is described in detail in (Whitney, et al. 1994).

By working with a family of sequences, we restrict our analysis to subassembly configurations that are defined by mates present in the controlling DFC. Each family of assembly sequences forms an equivalence class of sequences that share a common locating scheme. Hence, each assembly sequence in the family of assembly sequences builds different elements of the same in-process assemblability tolerance chain. If any one assembly sequence fails to perform an assembly operation all the assembly sequences in the family will also fail to perform that particular assembly operation. These sequences will however fail at different assembly stations

depending upon when the particular operation is performed. Hence it is not necessary to examine every assembly sequence in a family of assembly sequences. It is sufficient to analyze any one assembly sequence from the family and if this sequence fails to perform any particular assembly operation, the entire family of sequences can be rejected. On the other hand, if this sequence successfully completes all assembly operations, every sequence in the family of assembly sequences will also complete all assembly operations successfully. For a type-1 assembly, the state of the in-process assemblability tolerance chain at a particular assembly station is independent of the path taken to arrive at that assembly state. If all assembly operations are successful, all the KCs for the assembly will be delivered regardless of the assembly sequence.

4.5.2.3 Type-2 variation propagation analysis

In type-2 assemblies, there is freedom to consciously select at least some of the features that define *mates* and *contacts*. The contact features can be designed to selectively absorb variation along certain directions and propagate certain others (for example, slip planes, peg-slot joints, designed gaps, etc.)(Mantripragada, et al. 1997). The ability to make in-process adjustments in type-2 assemblies is due to the presence of *mates* that are completed by fixtures and *contacts* that allow for variation absorption in the assembly. The amount of variation tuned out and the directions along which the variation can be tuned out are determined by the type of the contact feature. Rigid body motion between parts based on in-process measurements is possible along selected directions. Variations accumulated in *mates* between two parts cannot be tuned out directly. However it may be possible to tune out their effects on final assembly dimensions when some *contacts* are established in downstream assembly operations.

Although we have stated above that mates carry dimensional transfer information between parts while contacts carry none, it is true in general that joints can carry dimensional information along some directions while carrying none along others. Thus joints, in general, can have some of the properties of both mates and contacts. To simplify matters and to permit us to study variation absorption, this thesis considers any absorption zone in a joint as a contact.

This simplification permits us to describe a way to definitively identify all the contacts in a liaison diagram by inspection, by comparing it to the DFC that lies on top of it. We assume that

the DFC, via mates to other parts or mates to fixtures definitively locates every part in the assembly (within the limits of variation). This can occur in two ways: 1) a single arc carrying 6 DOF points to the part; 2) two or more arcs whose DOF add to 6 point to the part. In case 2), these DFC arcs are members of an acyclic loop that coincides with a loop in the liaison diagram. Since all the members of this loop are mates, there are no contacts in this loop. In case 1), the single arc cannot be a contact because the part at the end will not, by definition, be definitively located. However, case 1) can include situations where the underlying liaison diagram contains a loop, of which one or more arcs will by definition not be elements of the DFC. These extra arcs are contacts (otherwise the parts they connect would be over-constrained since the existing mates' DOF already add to 6). Therefore, contacts will be found exclusively in liaison diagram loops that do not correspond to DFC loops. Therefore, to identify where and when to absorb variation, one needs to identify and monitor, during an assembly sequence, the closure of specific, easily identified loops in the liaison diagram.

This concept is illustrated in Figure 4-21. As can be seen in the figure, all the parts have mates with the fixture and contacts between each other. The fixture forms four non-redundant loops with the parts. The contacts are shown as a dashed line in the DFC for illustration purposes.

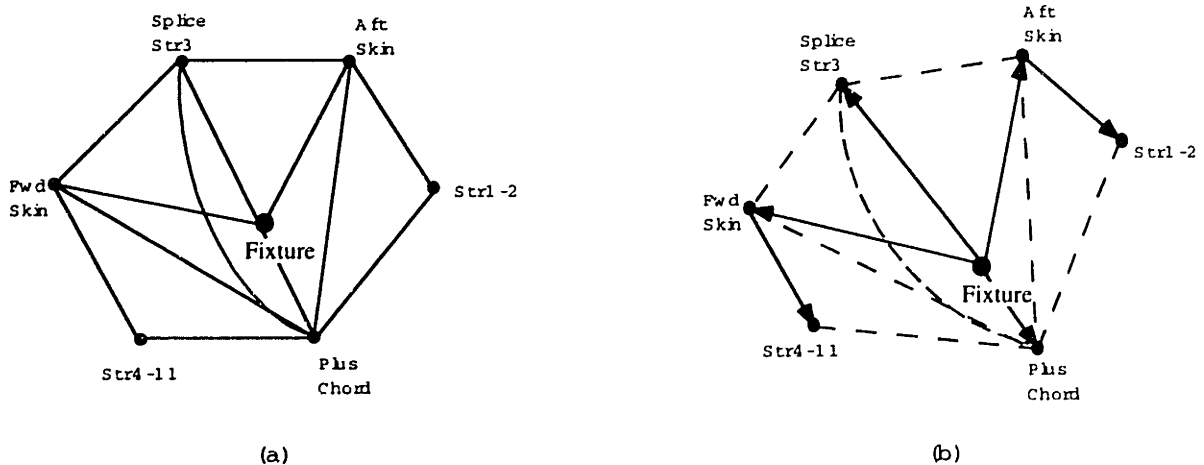

Figure 4-21: (a) liaison diagram showing multiple loops in the assembly (b) DFC for the assembly; all contacts are shown as dashed lines

Variation propagation algorithms that can determine resulting variation distribution of KCs in the presence of in-process adjustments have been developed to evaluate different assembly

sequences (Mantripragada, et al. 1997, Mantripragada, et al. 1997). To simplify matters and to permit us to study variation absorption, these algorithms consider any absorption zone in a joint as a contact. This simplification permits us to describe a way to definitively identify all the contacts in a liaison diagram by inspection, by comparing it to the DFC that lies on top of it. Different assembly sequences will establish contacts at different stages of the assembly process and hence will have different resulting variation distributions. Thus for type-2 assemblies, the state of the tolerance chains at any assembly station is a function of the path taken to arrive at that station. We call this property of type-2 assemblies as *path dependency*.

4.5.3 Assembly sequence analysis

Evaluation of assembly sequences within a family resulting by applying DFC constraints can also be done using traditional evaluation methods. The most basic is inspecting different assembly states and transitions and interactively deleting the undesirable ones (Baldwin, et al. 1991). The editing could be based on conditions such as: deletion of moves where a particular set of liaisons are made, specification that a particular move must immediately precede another, subassemblies hard to assemble due to accessibility problems, etc. These editing techniques quickly reduce the number of sequences to a handful that can be subject to more detailed analysis.

4.6 Analysis of Boeing 777 Aircraft fuselage assembly

The theories of the DFC have been successfully implemented to model and study the assembly of Boeing 777 aircraft fuselage structures. DFCs were constructed from observing existing assembly practices, which is not the best application of a DFC. The desired application of a tool such as the DFC is to be able to foresee the effects of choosing different assembly procedures, indexing methods, explore different scenarios and rationally conclude with the design of a product and process that work. Since this was an existing assembly under production, it was not possible to take such an approach to analyzing this assembly.

Top-level airplane KCs were first identified and were progressively flowed down to sub-assemblies and individual parts. The DFC was used as the primary tool to capture this flowdown and represent explicitly the relationships that need to be established during assembly to deliver

the desired KCs. Several organizational boundaries and assembly stations within each organization were spanned by these DFCs for each KC. The exercise illustrated the fact that DFCs can also be used to capture functional supply chain relationships for assemblies and identify clearly the segments of each KC chain that each organization was responsible for. Two main aspects of these assemblies were critiqued using the DFC:

The tooling and fixturing plans used to locate parts and subassemblies. These plans were critiqued with respect to the KCs that the assembly had to deliver at different stages of the assembly process. The plans were evaluated to see if the dimensioning and locating schemes imposed were consistent with the datum relationships that need to be controlled for successful KC delivery.

The assembly procedures at various assembly stations. Assembly procedures were evaluated at various assembly stations at different supplier locations for consistency with the tooling plans. This involved identifying the mates and contacts in the assembly, the assembly sequence, monitoring how each part and sub-assembly was being located, datum shifts between assembly stations, and relations between part fabrication datums and assembly datums.

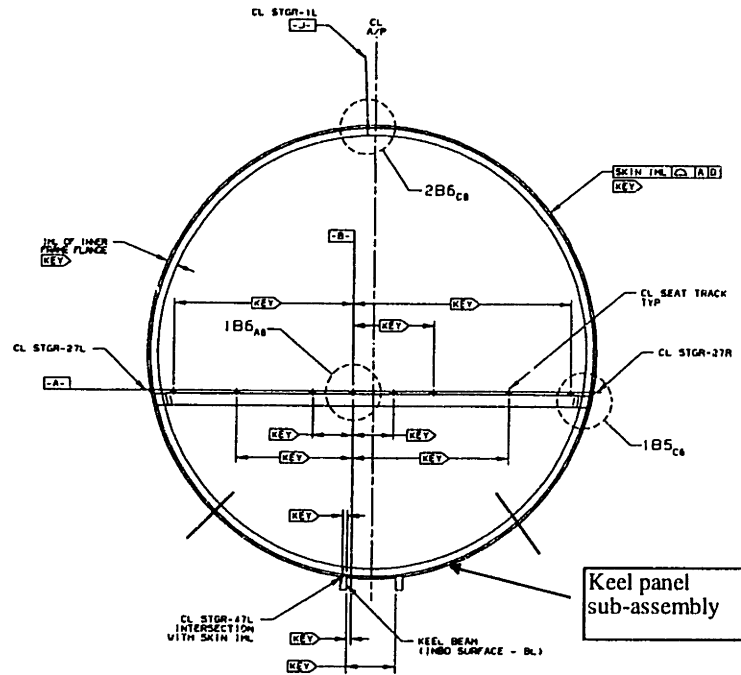

Figure 4-22: Cross-section of an airplane fuselage section showing the keel panel sub-assembly

Analysis performed on the keel panel sub-assembly that forms the lower portion of an aircraft fuselage section is used here as an example to illustrate the type of analysis performed. A cross-section of an airplane fuselage section is shown in Figure 4-22. Keel panel sub-assembly is marked on the figure.

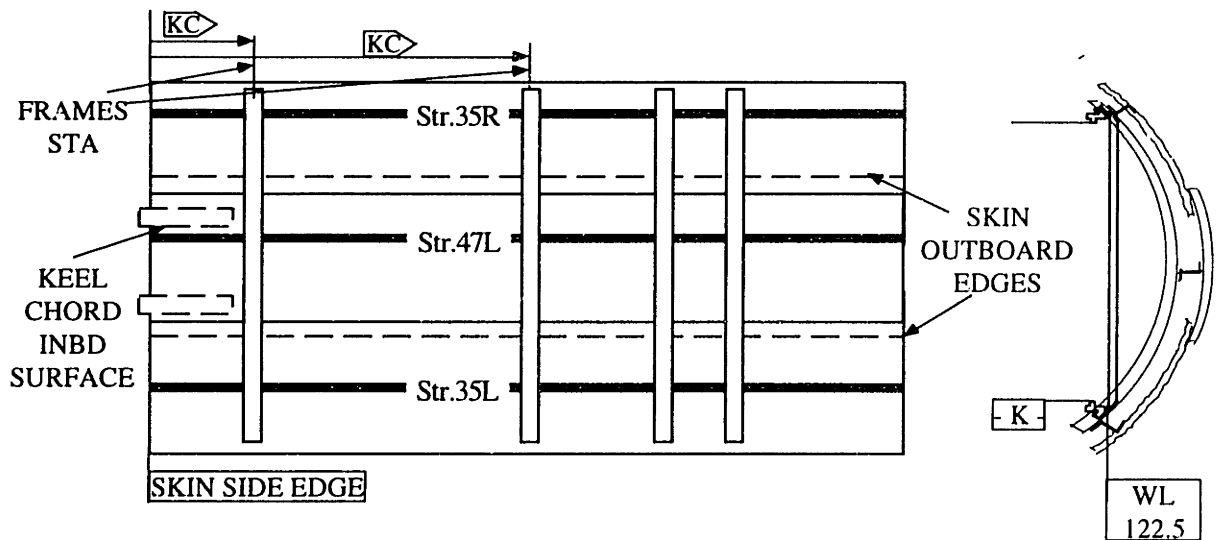
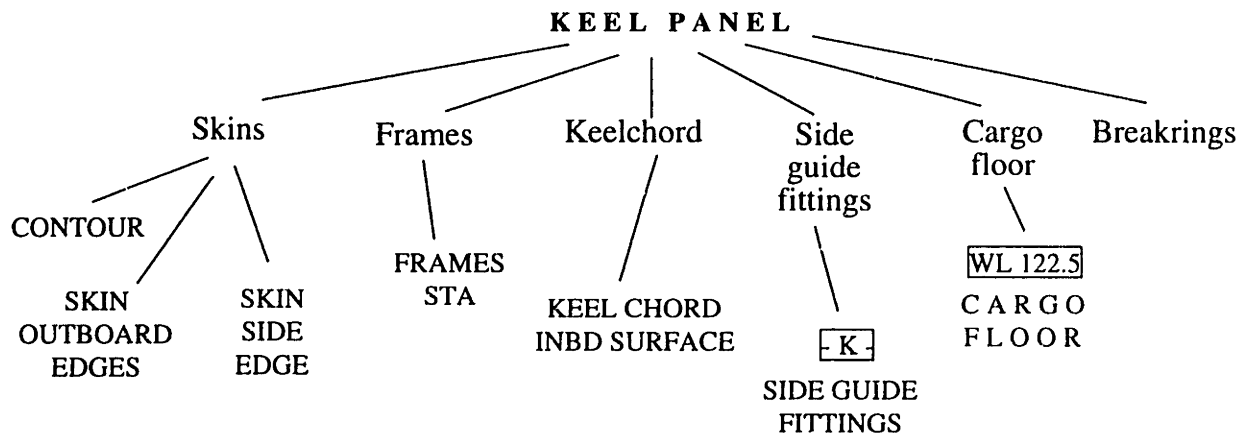

Figure 4-23: Important datums on the keel panel

The keel panel assembly consists of six major parts that are of interest in studying the flowdown of the KCs. These are the skin panels, frames, breakrings, the keel chord, the cargo floor assembly and the side guide fittings. A schematic of the keel panel sub-assembly and the important datums associated with these parts are shown in Figure 4-23.

We now look at how datum relationships are achieved by the AS-IS assembly procedures employed to build the keel panel assembly using the DFC.

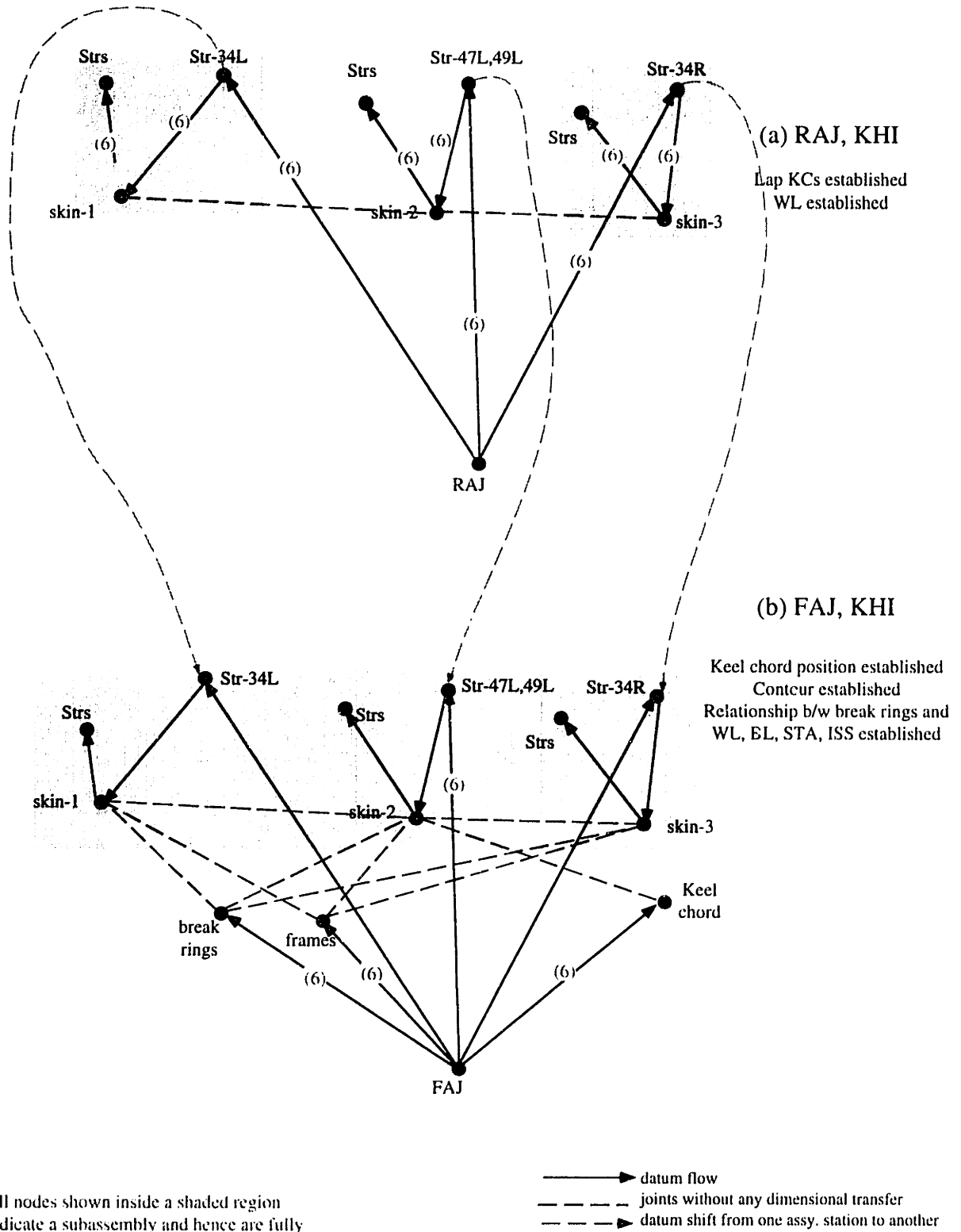
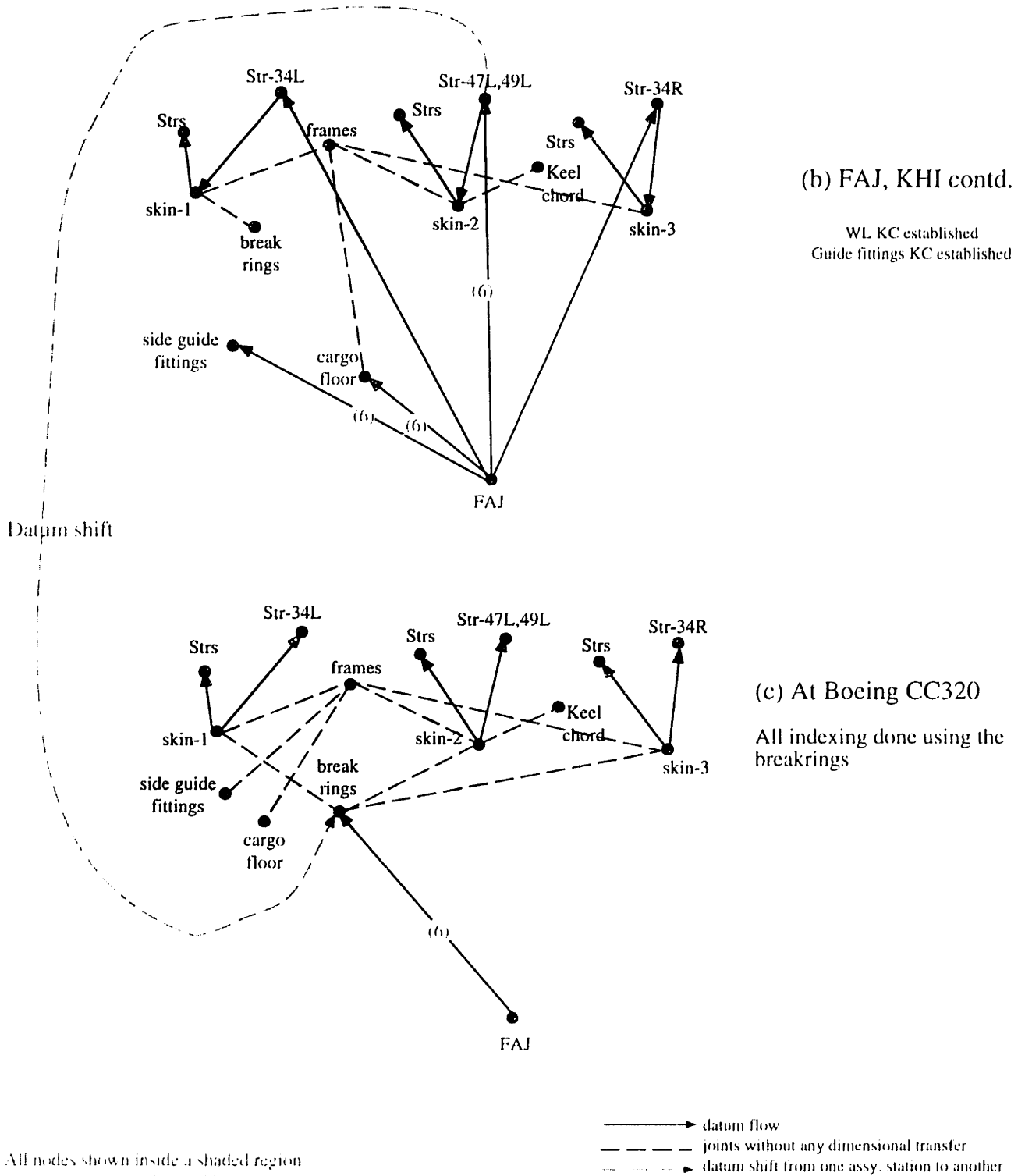

Figure 4-24: Datum flow chains for the keel panel assembly



All nodes shown inside a shaded region indicate a subassembly and hence are fully constrained with respect to each other

Figure 4-24(continued): Datum flow chains for the keel panel assembly

Figure 4-24 shows the DFCs for the keel panel assembly process. Figure 4-24(a) shows the DFC for the assembly process performed at the assembly fixture (called the RAJ) at a supplier site.

Here the three skin panels are indexed off stringers 34L, 47L, and 34R respectively and riveted to each other. The amount of overlap between the skin panels is fixed by this first operation of the assembly process. The skin stringer assembly is then transferred to and re-indexed off the assembly fixture FAJ. As shown in Figure 4-24(b) the same indexes are used for location. At the FAJ, the keel chord, frames, breakrings, side guide fittings and the cargo floor are assembled to the skin panel assembly. All of these parts are located with respect to the FAJ during assembly. Hence all the datums identified in the previous section of the report are defined relative to the FAJ at KHI. There are no measurements made between any two datums on the keel panel assembly (no part-to-part) measurements. A datum shift is observed in the indexing procedures between the FAJ at KHI and the FAJ at CC 320. As shown in Figure 4-24(b) and (c), the datum shift occurred from Stringers. 47L-49L at KHI to the breakrings at CC 320.

Similar DFCs were constructed for every sub-assembly in the fuselage section. The DFC thus provided for a more complete tool to monitor the design and assembly process than any existing procedures at Boeing. Some of the terminology and methods of the DFC are currently being used at Boeing to diagnose and study assembly fit-up problems.

4.7 Summary

This chapter presented a top-down design approach to link logical design of assembly layouts with KC flowdown, assembly sequence and tolerance analyses and create assembly sketchers and analyzers capable of analyzing assembly processes before detailed geometry has been designed. Two types of assemblies were identified: Type-1 where the assembly process puts parts together at their pre-fabricated mating features and Type-2 where the assembly process can incorporate in-process adjustments to redistribute variation. The DFC permits layout designers to think through possible hierarchies of dimensional datums and then to design chains of these datums to control how parts are located with respect to each other. It is useful for selecting dimensional datum strategies and assembly processes that are best able to meet final assembly requirements. The DFC emphasizes the need to distinguish the joints that define dimensional constraint from the ones that are redundant location wise and merely provide support once the parts are located. This chapter described the role of the DFC in subassembly design, assembly modeling and planning. Algorithms to translate the hierarchy imposed by a DFC into assembly

precedence constraints were developed and presented in this chapter. These algorithms were used to generate families of assembly sequences that share the same locating scheme. This reduces the design space to a small set of workable assembly sequences that are consistent with part datuming scheme. In type-1 assemblies, since there are no in-process adjustments permitted during assembly, all sequences in a family have the same probability of delivering the key characteristics. However, in type-2 assemblies these sequences have different probabilities of success due to the ability to make in process adjustments during assembly. Four classes of variation problems were identified for these two types of assemblies. The DFC provides for a common environment to address a broad range of assembly planning issues for both types of assemblies.

The following chapters describe a common modeling framework to analyze the four classes of variation problems. These models enable the designer to consider the effect of different locating schemes and mating features while still at the conceptual stage. It is our intention to demonstrate the DFC idea in a CAD environment. For this purpose, a DFC editor is being created to interactively define DFCs, visualize them on the computer screen, and connect them to required analyses such as tolerance buildup and assembly sequencing. Chapter 6 describes the structure of the proposed assembly oriented design framework and describes some of the software tools developed in detail.

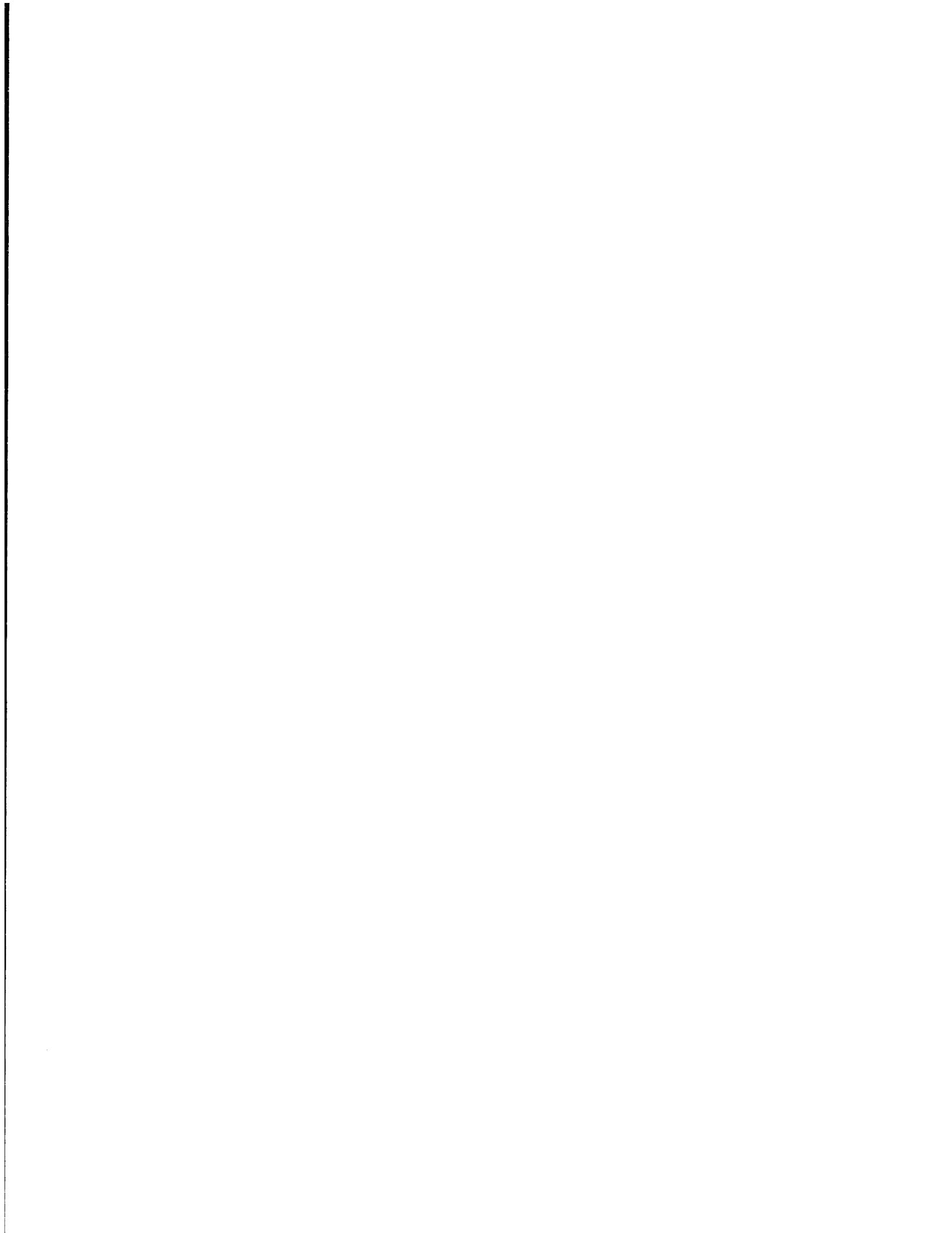

“As far as the laws of mathematics refer to reality, they are not certain, and as far as they are certain, they do not refer to reality.”

- Albert Einstein

5.

State Transition Models

5.1 Overview

This chapter presents a new approach to model the propagation and control of variation in different kinds of assemblies. The method enables the designer to consider the effect of different locating schemes and assembly sequences on the final assembly quality while still at the conceptual stage. The four classes of variation problems described in Section 3.6.2 are addressed using this common approach. Sections 5.2 through 5.5 introduce the Discrete Event State Transition Models for modeling type-1 and type-2 assembly processes and describe the underlying mathematical derivations. Section 5.6 summarizes the modeling approach and presents directions for future research.

5.2 Modeling Type-1 assemblies

Most complex assemblies consist of many individual sub-assemblies and parts made by different suppliers at different locations. Variations are inherent to any manufacturing and assembly process and cause small deviations in parts from nominal geometry. These deviations propagate and accumulate as parts are assembled and can quickly drive assembly dimensions out of

specification. Modeling the assembly process and identifying all the elements contributing to errors is a pre-requisite to performing any kind of variation propagation analysis on assemblies.

If we describe the total variation accumulated in an assembly along a KC chain by the position and orientation of a frame (the last coordinate frame so far) in space, the resulting error distribution is represented by two probability density ellipsoids (one for translational errors and one for rotational errors, assuming normal distribution of the contributing errors, (Whitney, et al. 1994)) with highest density at the nominal position of the frame. We shall call these ellipsoids *variation ellipsoids*.

In type-1 assemblies, if these ellipsoids are too large, it may be difficult or even impossible to assemble the parts. We define *assemblability* as a measure to quantify the probability of successfully assembling a part to the rest of the assembly at any stage of the assembly process. This probability is determined by the size of these ellipsoids and the conditions imposed by part mating theory(Whitney 1982), (Whitney, et al. 1994).

The state transition model described below permits us to:

Develop a tri-variate normal density function for the location of the N^{th} coordinate frame at the end of the KC chain

Describe the location, orientation and axes lengths of the two probability density ellipsoids: one for linear or translation errors and other for rotational or angular errors at the N^{th} frame.

5.3 State model of Type-1 assembly process

The state of an assembly at any assembly station is described by a 6×1 vector $\tilde{X}(k)$. $\tilde{X}(k)$ describes the total deviation in the position and orientation of a coordinate frame on a mating feature on the k^{th} part along a KC chain, measured from its nominal or zero mean location, expressed in the coordinate frame of the part at the base of the chain. These errors are assumed small compared to the size of the parts in the assembly. $\tilde{X}(k)$ is given as follows:

$$\tilde{X}(k) = \begin{bmatrix} dp_k \\ d\theta_k \end{bmatrix} = \begin{bmatrix} dp_k^x \\ dp_k^y \\ dp_k^z \\ d\theta_k^x \\ d\theta_k^y \\ d\theta_k^z \end{bmatrix}$$

where dp_k is the first order differential error in the Cartesian position of the k^{th} frame and $d\theta_k$ the corresponding error in orientation.

If we define

$\tilde{w}(k)$: 6×1 vector describing the variation associated with the part being assembled at the k^{th} assembly station, expressed in local part coordinates

$\tilde{X}(k+1)$: 6×1 vector describing the total variation accumulated after the k^{th} assembly station, defined and measured in the base coordinate frame for the KC chain. This becomes the input to the $(k+1)^{\text{th}}$ assembly station

then, we will show that the state transition equation for the assembly process can be written as:

$$\tilde{X}(k+1) = A(k)\tilde{X}(k) + F(k)\tilde{w}(k) \quad (5-1)$$

where

$A(k)$: Identity matrix

$F(k)$: 6×6 matrix that transforms the variation associated with the incoming part at the k^{th} assembly station from part k 's coordinate frame to the base coordinate frame of the KC chain.

The propagation of variation in 3-D space is treated as propagation of errors during transformations of Cartesian frames. Cartesian frames are attached to mating features on every part. There exist six degrees of freedom for dimensional transformations of frames or their small errors. The model assumes that parts are assembled by joining mating features to each other [DeFazio, 1990 #60]. The relative positions of these features within each part and between

assembled parts are described using 4x4 homogeneous transforms. The net tolerances between the features are described by multiplying the nominal transforms by adjustment transforms, whose calculations can be found in (Whitney, et al. 1994). As parts are added to the assembly, the position and orientation of the last part is calculated by multiplying all of these adjusted transforms together. The chain passing through these mating features is the KC chain and is determined by the DFC. The actual situation compared with the nominal is illustrated in Figure 5-1.

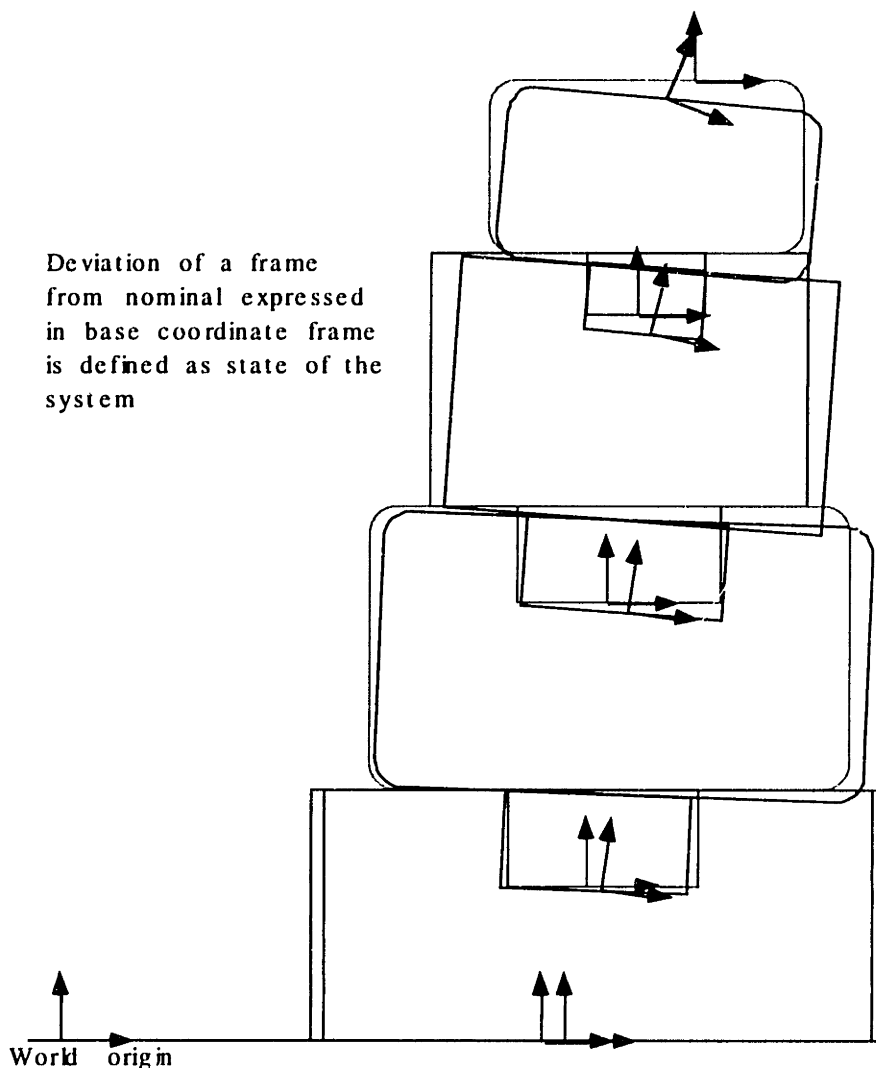

Figure 5-1: Example build up of parts under influence of variation. The shaded lines indicate nominal and solid lines indicate true location of the parts. The deviation of the coordinate frame on a mating feature on the kth part from nominal location expressed in base coordinate frame is the state of the system $\tilde{X}(k)$

A statistical statement of the last part's location is calculated using a closed-form algorithm described below. Most of the calculations are based on the work of (Veitschegger, et al. 1986) in the domain of robot uncertainty prediction. Their work uses the common method of 4x4 homogeneous transformation matrices to represent the relative location of robot joints, and uses the variant transforms to predict the effect of individual joint and link errors on the position and orientation of the end point. (Veitschegger, et al. 1986) showed that the differential translation vector dp_N and the differential rotation vector $d\theta_N$ associated with the position of the N^{th} frame defined with respect to base coordinates, can be computed as follows:

$$\begin{aligned} dp_N &= \sum_{i=1}^N [R_{i-1} dp_i + p_{i-1} \times \{R_{i-1} d\theta_i\}] \\ d\theta_N &= \sum_{i=1}^N R_{i-1} d\theta_i \end{aligned} \quad (5-2)$$

where R_{i-1} is a 3×3 rotation matrix and p_{i-1} is a 3×1 translation vector, both obtained from the A_{i-1} transform defined as the transformation between $i-1$ and i^{th} frame as follows:

$$\begin{aligned} [A_i] &= [A_i]_{trans} [A_i]_{rot} \\ [A_i]_{rot} &= [A_i]_{rotx} [A_i]_{roty} [A_i]_{rotz} \end{aligned} ,$$

where

$$\begin{aligned} [A_i]_{trans} &= \begin{bmatrix} 1 & 0 & 0 & X_i \\ 0 & 1 & 0 & Y_i \\ 0 & 0 & 1 & Z_i \\ 0 & 0 & 0 & 1 \end{bmatrix} & [A_i]_{rotx} &= \begin{bmatrix} 1 & 0 & 0 & 0 \\ 0 & \cos \theta_{xi} & -\sin \theta_{xi} & 0 \\ 0 & \sin \theta_{xi} & \cos \theta_{xi} & 0 \\ 0 & 0 & 0 & 1 \end{bmatrix} \\ [A_i]_{roty} &= \begin{bmatrix} \cos \theta_{yi} & 0 & \sin \theta_{yi} & 0 \\ 0 & 1 & 0 & 0 \\ -\sin \theta_{yi} & 0 & \cos \theta_{yi} & 0 \\ 0 & 0 & 0 & 1 \end{bmatrix} & [A_i]_{rotz} &= \begin{bmatrix} \cos \theta_{zi} & -\sin \theta_{zi} & 0 & 0 \\ \sin \theta_{zi} & \cos \theta_{zi} & 0 & 0 \\ 0 & 0 & 1 & 0 \\ 0 & 0 & 0 & 1 \end{bmatrix} \end{aligned}$$

(5-3)

and the general form of A_i is given as:

$$A_i = \begin{bmatrix} R_i & p_i \\ 0 & 1 \end{bmatrix}$$

The dP_N and $d\theta_N$ vectors can be represented in the following matrix form:

$$\tilde{X}(N) = \begin{bmatrix} dp_N \\ d\theta_N \end{bmatrix} = \begin{bmatrix} W_1 \\ 0 \end{bmatrix} \Delta X + \begin{bmatrix} W_2 \\ 0 \end{bmatrix} \Delta Y + \begin{bmatrix} W_3 \\ 0 \end{bmatrix} \Delta Z + \begin{bmatrix} W_{10} \\ W_5 \end{bmatrix} \Delta\theta_x + \begin{bmatrix} W_{11} \\ W_7 \end{bmatrix} \Delta\theta_y + \begin{bmatrix} W_{12} \\ W_9 \end{bmatrix} \Delta\theta_z \quad (5-4)$$

where $\Delta X = [\Delta X_1, \Delta X_2, \dots, \Delta X_N]^T, \dots, \Delta\theta_z = [\Delta\theta_{z1}, \Delta\theta_{z2}, \dots, \Delta\theta_{zN}]^T$ are $N \times 1$ vectors of designer specified tolerances.

Equation (5-4) can be rewritten as:

$$\begin{bmatrix} dp_k^x \\ dp_k^y \\ dp_k^z \\ d\theta_k^x \\ d\theta_k^y \\ d\theta_k^z \end{bmatrix} = \begin{bmatrix} W_{(1,1),1} & W_{(1,1),2} & \cdot & \cdot & W_{(1,1),k} \\ W_{(1,2),1} & W_{(1,2),2} & \cdot & \cdot & W_{(1,2),k} \\ W_{(1,3),1} & W_{(1,3),2} & \cdot & \cdot & W_{(1,3),k} \\ 0 & 0 & 0 & 0 & 0 \\ 0 & 0 & 0 & 0 & 0 \\ 0 & 0 & 0 & 0 & 0 \end{bmatrix} \begin{bmatrix} \Delta X_1 \\ \Delta X_2 \\ \cdot \\ \cdot \\ \Delta X_k \end{bmatrix} + \dots + \begin{bmatrix} W_{(12,1),1} & W_{(12,1),2} & \cdot & \cdot & W_{(12,1),k} \\ W_{(12,2),1} & W_{(12,2),2} & \cdot & \cdot & W_{(12,2),k} \\ W_{(12,3),1} & W_{(12,3),2} & \cdot & \cdot & W_{(12,3),k} \\ W_{(9,1),1} & W_{(9,1),2} & \cdot & \cdot & W_{(9,1),k} \\ W_{(9,2),1} & W_{(9,2),2} & \cdot & \cdot & W_{(9,2),k} \\ W_{(9,3),1} & W_{(9,3),2} & \cdot & \cdot & W_{(9,3),k} \end{bmatrix} \begin{bmatrix} \Delta\theta_{z1} \\ \Delta\theta_{z2} \\ \cdot \\ \cdot \\ \Delta\theta_{zk} \end{bmatrix} \quad (5-5)$$

where

$$W_{li} \text{ (3} \times \text{1 vector)} = \begin{bmatrix} W_{(1,1),i} \\ W_{(1,2),i} \\ W_{(1,3),i} \end{bmatrix} \text{ and similarly the rest of the W vectors are defined in (Jastrzebski}$$

1991),

Equation.(5-5) can be rewritten as:

$$\begin{bmatrix} dp_k^x \\ dp_k^y \\ dp_k^z \\ d\theta_k^x \\ d\theta_k^y \\ d\theta_k^z \end{bmatrix} = \begin{bmatrix} dp_{k-1}^x \\ dp_{k-1}^y \\ dp_{k-1}^z \\ d\theta_{k-1}^x \\ d\theta_{k-1}^y \\ d\theta_{k-1}^z \end{bmatrix} + \begin{bmatrix} W_{(1,1),k} & W_{(2,1),k} & W_{(3,1),k} & W_{(10,1),k} & W_{(11,1),k} & W_{(12,1),k} \\ W_{(1,2),k} & W_{(2,2),k} & W_{(3,2),k} & W_{(10,2),k} & W_{(11,2),k} & W_{(12,2),k} \\ W_{(1,3),k} & W_{(2,3),k} & W_{(3,3),k} & W_{(10,3),k} & W_{(11,3),k} & W_{(12,3),k} \\ 0 & 0 & 0 & W_{(5,1),k} & W_{(7,1),k} & W_{(9,1),k} \\ 0 & 0 & 0 & W_{(5,2),k} & W_{(7,2),k} & W_{(9,2),k} \\ 0 & 0 & 0 & W_{(5,3),k} & W_{(7,3),k} & W_{(9,3),k} \end{bmatrix} \begin{bmatrix} \Delta X_k \\ \Delta Y_k \\ \Delta Z_k \\ \Delta\theta_{xk} \\ \Delta\theta_{yk} \\ \Delta\theta_{zk} \end{bmatrix}$$

(5-6)

Equation (5-6) relates the total accumulated variation after k frames with the total variation accumulated after $(k-1)$ frames and the variation associated with the k^{th} frame. Notice that both linear and angular errors influence final position error but only angular error affect the $d\theta_k$ vector. Comparing equation (5-6) with (5-1), we have

$$A(k) = I, F(k) = \begin{bmatrix} W_{(1,1),k} & W_{(2,1),k} & W_{(3,1),k} & W_{(10,1),k} & W_{(11,1),k} & W_{(12,1),k} \\ W_{(1,2),k} & W_{(2,2),k} & W_{(3,2),k} & W_{(10,2),k} & W_{(11,2),k} & W_{(12,2),k} \\ W_{(1,3),k} & W_{(2,3),k} & W_{(3,3),k} & W_{(10,3),k} & W_{(11,3),k} & W_{(12,3),k} \\ 0 & 0 & 0 & W_{(5,1),k} & W_{(7,1),k} & W_{(9,1),k} \\ 0 & 0 & 0 & W_{(5,2),k} & W_{(7,2),k} & W_{(9,2),k} \\ 0 & 0 & 0 & W_{(5,3),k} & W_{(7,3),k} & W_{(9,3),k} \end{bmatrix}$$

The above derivation is a special case where the KC chain grows monotonically only in one direction during assembly.

For a sequence of assembly operations in type-1 assemblies, Equation (5-6) can be schematically represented as follows in Figure 5-2:

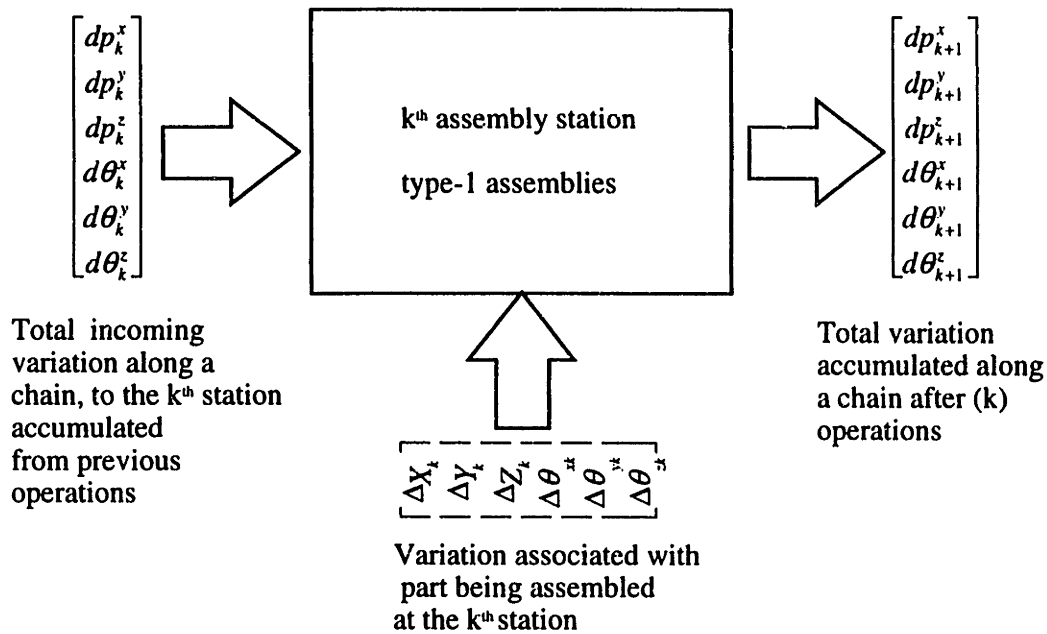

Figure 5-2: State transition model of a type-1 assembly

Hence the assembly process can be described as a linear discrete event process, where the state of the system is defined by the 6×1 error vector $\tilde{X}(k)$. The index k indicates the k^{th} assembled part along the KC chain. The chain is defined by the locating scheme imposed by the DFC for the assembly. The DFC also defines the constituents of the matrix $F(k)$, as this matrix defines how the k^{th} part is located with respect to the coordinate frame on the base part. $\tilde{w}(k)$ defines the variation associated with the mating features on the k^{th} part. These variabilities are associated with the fabrication of the part and are represented as designer specified tolerance ranges on the size and location of mating features with respect to the part's local coordinate frame.

Typically, a KC is a linear and/or angular dimension, and hence variation associated with a KC is a subset of $\tilde{X}(k)$. If we define $\tilde{y}(k)$ as the $r \times 1$ ($r \leq 6$) output vector defining the resulting variation associated with a KC, then the output equation can be written as:

$$\tilde{y}(k) = C(k)\tilde{X}(k)$$

where $C(k)$ is a $r \times 6$ output matrix of 1s and 0s, defining the values that we are interested in, for a particular KC.

Hence, from the above discussion, for a type-1 assembly process modeled as a discrete event linear time varying system, the state and output equation can be written as:

$$\begin{aligned}\tilde{X}(k+1) &= A(k)\tilde{X}(k) + F(k)\tilde{w}(k) \\ \tilde{y}(k) &= C(k)\tilde{X}(k)\end{aligned}\tag{5-7}$$

On the basis of the assumption that the error distributions $\tilde{w}(k)$ s are normally distributed random variables, the differential translation vector and the differential rotation vector after N parts have been added is a trivariate normal density functions with the following form, ref.(Veitschegger, et al. 1986)

$$\begin{aligned}f(dp_N) &= \frac{1}{(2\pi)^{3/2}|V_p|^{1/2}} \exp\left\{-0.5\left[(dp_N)^T V_p^{-1}(dp_N)\right]\right\} \\ f(d\theta_N) &= \frac{1}{(2\pi)^{3/2}|V_\theta|^{1/2}} \exp\left\{-0.5\left[(d\theta_N)^T V_\theta^{-1}(d\theta_N)\right]\right\}\end{aligned}\tag{5-8}$$

where V_p, V_θ are 3×3 covariance matrices of the dp_N translational vector and $d\theta_N$ rotational vector. These two probability density functions will give three dimensional error envelopes for translational and rotational errors of the final frame location.

5.4 Modeling Type-2 assemblies

Almost all the work in modeling variation in assemblies has concentrated on what we call type-1 assemblies. Different types of tolerance propagation algorithms, assembly sequence algorithms, assembly planning approaches, etc. have been proposed and developed for type-1 kind of assemblies and have been generalized to be applicable to all kinds of assemblies. However, we claim that type-2 assemblies are inherently different from type-1 assemblies and have to be modeled separately. Not much attention has been given in the past to model type-2 kind of assemblies. Hu et al have modeled different kind of joint configurations and their variation characteristics in sheet metal assemblies (Liu, et al. 1996).

As described in Chapter 5, contacts can be used as potential variation absorption sites in type-2 assemblies. To study the propagation of variation in the presence of such absorption sites, we need include the effect of adjustments in our state model. Variation absorption sites are modeled as control inputs that can be chosen in response to the variation distribution of the parts involved. The following section describes the derivation of a model to study variation propagation in type-2 assemblies.

5.5 State model of Type-2 assembly process

The assembly sequence of type-2 assemblies can be modeled in a manner similar to that for type-1 assemblies except for the fact that it is possible to control the process using feedback controllers. At assembly stations where a contact is established, the absorption zone of the contact can be used to tune out some of the variation accumulated so far along a KC chain. This would amount to reducing the size of the variation ellipsoids along the directions that the contact can influence. We define the 6×1 vector describing the absorption zone of the contact feature as the assembly control input, $\tilde{U}(k)$. A zero element in this vector would indicate the inability of the contact to affect the variation along the direction represented by the element. $\tilde{U}(k)$ is a property of the assembly feature at the contact. Hence, in general, only a subset of the accumulated error may be affected by a single contact.

If we describe the amount of variation that can be absorbed out by a contact feature as a region in space, the absorption zone can be represented by a 6×1 vector. This is illustrated by the following example.

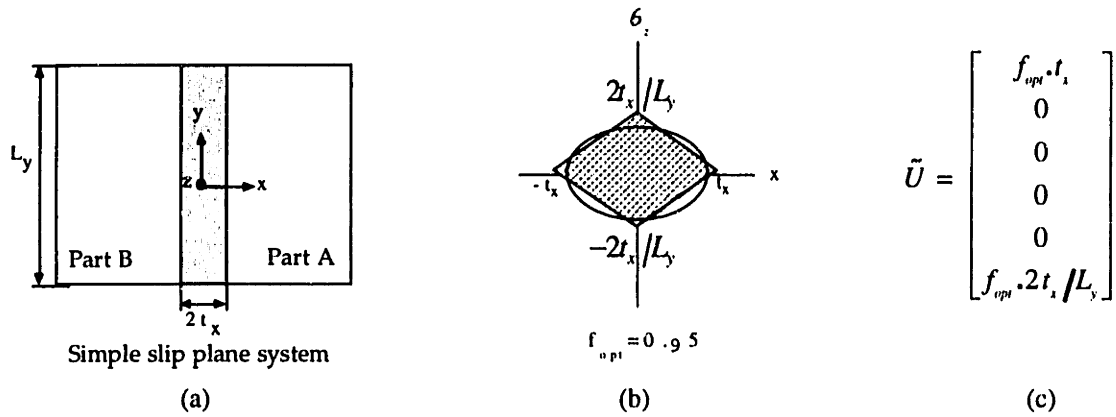

Figure 5-3: (a) A simple slip plane type contact feature (b) variation absorption zone and (c) its corresponding \tilde{U} vector

Figure 5-3 shows a simple slip plane type contact feature and its absorption zone. This feature can absorb translational errors along the x axis and rotational errors about the z axis. The absorption zone defined in the parametric space is shown in Figure 5-3(b). The analytical solution is based on the independence of the variates while the model of reality involves obvious dependencies. As shown in (Whitney, et al. 1994), the idea is to approximate the parameter space with an ellipse generated by assuming un-correlated variates. An optimization was performed to modify the parameter ranges for the ellipse to best approximate the diamond. f_{opt} is the optimization factor that results from this optimization. Details of the optimization can be found in (Whitney, et al. 1994). The 6×1 vector representing the absorption zone is shown in Figure 5-3 (c).

The state transition equation for type-2 assemblies can thus be written as:

$$\begin{aligned}
 \tilde{X}(k+1) &= A(k)\tilde{X}(k) + B(k)\tilde{U}(k) + F(k)\tilde{w}(k) \\
 \tilde{y}(k) &= C(k)\tilde{X}(k)
 \end{aligned}
 \tag{5-9}$$

The assembly operation is a two stage process: a variation accumulation stage and a variation absorption stage as shown in Figure 5-4. In assembly operations that do not close any loop during assembly (do not establish any contacts), the control term ($B(k)\tilde{U}(k)$) disappears and the

above equation reduces to the type-1 state equation described earlier. $B(k)$ transforms $\tilde{U}(k)$ (the vector describing the adjustable zone for the contact) from the coordinates of part k to the base coordinates for the KC chain. The elements of $B(k)$ are determined by the DFC.

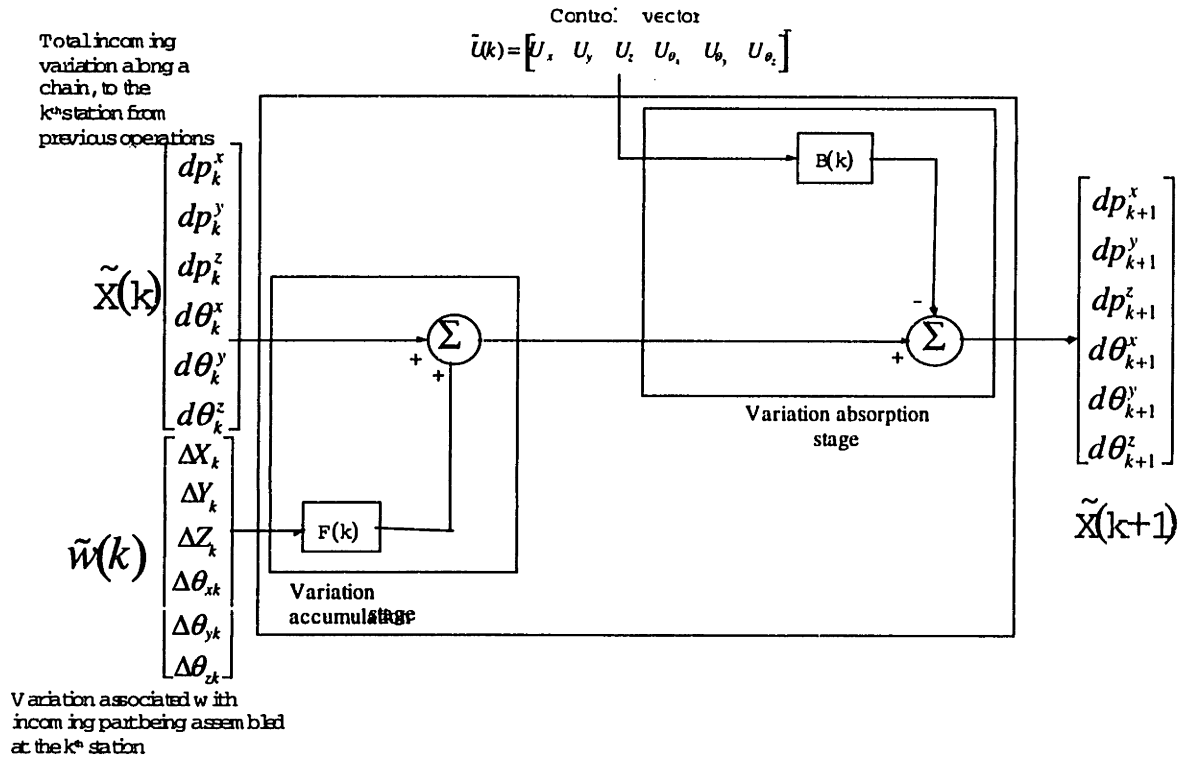

Figure 5-4: State transition model for type-2 assemblies at assembly stations where contacts are established and adjustment is possible

5.6 Summary

This chapter re-emphasized the need for differentiating between two fundamentally different types of assemblies and further developed the idea of Datum Flow Chain to design assemblies. Discrete event state space models were developed to model these two types of assemblies. It was shown that the assembly process could be represented as a linear time varying system. Variation in type-1 assemblies is determined by the variation contributed by each of its constituting parts. However, in type-2 assemblies, the assembly process can dictate the final variation distribution. In type-2 assemblies, there is freedom to select assembly features to suit assembly needs, and

feature design is an integral part of assembly design and planning. The state transition model forms a unified framework to analyze the four types of variation propagation problems.

The state space representation of a mechanical assembly process allows for applying control systems theory concepts to designing assemblies. Concepts of controllability can be explored to determine the ability of the locating scheme determined by a DFC to observe and control variation in a mechanical assembly. These concepts prove useful to answer questions about when and where to take measurements during an assembly process and if the variation in an assembly is controllable. The modeling environment allows for control theory concepts to be exploited to design optimal controllers to regulate the assembly process disturbed by variation modeled as random noise. These concepts are described in the next chapter.

“ Find the simplest possible example that will illustrate the thing you want to illustrate. With time instead of adding complexity, add insights”

- Daniel Whitney

6.

Variation Propagation and Control

6.1 Overview

This chapter presents algorithms to propagate and control variation in mechanical assemblies using the State Transition Model approach introduced in chapter 5. It exploits the modeling environment and uses concepts from control theory to model variation propagation and control during assembly. The assembly process is modeled as a multi-stage linear dynamic system. Section 6.2 describes the modeling of variation propagation in type-1 assemblies. Algorithms developed to model the propagation of variation in the presence of adjustments in type-2 assemblies are described in section 6.3. Section 6.4 describes the use of control theory principles to develop a scientific approach to designing interfaces between parts in response to manufacturing and measurement errors.

6.2 Modeling variation propagation in Type-1 assemblies

It was shown in chapter 5 that variation propagation along a tolerance chain can be expressed using a state transition equation of the form:

$$\begin{aligned}\tilde{X}(k+1) &= A(k)\tilde{X}(k) + F(k)\tilde{w}(k) \\ \tilde{y}(k) &= C(k)\tilde{X}(k)\end{aligned}\tag{6-1}$$

where the state of the system is defined by the 6×1 error vector $\tilde{X}(k)$. The index k indicates the k^{th} assembled part along the chain. The other terms in the equation are defined as follows:

$\tilde{w}(k)$: 6×1 vector describing the variation associated with the part being assembled at the k^{th} assembly station, expressed in local part coordinates

$\tilde{X}(k+1)$: 6×1 vector describing the total variation accumulated after the k^{th} assembly station, defined and measured in the base coordinate frame for the KC chain. This becomes the input to the $(k+1)^{\text{th}}$ assembly station

$\tilde{U}(k)$: 6×1 vector describing the absorption zone of the contact feature as the assembly control input,

and

$A(k)$: Identity matrix

$F(k)$: 6×6 matrix that transforms the variation associated with the incoming part at the k^{th} assembly station from part k 's coordinate frame to the base coordinate frame of the KC chain.

$B(k)$: 6×6 matrix that transforms $\tilde{U}(k)$ from the coordinates of part k to the base coordinates for the KC chain.

The assembly sequence of type-1 assemblies is modeled as a multi-stage linear dynamic system driven by a Gauss-Markov random sequence, as shown in Figure 6-1. The density function $\Pr[\tilde{X}(k)]$ describing the variation in $\tilde{X}(k)$ is therefore completely defined by giving two

deterministic sequences, the mean state vector $\bar{X}(k) = E[X(k)]$ and the state covariance matrix

$$P(k) = E\left\{\left[\tilde{X}(k) - \bar{X}(k)\right]\left[\tilde{X}(k) - \bar{X}(k)\right]^T\right\}$$

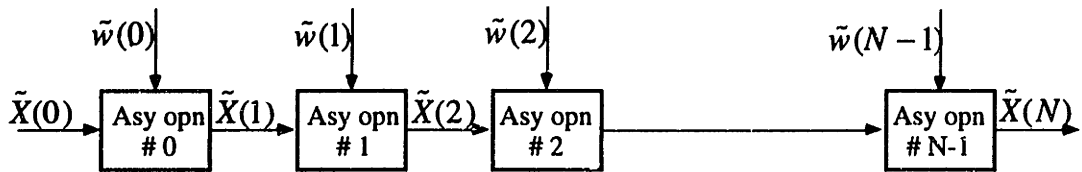

Figure 6-1: A discrete multi stage system representing a type-1 assembly process

$\tilde{w}(k)$, $k = 0, 1, 2, \dots, N$, is defined as a sequence of mutually un-correlated, zero-mean, vector valued stochastic vectors (n-vector) with the following properties:

$$\begin{aligned} E[\tilde{w}(k)] &= 0, \\ E\{\tilde{w}(k)\tilde{w}^T(l)\} &= \begin{cases} V(k), & k = l \\ 0, & k \neq l \end{cases} \\ E[\tilde{X}(0)] &= \bar{X}(0), \\ E\left\{\left[\tilde{X}(0) - \bar{X}(0)\right]\left[\tilde{X}(0) - \bar{X}(0)\right]^T\right\} &= P(0), \\ E\left\{\left[\tilde{X}(0) - \bar{X}(0)\right]\left[\tilde{w}(0) - \bar{w}(0)\right]^T\right\} &= 0. \end{aligned} \quad (6-2)$$

$\tilde{w}(k)$ is described as Gaussian discrete-time white noise process. A block diagram representation of the same is shown in Figure 6-2.

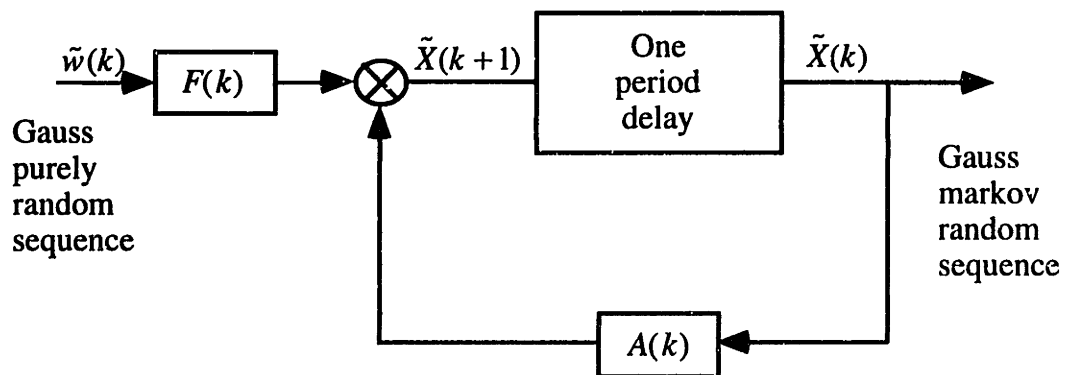

Figure 6-2: Block diagram representation of type-1 assembly operation described as a Gauss Markov sequence driven by white noise

The initial state is Gaussian with mean value $\bar{X}(0)$ and covariance $P(0)$. The relations to determine $\bar{X}(k)$ and $P(k)$ can be determined readily by taking expected value of (1) as follows (Bryson, et al. 1975):

$$\boxed{\bar{X}(k+1) = A(k)\bar{X}(k) + F(k)\bar{w}(k), \quad \bar{X}(0) \text{ given, } \bar{w}(k) = 0} \quad (6-3)$$

Subtracting (6-2) from (1) and multiplying by its transpose and then taking expected value of both sides yields:

$$\boxed{P(k+1) = A(k)P(k)A^T(k) + F(k)V(k)F^T(k), \quad P(0) \text{ and } V(k) \text{ given,}} \quad (6-4)$$

(6-3) and (6-4) are linear difference equations for the mean value vector and covariance matrix. They are not coupled and, hence the sequences $\bar{X}(k)$ and $P(k)$ may be calculated separately. They completely specify the evolution of the density function $\Pr[\tilde{X}(k)]$. Each new part added to the assembly adds more uncertainty to the system (modeled as $\tilde{w}(k)$). Pictorially, the one dimensional case can be visualized as follows in Figure 6-3:

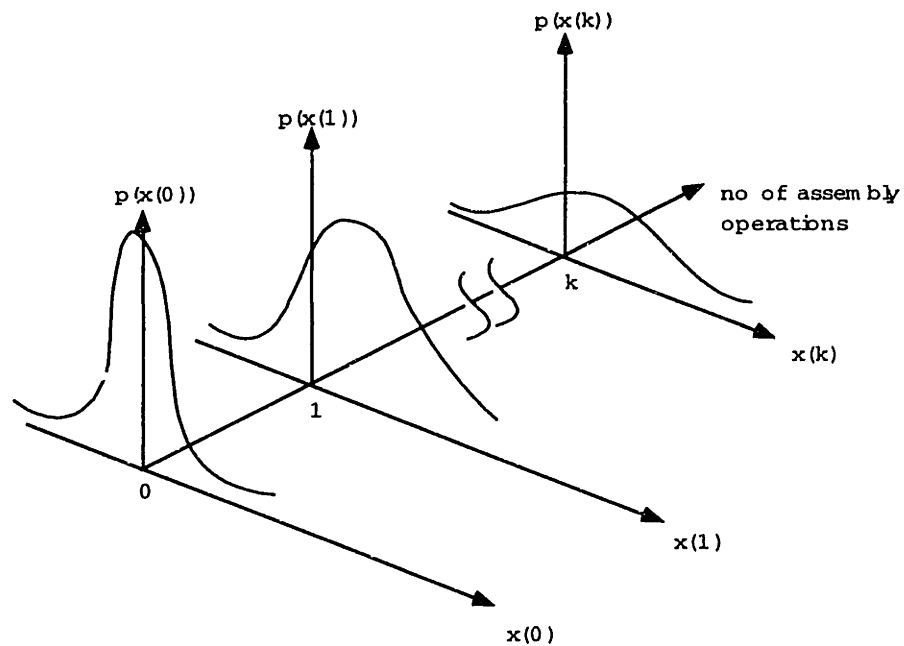

Figure 6-3: Evolution of probability density of a state variable in type-1 assemblies after k assembly operations

$P(N)$ computed at the end of N assembly operation yields the covariance matrix for a particular KC chain at the end of the assembly process. $P(N)$ is of the form $P(N) = \begin{bmatrix} V_p & 0 \\ 0 & V_\theta \end{bmatrix}$ where V_p, V_θ are 3×3 covariance matrices of the translation and rotation vector associated with the N^{th} frame. A non zero mean for $\tilde{w}(k)$ indicates that there is some mean shift in addition to statistical variation associated with part k .

6.2.1 Example study

The state transition model was applied to an example assembly from (Nevins, et al. 1989) and results were compared with the tolerance analysis algorithm developed by Whitney et al (Whitney, et al. 1994). The problem analyzed is of class 2 as described in chapter 4. The model reproduced the results obtained by Whitney et al, thus validating the application of state transition models to study propagation of variation in assemblies.

Two assembly sequences were compared for the assembly shown in Figure 6-4. The parts in question belong to a real product that could not be assembled with acceptable probability using

the most convenient assembly sequence. The assembly is illustrated on page 220 of (Nevins, et al. 1989) and a complete tolerance analysis using Gilbert's approach can be found in (Gilbert 1992).

Figure 6-4 shows the assembly under study and all the constituent parts with their tolerance assignments. The assembly sequence and controlling DFC that were analyzed for probability of assembly failure when adding impeller (part D) is shown in Figure 6-5(a) and (b) respectively. The planned sequence fixtures the assembly on the bottom of Part B. But in fact part B's bottom surface is not reliably perpendicular to the axis due to loose tolerances, so the shaft (part C) tilts and the impeller could strike it during assembly. This is a real case, and redesign to improve part tolerances was not permitted. Figure(c) shows the resulting error ellipses for position error, which is the limiting factor for this assembly operation.

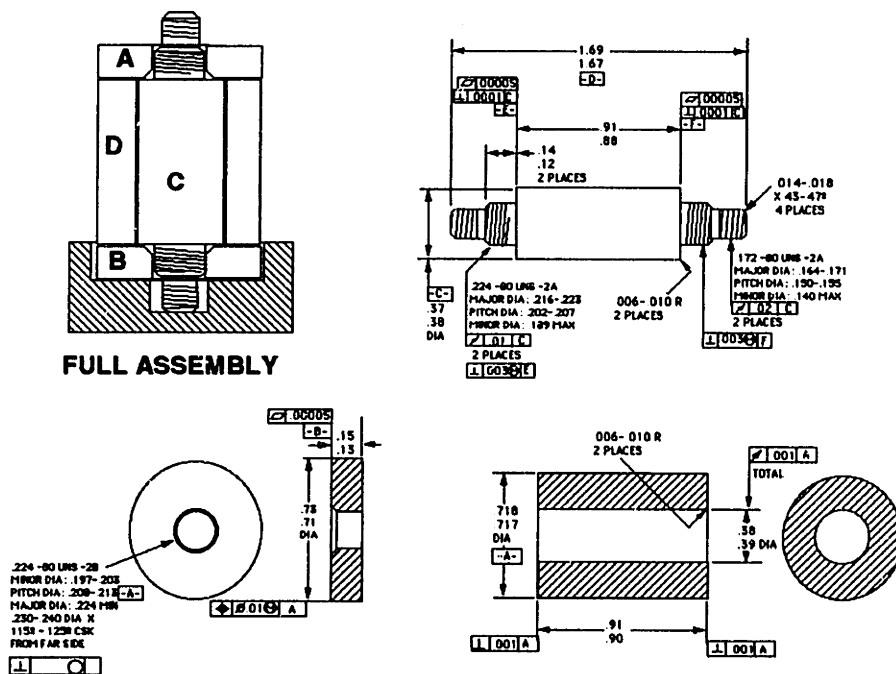

Figure 6-4: Example assembly showing individual parts and their tolerance assignments (Gilbert 1992)

An improved DFC and resulting assembly sequence are shown in Figure 6-6. This sequence transfers the B-C subassembly to a new fixture that holds the shaft by its much better tolerated end. This sequence worked because the B-C subassembly's angular error in fixture #2 is not large

enough to prevent the shaft from mating to it. The associated error ellipse for this DFC indicates success almost all the time. The sequence in Figure 6-6 was eventually used for assembly.

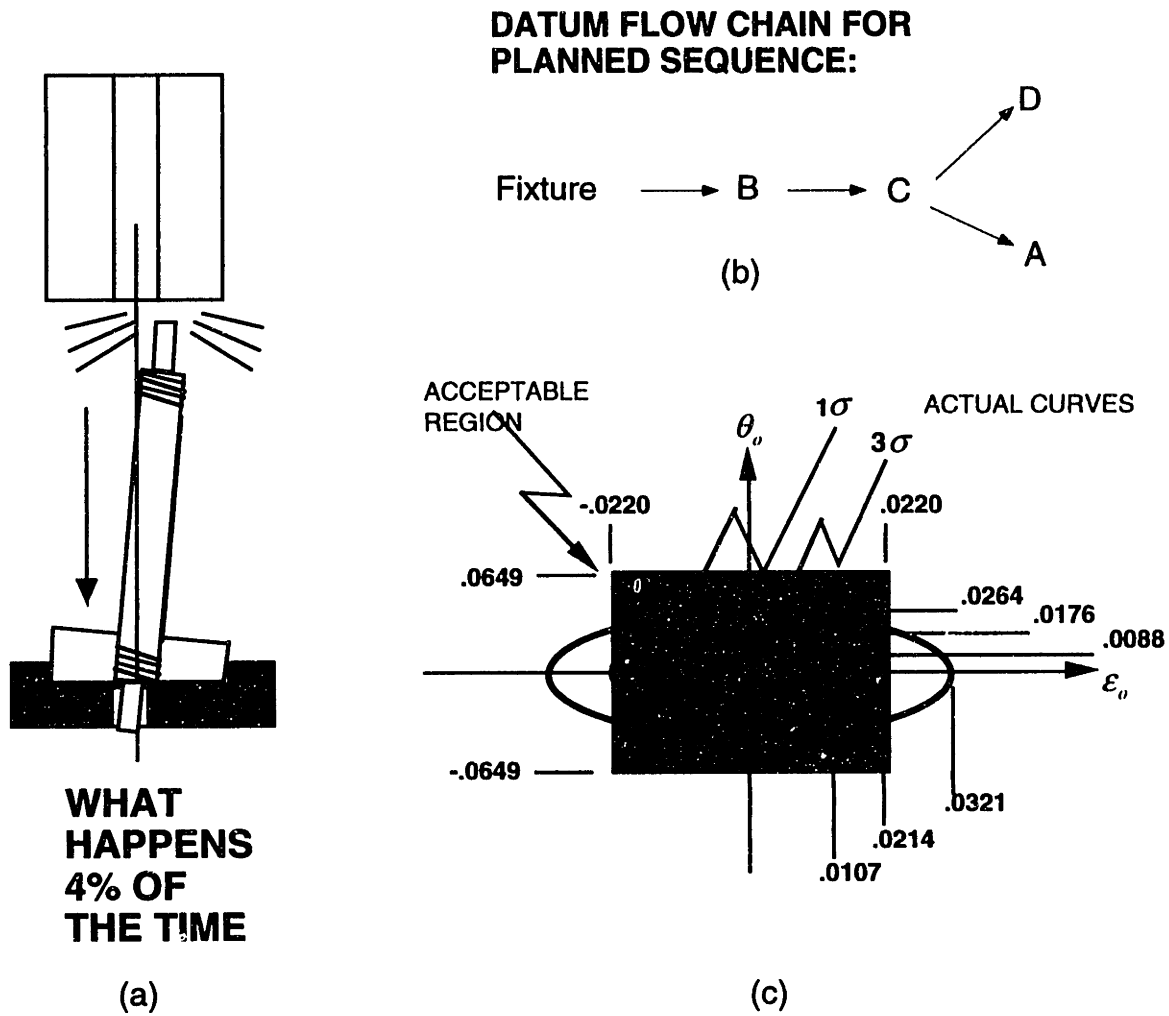

Figure 6-5: (a) planned assembly sequence (b) controlling DFC (c) Result of variation propagation analysis; assembly is predicted to fail 4% of the time

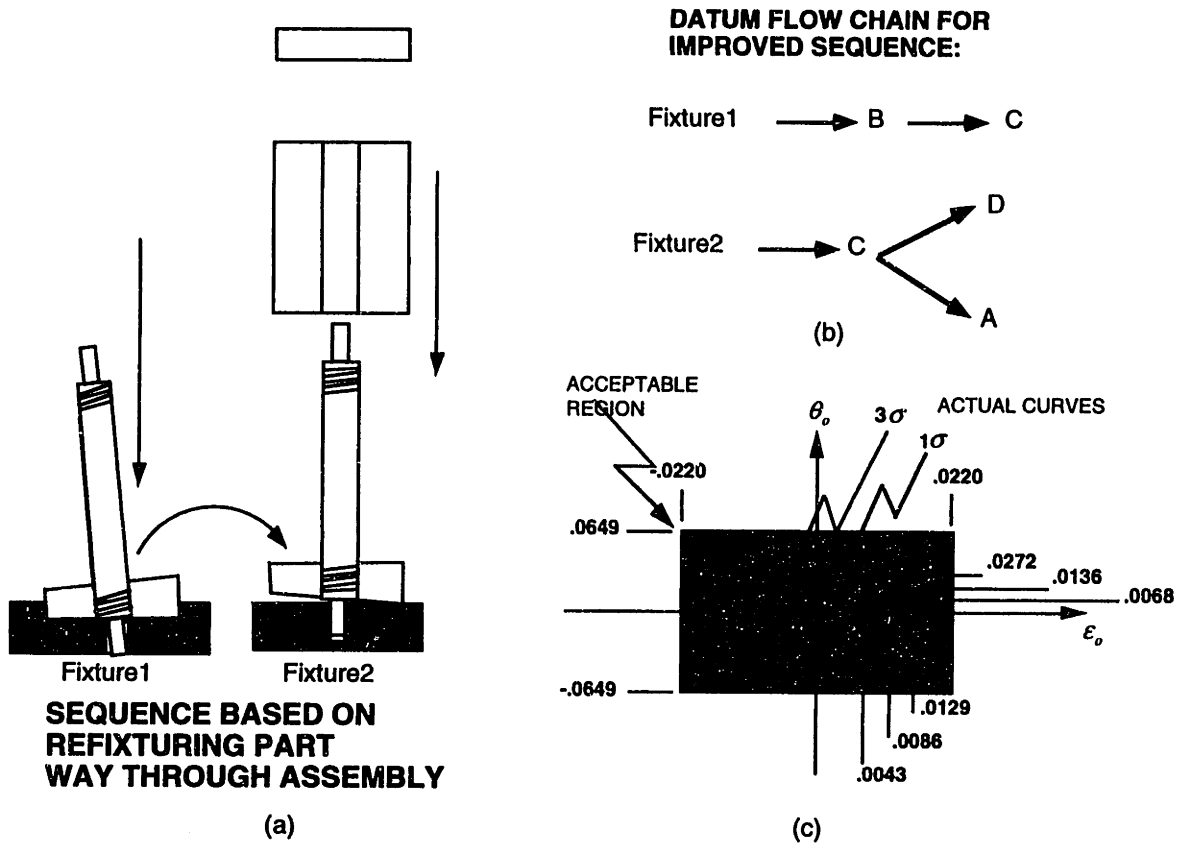

Figure 6-6: (a) Assembly sequence resulting from an improved DFC employing two fixtures (b) the improved DFC (c) assembly is predicted to fail only 0.001% of the time

6.3 Modeling variation propagation in Type-2 assemblies

The idea of using contacts as variation absorption zones to tune out some variation in the assembly process makes the type-2 assembly process an active process. We define the 6×1 vector describing the absorption zone of the contact feature as the assembly control input, $\tilde{U}(k)$ (Mantripragada, et al. 1997). A zero element in this vector would indicate the inability of the contact to affect the variation along the direction represented by the element. $\tilde{U}(k)$ is the property of the assembly feature at the contact. The following derives an error propagation algorithm incorporating in-process adjustment capability. For a given set of contact features, i.e. a given set of $\tilde{U}(k)$ vectors, this algorithm will determine the resulting variation distribution after assembly. The following variation propagation algorithm is applied every time the assembly process establishes a contact.

6.3.1 Variation propagation in the presence of adjustments

We describe the type-2 assembly process as a multistage linear discrete-time regulation problem whereby we want to keep the state of the system close to the origin, shown in Figure 6-7. It is represented using the following linear model:

$$\tilde{X}(k+1) = A(k)\tilde{X}(k) + B(k)\tilde{U}(k) + F(k)\tilde{w}(k) \quad (6-5)$$

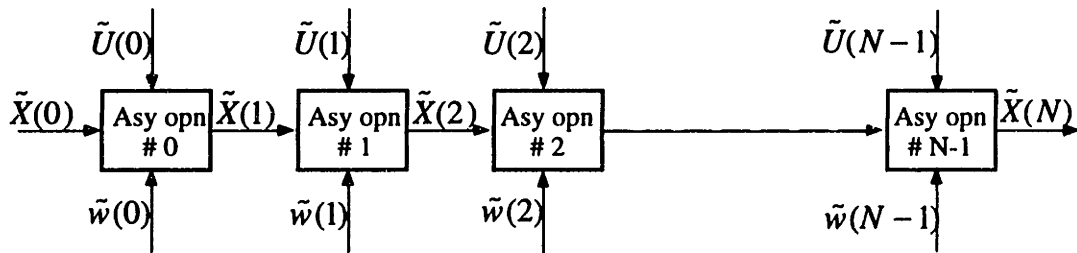

Figure 6-7: A discrete multi stage system representing a type-2 assembly process

The following derives an error propagation algorithm incorporating in-process adjustment capability. It is an extension of the work done by Soyucali and Otto (Soyucali, et al. 1997) in modeling the effect of tuning variables (that represent factory floor manufacturing adjustments) to minimize variability of product performance. Let σ_{pre} be the standard deviation of the variation associated with a variable before any tuning adjustment is made. This is the variation that we wish to adjust out. For the sake of simplicity, the following derivation is performed for one random variable only. The procedure can however be generalized to a vector of random variables (such as $\tilde{X}(k)$). U_x defines the total range of adjustment that a contact feature can accommodate along the direction of the variable (defined in the local coordinate frame of the part) and t_x defines this range transformed to the base coordinate frame for the KC. Note that, in general, not all of the accumulated error can be tuned out at any individual assembly station.

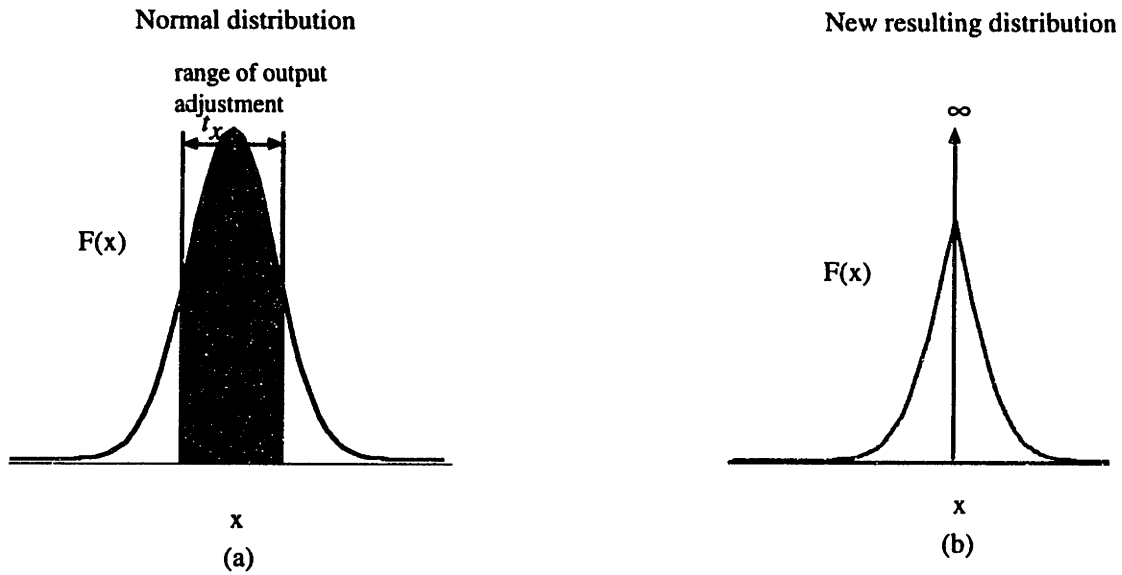

Figure 6-8: (a) Pdf before tuning. Shown shaded is the range of output that can be tuned out (b) Resulting prob. density function after tuning

The pdf for the random variable x , (assuming Gaussian) is given as:

$$pdf(x) = \frac{1}{\sqrt{2\pi}\sigma_{pre}} e^{-x^2/2\sigma_{pre}^2} \quad (6-6)$$

t_x is the range of output adjustment for this random variable x . The shaded region shown in Figure 6-8 (a) will be tuned out after the adjustment process. The new distribution of the variation after the adjustment is shown in Figure 6-8 (b), with a delta function at zero.

The new pdf is given as follows:

$$pdf(x) = \begin{cases} \frac{1}{\sqrt{2\pi}\sigma_{pre}} e^{-x^2/2\sigma_{pre}^2}, & x < 0_- \\ erf\left(\frac{t_x\sqrt{2}}{2\sigma_{pre}}\right) \delta(x), & 0_- \leq x \leq 0_+ \\ \frac{1}{\sqrt{2\pi}\sigma_{pre}} e^{-x^2/2\sigma_{pre}^2}, & x > 0_+ \end{cases}$$

(6-7)

The variance of this new distribution after adjustment is given as (Soyucali, et al. 1997)

$$\sigma_{post}^2 = \frac{1}{\sqrt{2\pi}\sigma_{pre}} \int_{-\infty}^0 x^2 e^{-\frac{(x-t_x)^2}{2\sigma_{pre}^2}} dx + \frac{1}{\sqrt{2\pi}\sigma_{pre}} \int_0^{\infty} x^2 e^{-\frac{(x+t_x)^2}{2\sigma_{pre}^2}} dx$$

$$\sigma_{post}^2 = (t_x^2 + \sigma_{pre}^2) \left(1 - \operatorname{erf} \left(\frac{t_x}{\sqrt{2}\sigma_{pre}} \right) \right) - \sqrt{\frac{2}{\pi}} \sigma_{pre} t_x e^{-\frac{t_x^2}{2\sigma_{pre}^2}}$$

(6-8)

As seen above the distribution resulting after tuning adjustments is not normal. The 3 sigma probability for this distribution is given as follows:

$$P(-3\sigma < x < 3\sigma) = 1 - \left\{ \int_{-\infty}^{-3\sigma} \frac{1}{\sqrt{2\pi}\sigma_{pre}} e^{-\frac{(x-t_x)^2}{2\sigma_{pre}^2}} dx + \int_{3\sigma}^{+\infty} \frac{1}{\sqrt{2\pi}\sigma_{pre}} e^{-\frac{(x+t_x)^2}{2\sigma_{pre}^2}} dx \right\}$$

For our variation propagation algorithm, we have assumed all the variables to be independent and normally distributed. For the sake of simplicity of formulation, we seek to approximate the distribution in (6-7) by an equivalent normal distribution. To approximate this distribution by a normal distribution, the standard deviation $\sigma_{neq.}$ of the equivalent normal distribution is chosen such that it has the same probability value for the range $-3\sigma < x < 3\sigma$ as the parent distribution. This means that the equivalent normal distribution would reject the same number of parts as the parent distribution given in Equation. (6-7). The SD for the normal distribution $\sigma_{neq.}$ for particular values of t_x is determined as follows, shown in Figure 6-9:

$$\int_{-3\sigma}^{3\sigma} \frac{1}{\sqrt{2\pi}\sigma_{neq.}} e^{-\frac{x^2}{2\sigma_{neq.}^2}} dx = P(-3\sigma < x < 3\sigma)$$

$$\int_{-3\sigma}^{3\sigma} \frac{1}{\sqrt{2\pi}\sigma_{neq.}} e^{-\frac{x^2}{2\sigma_{neq.}^2}} dx = 1 - \left\{ \int_{-\infty}^{-3\sigma} \frac{1}{\sqrt{2\pi}\sigma_{pre}} e^{-\frac{(x-t_x)^2}{2\sigma_{pre}^2}} dx + \int_{3\sigma}^{+\infty} \frac{1}{\sqrt{2\pi}\sigma_{pre}} e^{-\frac{(x+t_x)^2}{2\sigma_{pre}^2}} dx \right\}$$

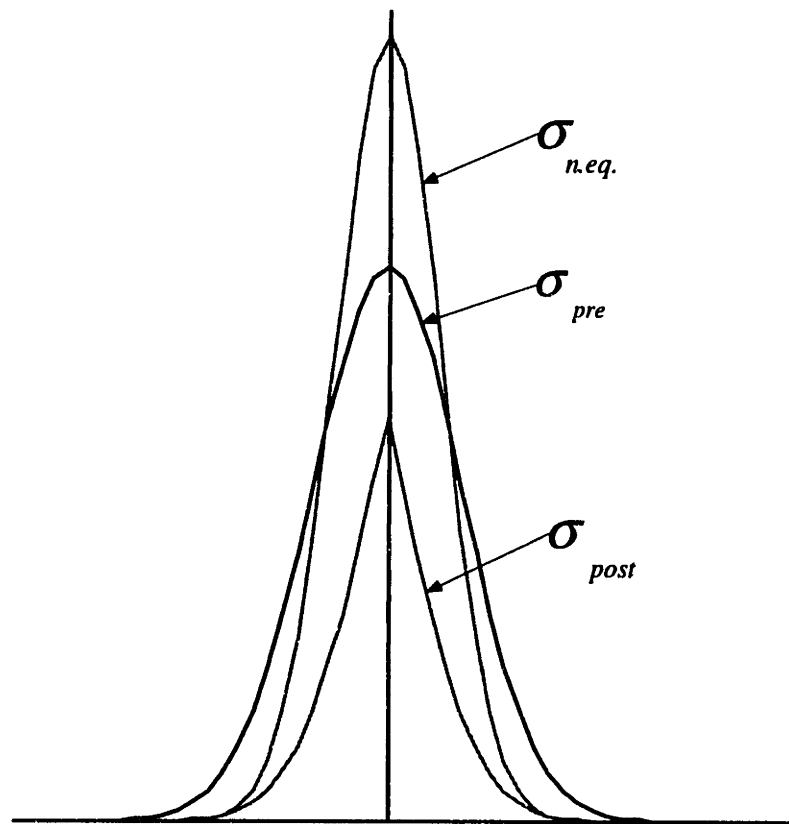

Figure 6-9: Probability Density functions for variable x before making adjustments, after making adjustments and after approximation by a equivalent normal distribution

Similarly, the distributions for the other variables constituting the state vector $\tilde{X}(k+1)$ can be computed at the end of the k^{th} assembly operation after making tuning adjustments. If the assembly operation does not involve establishment of any contacts, then the distributions remain unaltered except for the uncertainty added by the part k . Hence in assembly operations where contacts are established, the variation absorption methodology is shown in Figure 6-10. Since the error distributions are assumed to be independent normal distributions, each one can be tuned individually. The tuned distributions are then approximated by their equivalent normal distributions.

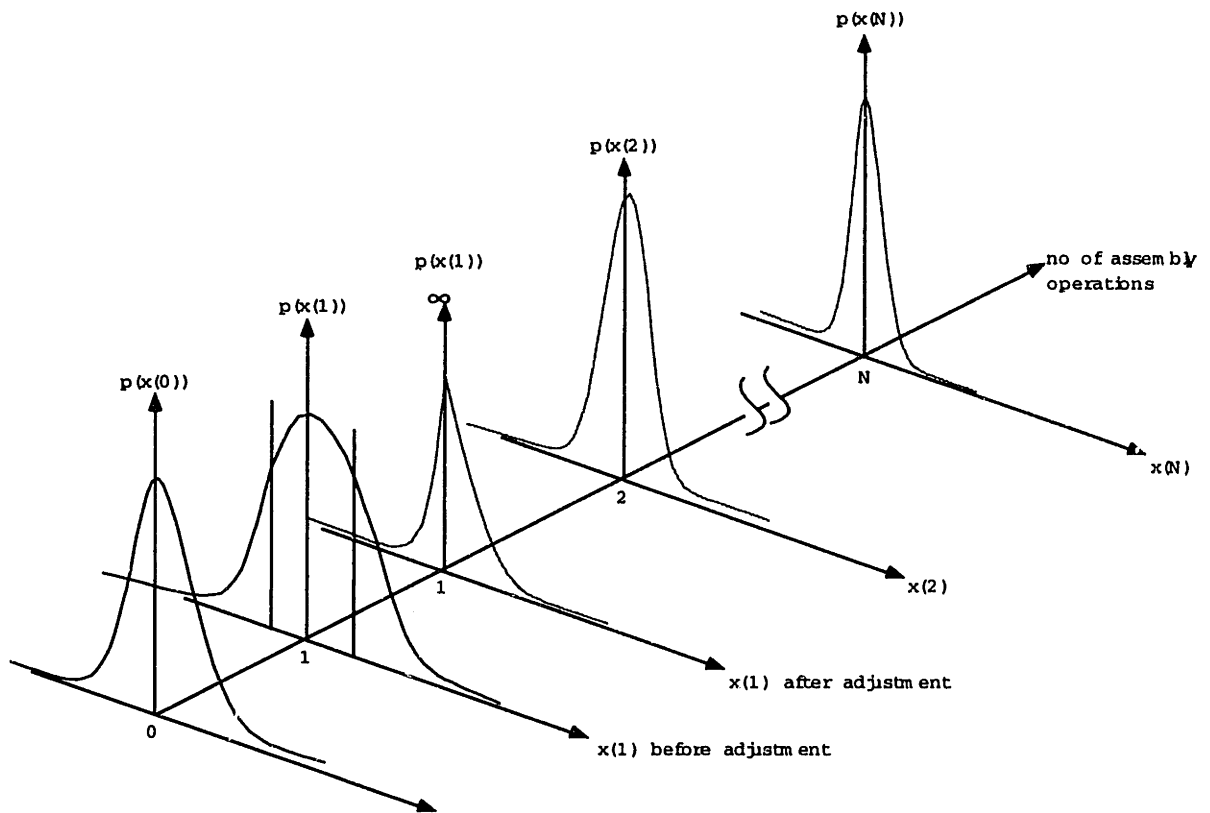

Figure 6-10: Variation absorption methodology for type-2 assemblies

6.3.2 Assembly sequence analysis

Different assembly sequences will establish the same contacts at different stages of the assembly process and hence will have different resulting variation distributions. Hence, depending upon the assembly sequence, the size and shape of these probability density distributions at the end of the assembly process will be different. Thus for type-2 assemblies, the state of the KC chains at any assembly station is a function of the path taken to arrive at that station. We call this property of type-2 assemblies *path dependency*.

The goodness of the assembly sequence in delivering a KC can be evaluated by the probability that all the resulting errors at the end of the assembly sequence are within the desired limits. If the specified tolerance limits on the six error variables are as follows:

$$\begin{bmatrix} \Delta \varepsilon_{x \max} \\ \Delta \varepsilon_{y \max} \\ \Delta \varepsilon_{z \max} \\ \Delta \varepsilon_{\theta_x \max} \\ \Delta \varepsilon_{\theta_y \max} \\ \Delta \varepsilon_{\theta_z \max} \end{bmatrix} = \text{tolerance limits on the KC, then:}$$

$$\Pr \left\{ \left(-\Delta \varepsilon_{x \max} \leq dp_n^x \leq \Delta \varepsilon_{x \max} \right) \& \dots \& \left(-\Delta \varepsilon_{\theta_z \max} \leq d\theta_n^z \leq \Delta \varepsilon_{\theta_z \max} \right) \right\} = \\ \Pr \left(-\Delta \varepsilon_{x \max} \leq dp_n^x \leq \Delta \varepsilon_{x \max} \right) \times \dots \times \Pr \left(-\Delta \varepsilon_{\theta_z \max} \leq d\theta_n^z \leq \Delta \varepsilon_{\theta_z \max} \right) \quad (6-10)$$

since all the statistical variables are assumed to be independent.

This probability value is used as a metric to evaluate between different assembly sequences.

6.3.3 Example study

Figure 6-11 shows a simple 1-D type-2 assembly consisting of three sheet metal parts A, B, and C. The mean values and SDs of the lengths of these parts are also shown in the figure. The overall length of the assembly is a KC and has a tolerance of ± 1.25 units on it. The exact amount of overlap between parts B and C (slip plane feature) is less important and is a “contact” feature for this assembly that can be used to absorb variation during assembly. The slip plane can be characterized by the vector $\tilde{U} = \Delta b$. There are two assembly operations for this assembly but only one control vector \tilde{U} , as there is only one contact feature in this assembly. Two different assembly sequences derived from two different Datum Flow Chains will be compared.

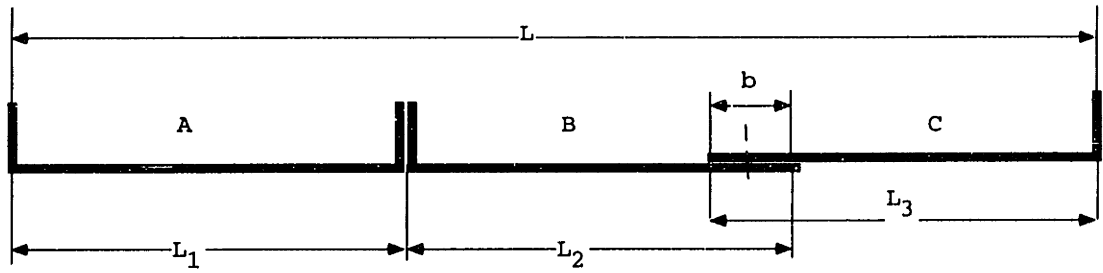

$$L = L_1 + L_2 + L_3 - b$$

L_1 : Mean = 5, SD = 0.75

L_2 : Mean = 6, SD = 0.3

L_3 : Mean = 6, SD = 0.4

b : Mean = 1, Range = 0.7

Figure 6-11: A type-2 example consisting of three sheet metal parts

Assembly sequence #1 in Figure 6-12 first assembles parts A and B. As shown in the DFC for the assembly process, part A locates B completely. The variation associated with the length of the subassembly AB (L_{AB}) is a cummulation of the individual part length variations. The next assembly operation establishes the contact BC. Part C and subassembly AB are located by the fixture F. In-process measurements are taken with respect to datums on the assembly fixture, to control the amount of overlap between parts B and C to absorb variation accumulated in operation #1 and associated with part C. The amount of variation that can be tuned out is determined by the allowable range Δb property of the slip plane feature at BC. The resulting SD associated with L is 0.564 (determined by applying Equation. (6-7) for operation #2) and the KC is delivered with a probability 0.9736.

Liaison diagram #1

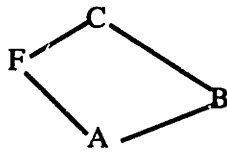

DFC #1

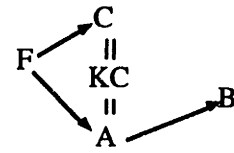

Assembly Sequence #1

Assembly Operation #1



Distribution after first assembly operation

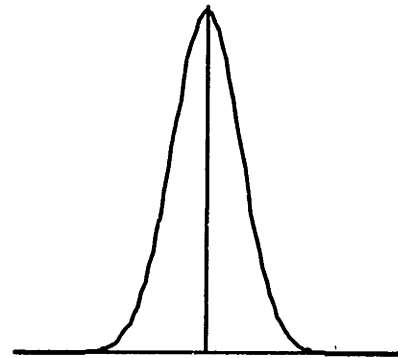

Assembly Operation #2

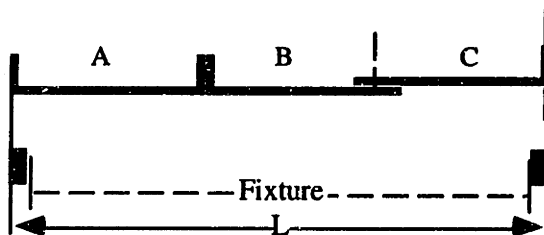

Distributions after second assembly operator

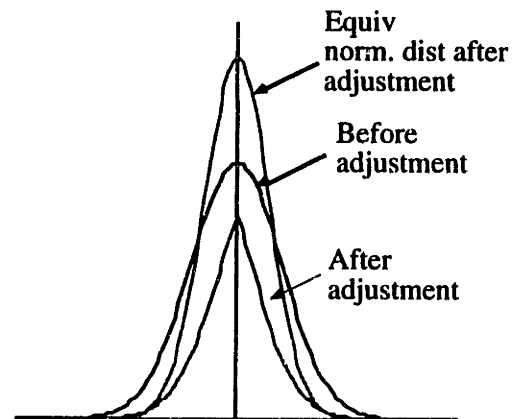
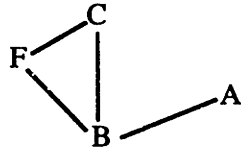
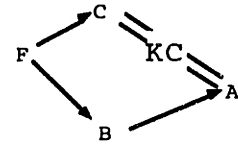

Figure 6-12: Variation propagation analysis in the presence of adjustments using state transition models: assembly sequence #1

Liaison diagram #2



DFC #2



Assembly Operation #2

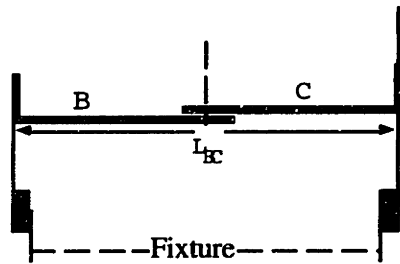

Distributions after first assembly operation

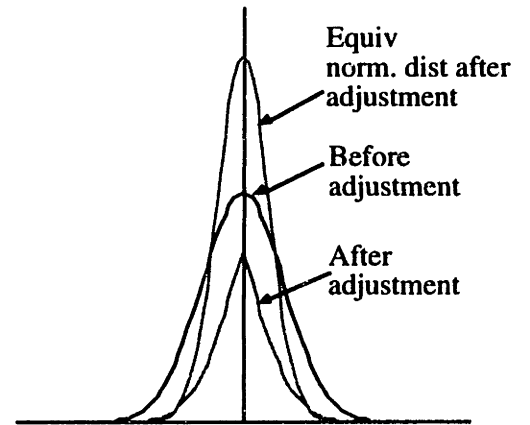

Assembly Operation #2

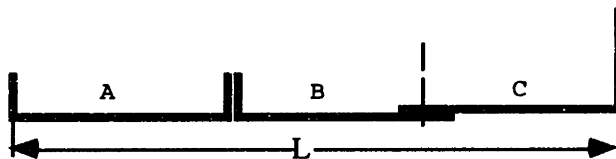

Distribution after second assembly operator

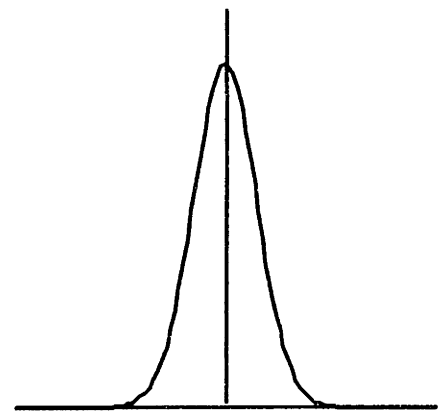

Figure 6-13: Variation propagation analysis in the presence of adjustments using state transition models: assembly sequence #2

Sequence #2 in Figure 6-13 establishes the contact BC in the first assembly operation and hence can reduce the effect of variation associated with parts B and C only. Hence the length of the subassembly BC (L_{BC}) is controlled. The assembly process, however, has no control over the variation contributed by part A. The resulting SD associated with L is 0.8183. This assembly process will deliver the KC with a probability 0.7508. Here Equation. (6-7) is applied for operation #1. Any measurements made in the second assembly operation will only confirm if the KC is within specification, but no control can be exercised if the KC is out of specification

6.4 Control of variation propagation in Type-2 assemblies

Section 6.3 described an algorithm to determine the resulting distribution of variation in an assembly process in the presence of a given set of adjustments. These adjustments were the result of a particular design consisting of a given set of contact features. Here we present a technique to intelligently design these contact features to provide the necessary freedom to make the appropriate adjustments during assembly. Assembly adjustment values $\tilde{U}(k)$ can be determined in response to the noise variations $\tilde{w}(k)$ introduced by the manufacturing processes used to fabricate individual parts.

Modeling variation in assemblies using state transition models enables us to exploit the analogy between designing contact features for type-2 assemblies and optimal controllers for linear systems. Before designing a controller, it is necessary to determine if the system is controllable. Controllability defined with respect to mechanical assemblies will be described in section 6.4.1. The design of these optimal controllers usually involves minimizing a certain performance measure. The design of a suitable performance measure is itself a complex design activity and can be different under different design and operating environments. We propose a general performance measure in section 6.4.2 that captures the essential design criteria. In section 6.4.3, we describe the procedure to design assembly features to control the propagation of variation in type-2 assemblies.

6.4.1 Output Controllability

Controllability (Bryson, et al. 1975) is a property of control systems that guarantees the existence of controls that can drive the state of the system to a desired value. In practical design of control

systems, we usually wish to control the output rather than the state of the system. In the case of mechanical assemblies, output controllability guarantees the existence of mating features (controls) that will provide adjustments capable of delivering the KCs. Hence, it is necessary to determine if the system is output controllable before designing the optimal controller for the system.

Equation (6-11) is used to model error propagation and control in type-2 assemblies:

$$\begin{aligned}\tilde{X}(k+1) &= A(k)\tilde{X}(k) + B(k)\tilde{U}(k) + F(k)\tilde{w}(k) \\ \tilde{y}(k) &= C(k)\tilde{X}(k)\end{aligned}\tag{ 6-11}$$

Linear control assumes unbounded control in all directions and hence the elements of control vector can take any magnitude. Once the optimal controller is designed, the control vector needs to be translated into a mating feature combination. Controllability as defined in control theory does not guarantee the existence of physical assembly features that can implement the controller. The mapping from mating feature to $\tilde{U}(k)$ is one-to-one (as shown in (Mantripragada, et al. 1997)) but the mapping from $\tilde{U}(k)$ to mating feature is a one-to-many and hence there are infinite solutions possible. On the other hand, in some cases there might not be any physical feature set that can achieve the desired $\tilde{U}(k)$. We define “realizability” as the property of a control vector if a feature set exists for given $\tilde{U}(k)$ vector.

To ensure realizability, we define $\tilde{U}(k)$ as:

$$\tilde{U}(k) = T(k)\tilde{u}(k)\tag{ 6-12}$$

where

$\tilde{u}(k)$: 6×1 unbounded control vector used in the control law

$T(k)$: 6×6 matrix defining and constraining the contributing elements of $\tilde{u}(k)$

The elements of matrix $T(k)$ are chosen to force the \tilde{U} vector to take a particular realizable form. Typically the elements of the T matrix would be 1s and 0s indicating which local directions are adjustable. Different feature types and orientations provide different adjustment options. The elements of $T(k)$ reflect one choice of feature for each k and must be chosen by the designer. Automatic determination of $T(k)$ is the subject of future research.

After designing the structure of $T(k)$, before designing a controller, it is essential to determine if the system is controllable. This in terms of mechanical assembly process would translate to determining if the complete set of chosen contact features can influence all the state variables of interest as determined by the KCs.

Then a necessary condition for the mechanical assembly system to be completely output controllable is:

$$\text{rank} \begin{bmatrix} C_0 B_0 T_0 & | & C_1 B_1 T_1 & | & \dots & | & C_N B_N T_N \end{bmatrix} = r \quad (6-13)$$

where r is the dimension of the \tilde{y} vector as defined in (6-11).

6.4.2 Performance Measure

The assembly process is modeled as a discrete time linear dynamic system. The problem is a combination of

Terminal control problem: To minimize the deviation of the final state of a system from its desired value. We want the error associated with final assembly dimension to be as close to zero as possible. A suitable performance measure chosen is of the type:

$$J = [\tilde{y}(N) - \tilde{r}(N)]^T S [\tilde{y}(N) - \tilde{r}(N)]$$

where $\tilde{r}(N)$ is the desired reference value of the final state vector. Since, in our case $\tilde{r}(N) \equiv 0$, the performance measure chosen is:

$$J = \tilde{y}^T(N)S\tilde{y}(N)$$

S is an $n \times n$ positive semi-definite weighting matrix. By adjusting the element values of S we can weight the relative importance of the deviation of components of the final state vector from their desired values.

Minimum control effort problem: To transfer a system from an arbitrary state $X(k) = X_k$ to a specific target set with a minimum expenditure of control effort. In our system, control effort indicates the amount of in-process adjustment made during the assembly process. Since that involves measurement and actuation or design and maintenance of a fixture, we would like to minimize the amount of adjustment needed throughout the assembly process. The general form of a suitable performance measure is as follows:

$$J = \sum_{k=0}^{N-1} \tilde{u}^T(k)R(k)\tilde{u}(k)$$

where $R(k)$ is a time varying real symmetric positive definite weighting matrix. Linear control assumes that all the elements of the control vector are unbounded and hence $\tilde{u}(k)$ is used in the optimization function instead of $\tilde{U}(k)$. The elements of R are chosen to vary the weighting on control-effort expenditure during the assembly process. A very high value of $R_{i,i}(k)$ is chosen at assembly stations where tuning is undesirable or not possible (absence of a contact) and a low value of $R_{j,j}(l)$ is chosen where it is desirable to perform control action.

Tracking problem: To maintain the system state $\tilde{X}_i(N)$ as close as possible to the desired state $\tilde{r}(k)$ ($\tilde{r}(k) = 0$ in our model) throughout the assembly process. The performance measure chosen is:

$$J = \sum_{k=0}^{N-1} \tilde{X}^T(k)Q(k)\tilde{X}(k)$$

where Q is an $n \times n$ real symmetric matrix that is positive semi-definite. The elements of Q are selected to weight the relative importance of the different components of the state vector and to normalize the numerical values of the deviations. In addition elements of $Q(k)$ are also used to weight the relative importance of different states in the assembly process.

By combining the three measures, the performance measure to control the assembly process takes the following quadratic form:

$$J = \tilde{X}^T(N)S\tilde{X}(N) + \sum_{k=0}^{N-1} [\tilde{X}^T(k)Q(k)\tilde{X}(k) + \tilde{u}^T(k)R(k)\tilde{u}(k)]$$

A more appropriate measure would be to weight the output as follows:

$$J = \tilde{y}^T(N)S\tilde{y}(N) + \sum_{k=0}^{N-1} [\tilde{y}^T(k)Q(k)\tilde{y}(k) + \tilde{u}^T(k)R(k)\tilde{u}(k)] \quad (6-14)$$

6.4.3 Optimal Controller Design

The problem of designing contact features is that of designing features that are optimal in an average sense in response to process capabilities of the individual part & subassembly fabrication processes. This translates to designing $\tilde{U}(k)$ s that are optimal in the average sense, in the presence of random disturbances and uncertainty in measurements and initial conditions. As a start, we describe the problem as a *discrete linear system with white noise disturbance and perfect knowledge of the state* control problem. The model can easily be extended to include measurement errors and uncertainty.

We describe the type-2 assembly process as a multistage linear discrete-time regulation problem, shown in Figure 6-7, whereby we want to keep the state of the system close to the origin. As described in (Mantripragada, et al. 1997), the assembly process is modeled as a two stage process: a variation accumulation stage and a variation absorption stage.

It is represented by the following linear model:

$$\tilde{X}(k+1) = A(k)\tilde{X}(k) + B(k)T(k)\tilde{u}(k) + F(k)\tilde{w}(k) \quad (6-15)$$

which can be re-written as:

$$\begin{aligned}\tilde{X}_i(k) &= A(k)\tilde{X}(k) + F(k)\tilde{w}(k) \\ \tilde{X}(k+1) &= \tilde{X}_i(k) + B(k)T(k)\tilde{u}(k)\end{aligned}\quad (6-16)$$

where $\tilde{X}_i(k)$ is the intermediate state of the system after the variation accumulation stage of the assembly process and before the adjustment stage. The system is described as a linear system disturbed by Gaussian un-correlated white noise, where the performance index is quadratic, initial conditions are random, but perfect knowledge about the state is available. In addition we have

$$\begin{aligned}E[\tilde{w}(k)] &= 0 \\ E[\tilde{w}(k)\tilde{w}^T(l)] &= \begin{cases} V(k), & k=l \\ 0, & k \neq l \end{cases} \\ E[\tilde{X}(0)] &= \bar{X}(0), \\ E\left\{[\tilde{X}(0) - \bar{X}(0)][\tilde{X}(0) - \bar{X}(0)]^T\right\} &= P(0), \\ E\left\{[\tilde{X}(0) - \bar{X}(0)][\tilde{w}(0) - \bar{w}(0)]^T\right\} &= 0, \\ J &= \tilde{y}^T(N)S\tilde{y}(N) + \sum_{k=0}^{N-1} [\tilde{y}^T(k)Q(k)\tilde{y}(k) + \tilde{u}^T(k)R(k)\tilde{u}(k)]\end{aligned}\quad (6-17)$$

The problem is now to find $\tilde{u}(k)$ that will minimize J . This problem of determining the inputs $\tilde{u}(k)$ for $k = 0, 1, 2, \dots, N-1$, is called the stochastic discrete-time linear optimal regulator problem. Now $\tilde{w}(k)$ represent random disturbances with zero mean and short correlation times compared to the characteristic times for the system. Thus it is impossible to predict $\tilde{w}(l)$, for $l > k$, even with perfect knowledge of the state for $l < k$. Hence the optimal controller is identical to a deterministic controller.

The optimal values of $\tilde{u}(k)$ are given by the control law (Kwakernaak, et al. 1972):

$$\bar{u}(k) = -K(k)\tilde{X}_i(k), \quad k = 0, 1, \dots, N-1$$

where

$$K(k) = \left\{ R(k) + T^T(k)B^T(k)[R_1(k+1) + S(k+1)]B(k)T(k) \right\}^{-1} \\ \cdot T^T(k)B^T(k)[R_1(k+1) + S(k+1)]$$

$$\text{where } R_1(k) = C^T(k)Q(k)C(k)$$

(6-18)

The sequence of matrices $S(k)$, $k = 0, 1, \dots, N-1$, is the solution of the matrix difference equation also called the discrete time Ricatti equation

$$S(k) = [R_1(k+1) + S(k+1)][I - B(k)K(k)], \quad k = 0, 1, \dots, N-1$$

$S(N)$ given

(6-19)

$\tilde{U}(k)$ is then determined using Equation. (6-12). I is a 6×6 Identity matrix. A block diagram representation of the system is shown in Figure 6-14.

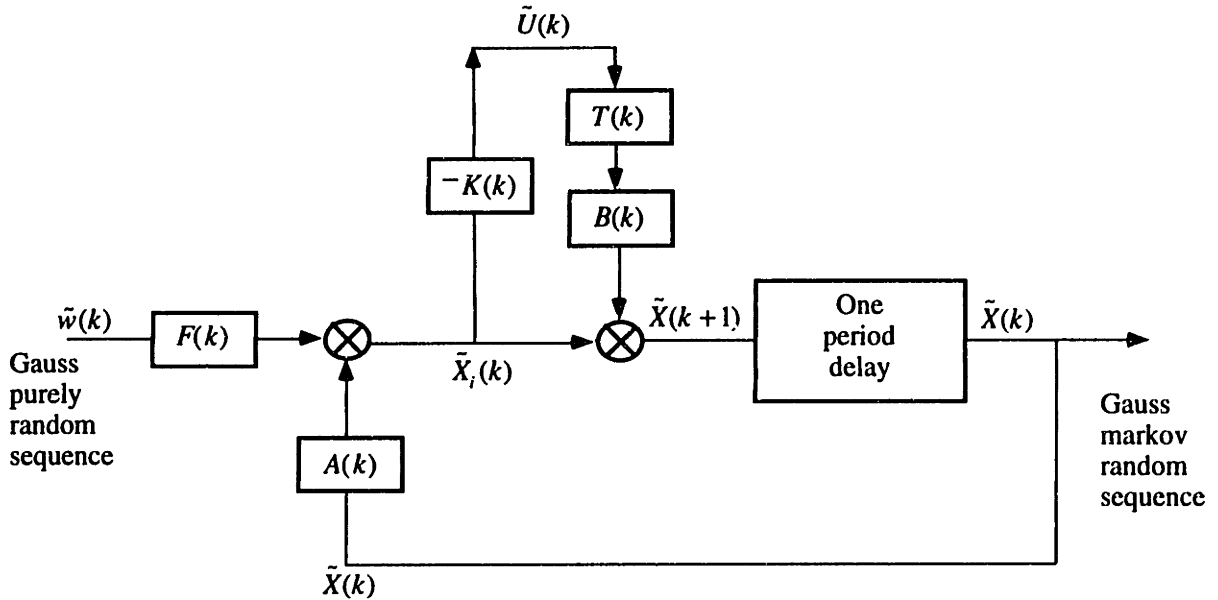

Figure 6-14: Block diagram representation of a type-2 assembly process controlled by stochastic optimal controller

Average behavior of the optimally controlled system

Substituting (6-18) in (6-15), we can rewrite the state equations as:

$$\tilde{X}(k+1) = [I - B(k)T(k)K(k)]\tilde{X}_i(k) \quad (6-20)$$

This is in the form of a Gauss-Markov random process as described in section 6.2. We are interested in the covariance matrix $P(N)$ for the state vector at the end of the assembly process. For unbounded control adjustments, this is given as:

$$\begin{aligned} P_i(k) &= A(k)P(k)A^T(k) + F(k)V(k)F^T(k) \\ P(k+1) &= [I - B(k)T(k)K(k)]P_i(k)[I - B(k)T(k)K(k)]^T, \\ &P(0) \text{ and } V(k) \text{ given,} \end{aligned} \quad (6-21)$$

$P_i(k)$ is the covariance matrix of the intermediate state vector $\tilde{X}_i(k)$. So if $\tilde{u}(k)$ is unbounded and the penalty on making in-process adjustments is low, then complete absorption of the error is possible as indicated by Equation. (6-21). This happens when $B(k)T(k)K(k)$ closely follows I .

This is achieved by assigning high values to \mathbf{S} and $\mathbf{Q}(k)$ matrix elements relative to $\mathbf{R}(k)$ elements. The mating features are designed by computing the mean square histories of the control variables as follows:

$$E[\tilde{\mathbf{U}}(k)\tilde{\mathbf{U}}^T(k)] = \mathbf{T}(k)\mathbf{K}(k)\mathbf{P}_i(k)\mathbf{K}^T(k)\mathbf{T}^T(k) \quad (6-22)$$

In the case the adjustment process has finite limits, an approximate pdf $P(k+1)$ is determined using (6-23), where $\sigma_{n.eq_j}$, $j = [x, y, \dots, \theta_z]$ are given by (6-9). σ_{pre_j} are determined from $P(k)$ and t_j are the bounded limits on the control inputs along the six directions.

$$P(k+1) = \begin{bmatrix} \sigma_{n.eq_x}^2 & 0 & \cdot & \cdot & \cdot & 0 \\ 0 & \sigma_{n.eq_y}^2 & \cdot & \cdot & \cdot & \cdot \\ \cdot & \cdot & \sigma_{n.eq_z}^2 & \cdot & \cdot & \cdot \\ \cdot & \cdot & \cdot & \sigma_{n.eq\theta_x}^2 & \cdot & \cdot \\ \cdot & \cdot & \cdot & \cdot & \sigma_{n.eq\theta_y}^2 & 0 \\ 0 & \cdot & \cdot & \cdot & 0 & \sigma_{n.eq\theta_z}^2 \end{bmatrix} \quad (6-23)$$

The linear unbounded solution given by (6-21) is used until one or more of the elements of $\tilde{\mathbf{u}}(k)$ reaches the bounds on the control elements. Once the bounds are reached the solution is approximated using equation (6-23). This is a conservative estimate of the optimal solution using a simple heuristic. A detailed proof to validate the optimality of this solution is beyond the scope of this paper.

The linear matrix equation (6-21) and approximations made using (6-23), with initial conditions (6-17) allows us to predict the mean-square histories of the state variables representing a type-2 assembly process with the possibility of adjustments. This is the same as being able to determine if the KCs can be achieved. This model can be easily extended to include output control and uncertainty in measurements. The derivation for such a case is not included in this manuscript due to space limitations.

6.4.4 Example analysis

This example will illustrate the application of control theory models to the following:

Design of an optimal set of contact features to enable selective absorption of variation during assembly. The controller defines the dofs that these features should have and the ranges of adjustment they need to permit. The controller allocates the total adjustment over a set of features in the assembly depending on the choice of the cost matrices **S**, **Q**, and **R** in response to the part size and location errors. This problem is called the adjustment space allocation problem. It is analogous to the classical problem of tolerance allocation⁵ in type-1 assemblies. Explore the effects of different ways of defining KCs that may appear equivalent but are not. The resulting set of contact features designed by the controller is very sensitive to the definition of the KCs. The controller will attempt to control variation propagation along directions critical to KC delivery and permit variation to accumulate along directions that are not of interest.

Incorporate assembly process constraints into contact feature design. For example, these can be: adjustments not being permitted at a certain assembly station, type of adjustments being limited to rectilinear motions ability to independently control adjustments along different directions at an assembly station, etc. The contact features are optimal for a particular choice of assembly sequence. The resulting set of features and **J** score can be used to compare different assembly sequences.

The use of control theory models presented above to design robust mating features between parts is illustrated using an automobile front-end assembly shown in Figure 6-15. The assembly consists of four major subassemblies: the radiator support, two inner fenders (left and right) and the main body frame. For the sake of simplicity, the assembly is modeled using two-dimensional frames.

⁵ This analogy was suggested to us by Dr. Alain Massabo, VP and Scientific Director of Matra Datavision.

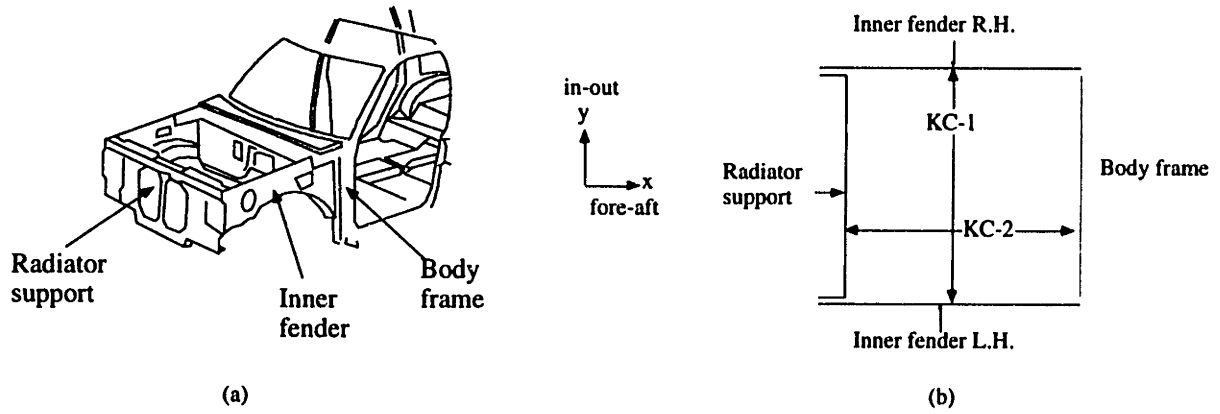

Figure 6-15: (a) Automobile front-end assembly (b) Simplified representation of the assembly in (a) (Chang 1996)

There are two KCs of interest for this assembly. The in-out location of the fenders (KC-1) measured relative to each other and the fore-aft location of the radiator support (KC-2) measured relative to the body frame. The acceptable tolerance on these KCs is ± 1.5 units. Variation associated with the build up of these subassemblies is often large enough to throw these KCs out of specification. The variation (SD) associated with the size, in-out, and fore-aft location of these sub-assemblies is given in Table 6-1(actual values altered for confidentiality purposes). When no in-process adjustments are permitted, the two KCs have an SD = 1.031 which means that these KCs are delivered only 85.44% of the time.

	length	fore-aft variation (Sigma)		in-out variation (Sigma)	
		x direction		y direction	
		value (units)	type	value (units)	type
Inner fender L.H	11	0.5	length	0.5	location
Radiator support	12	0.75	location	0.75	length
Inner fender R.H	13	0.5	length	0.5	location

Table 6-1: Uncertainties associated with the Automobile front end subassemblies

The controlling state equations are as follows:

$$\begin{aligned}
\tilde{X}_i(k) &= A(k)\tilde{X}(k) + F(k)\tilde{w}(k) \\
\tilde{X}(k+1) &= \tilde{X}_i(k) + B(k)T(k)\tilde{u}(k)
\end{aligned}
\tag{6-24}$$

$$\tilde{y}(k) = C\tilde{X}(k), \quad C = \begin{bmatrix} 1 & 0 & 0 & 0 & 0 & 0 \\ 0 & 1 & 0 & 0 & 0 & 0 \end{bmatrix}$$

$$\text{Minimize } J = \tilde{y}^T(N)S\tilde{y}(N) + \sum_{k=0}^{N-1} [\tilde{y}^T(k)Q(k)\tilde{y}(k) + \tilde{u}^T(k)R(k)\tilde{u}(k)]$$

The assembly sequence being analyzed: **LHIF to Fixture, RS to LHIF, RHIF to RS** as shown in Figure 6-16.

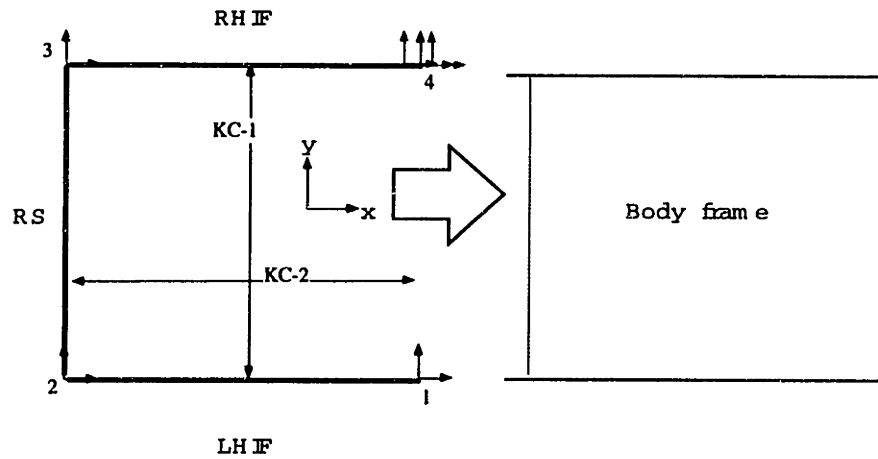

Assembly of the (LHF,RS,RHF) Subassy to the body frame

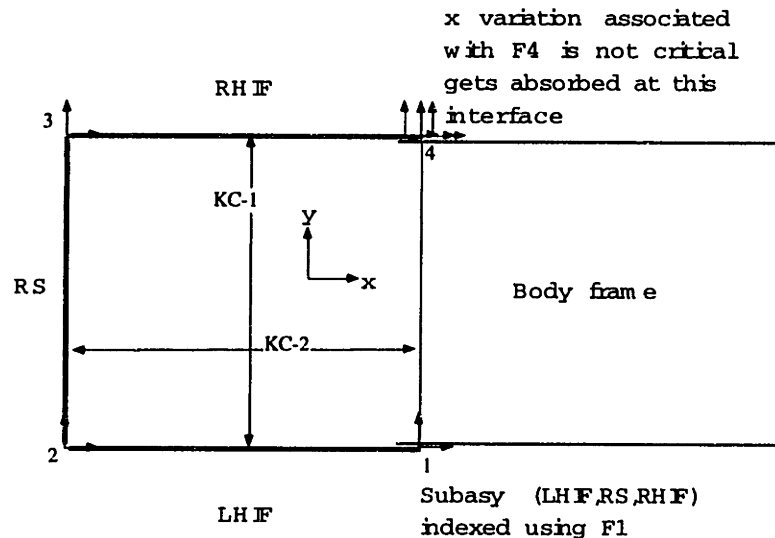

Figure 6-16: (a) Assembly of the fender-radiator subassembly to the main body frame (b) figure showing that resulting x variation associated with frame 4 is of no concern

To represent KCs in this formulation, the dimensions of interest are represented as relationships between coordinate frames placed on mating features of parts. The optimization procedure is sensitive to the how the KCs are formulated. Three formulations for this problem are presented and are discussed in detail.

6.4.4.1 Problem formulation #1

In formulation #1, the KCs of interest are monitored as follows:

KC-1 $\tilde{y}(k).[1]$ ($k=1,2,3,4$): y direction error associated with frames k measured with respect to their nominal positions. Hence variation associated with this KC is defined by $\tilde{X}(k)[1]$ and is given by $P(k)[1,1]$. (index [0] refers to x , [1] to y , ..., [5] to θ_z).

KC-2 $\tilde{y}(k).[0]$ ($k=1,2,3$): x direction error associated with frames k measured with respect to their nominal positions. We are not interested in the x variation associated with frame 4 because when this subassembly is assembled to the body frame its x location is indexed using frame 1. Hence variation associated with this KC is defined by $\tilde{X}(k)[0]$ and is given by $P(k)[0,0]$.

Based on this formulation, we assign values to $Q(k)$ and S matrices to assign importance to intermediate states of interest and drive the control action.

$$S = \begin{bmatrix} 1 & 0 \\ 0 & 10 \end{bmatrix}, Q(k) = \begin{bmatrix} 10 & 0 \\ 0 & 10 \end{bmatrix}, R(k) = \begin{bmatrix} 1 & . & . & . & . & . \\ . & 1 & . & . & . & . \\ . & . & 1 & . & . & . \\ . & . & . & 1 & . & . \\ . & . & . & . & 1 & . \\ . & . & . & . & . & 1 \end{bmatrix}$$

The S matrix is weighted to control y variation more strictly than x variation at the final assembly operation as it is directly involved with the variation associated with KC-1. Similarly, the Q matrices are chosen to control both x and y variation at intermediate assembly operations to control the KCs. In addition, $T(k)$ matrices are chosen as follows:

$$T(k) = \begin{bmatrix} 0 & . & . & . & . & 0 \\ . & 0 & . & . & . & . \\ . & . & 0 & . & . & . \\ . & . & . & 0 & . & . \\ . & . & . & . & 0 & . \\ 0 & . & . & . & . & 0 \end{bmatrix}, k = 0,1 \quad T(k) = \begin{bmatrix} 1 & 0 & . & . & . & 0 \\ 0 & 1 & . & . & . & . \\ . & . & 0 & . & . & . \\ . & . & . & 0 & . & . \\ . & . & . & . & 0 & . \\ 0 & . & . & . & . & 0 \end{bmatrix}, k = 2,3$$

Adjustments are not permitted in assembly operations 1 and 2 and hence $T(k)$ is designed to be a zero matrix for $k=0,1$.

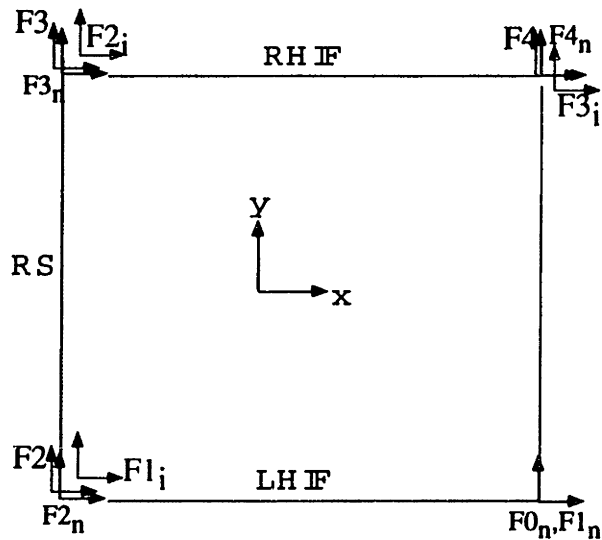

Figure 6-17: A schematic showing the coordinate frame locations on the different parts of the assembly

The location of the parts in the assembly is described by the position and orientation of coordinate frames placed on mating features on these parts (shown in Figure 6-17) and are defined as follows:

- F_k :** The true position of the coordinate frame on the mating feature on part k that mates with the locating feature on part $k-1$. $\tilde{X}(k)$ accounts for location errors associated with RHIF.
- F_{k_i} :** The true position of the coordinate frame on the mating feature on part k that mates with part $k+1$ before making any adjustments. The ideal location of this frame would have been $F(k+1)_n$. $\tilde{X}_i(k)$ describes the deviation of F_{k_i} with respect to $F(k+1)_n$. It is a result of cummulation of size errors associated with part k to $\tilde{X}(k)$.
- $F(k+1)$:** Position of the coordinate frame F_{k_i} after making the control adjustments. The control action tries to match F_{k_i} to $F(k+1)_n$ and in the event that all the error $\tilde{X}_i(k)$ is not absorbed, results in the position $F(k+1)$.

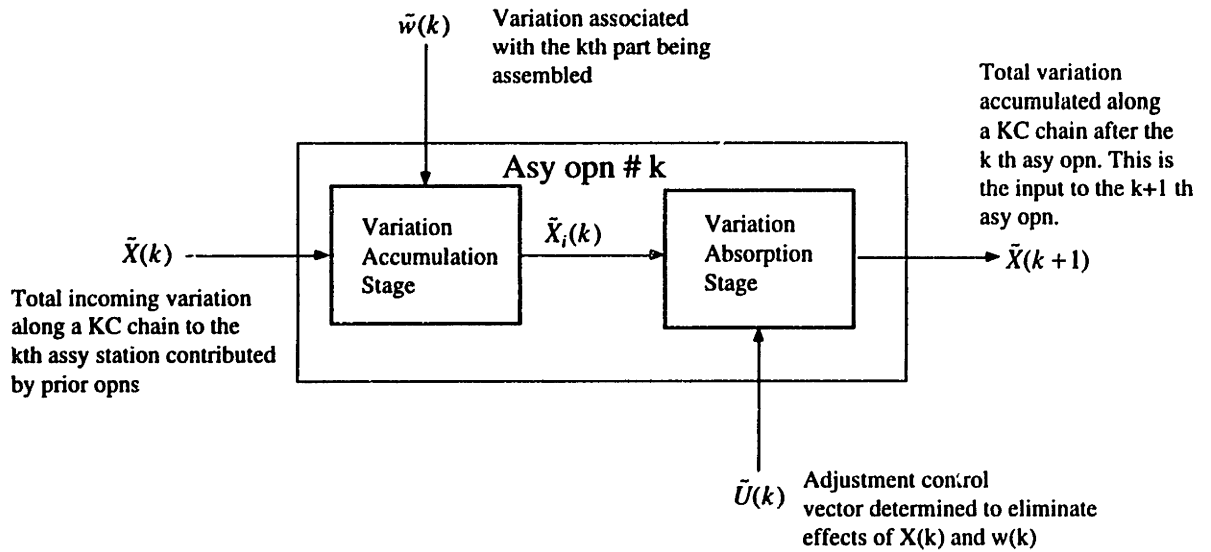

Figure 6-18: Description of control activity at the kth assembly operation

The state vectors associated with each assembly operation are shown in Figure 6-18 and defined as follows:

$\tilde{X}_i(k)$: Variation associated with the location of frame Fk_i . This is a cummulation of the location error contributed by prior assembly operations ($\tilde{X}(k)$) and size error contributed by the part k being assembled ($\tilde{w}(k)$).

$\tilde{U}(k)$: The control vector determined to eliminate $\tilde{X}_i(k)$. This means adjusting the position of the part k relative to part $k-1$ to reduce the variation. After making the adjustments, the frames on k and $k-1$ will no longer be coincident. The contact feature at this interface is designed using the elements of $\tilde{U}(k)$ and must be able to permit this adjustment.

$\tilde{X}(k+1)$: Resulting variation associated with the location of the mating feature on part k that interfaces with the mating feature on part $k+1$. The frame $F(k+1)_n$ represents the nominal location. If the control action $\tilde{U}(k)$ completely eliminates the error in this assembly operation, $\tilde{X}(k+1)$ would be zero. If not, then it becomes input to the next assembly operation.

Based on these definitions, assuming the fixture is perfect, $\tilde{X}(0)$ is a zero vector. The remaining are computed as follows:

k=0, Assembly Operation #0

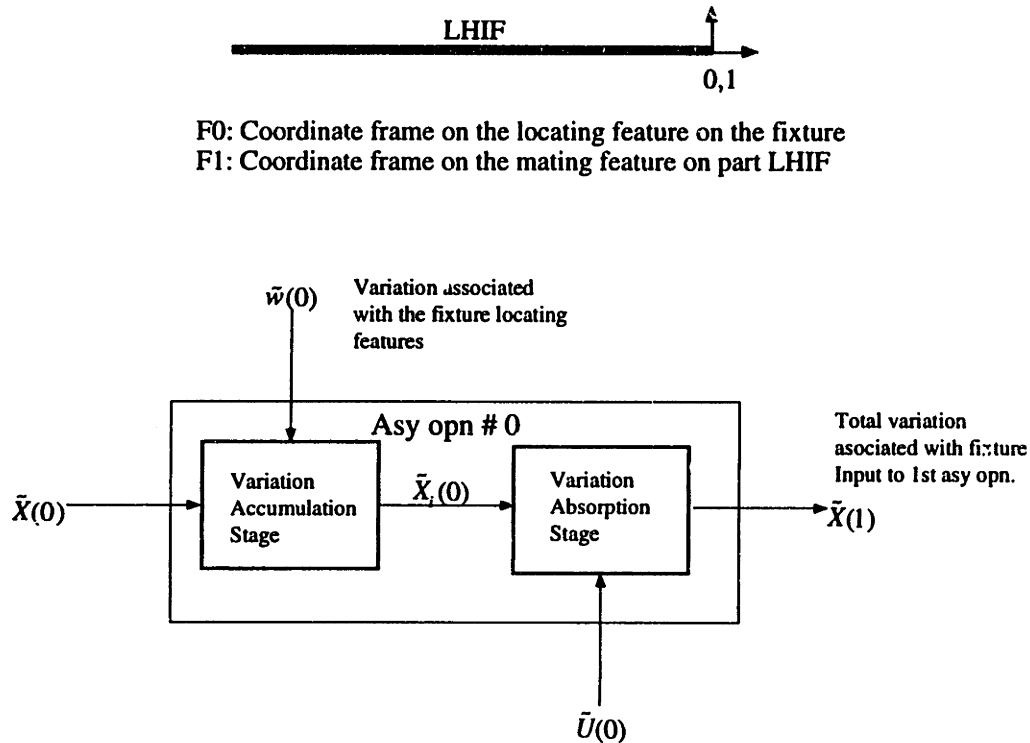

Figure 6-19: Modeling the activities at the 0th assembly operation

$$\tilde{X}(0) = 0$$

$\tilde{X}_i(0)$: Variation associated with frame 0

$\tilde{X}(1)$: Variation associated with the frame 1 on part LHIF. This is contributed by the fixture

$$\tilde{U}(0) \equiv 0$$

$$\tilde{X}_i(0) = A(0)\tilde{X}(0) + F(0)\tilde{w}(0)$$

$$\tilde{X}(1) = \tilde{X}_i(0) + B(0)T(0)\tilde{u}(0)$$

The fixture is assumed to be perfect, hence $\tilde{w}(0) \equiv 0$, thus $\tilde{X}(1) \equiv 0$ according to (1). This means that when LHIF is assembled in Assembly opn#1, the frame F1 will be in the right location, i.e. there is no location error associated with F1.

k=1, Assembly Operation #1



Figure 6-20: A schematic showing the coordinate frame locations on LHIF after 1st assembly operation

- F1:** The true position of the coordinate frame on the mating feature on LHIF that mates with the locating feature on the fixture. Since it is assumed that the fixture is perfect, 1 and 1_n are identical. Hence there are no location errors associated with LHIF.
- F1_i:** The true position of the coordinate frame on the mating feature on LHIF that mates with RS before making any adjustments. The ideal location of this frame would have been $F2_n$. $\tilde{X}_i(1)$ describes the deviation of $F1_i$ with respect to $F2_n$. It is a result of cummulation of size errors associated with LHIF to $\tilde{X}(1)$.
- F2:** Position of the coordinate frame $F1_i$ after making the control adjustments. The control action tries to match $F1_i$ to $F2_n$ and in the event that all the error $\tilde{X}_i(1)$ is not absorbed, results in the position $F2$.

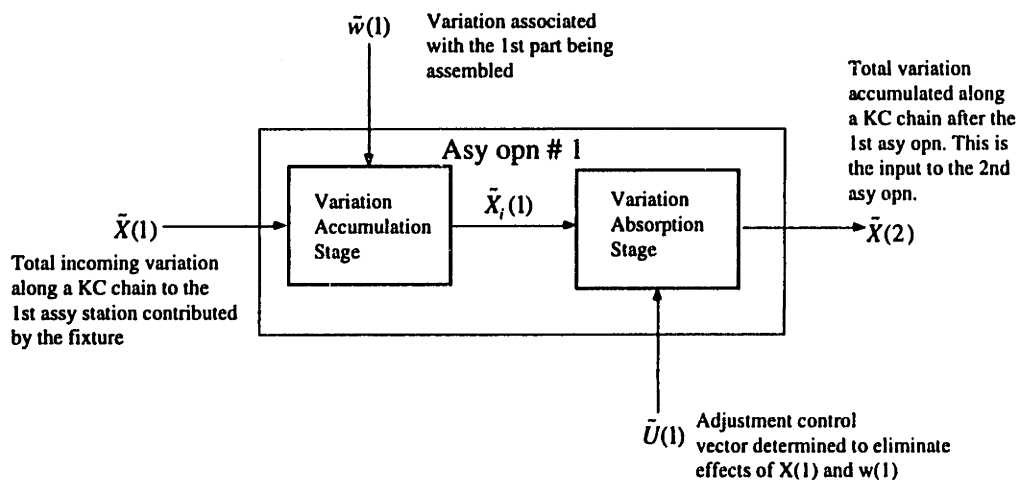

Figure 6-21: Modeling the activities at the 1st assembly operation

$$\begin{aligned}\tilde{X}_i(1) &= A(1)\tilde{X}(1) + F(1)\tilde{w}(1) \\ \tilde{X}(2) &= \tilde{X}_i(1) + B(1)\Gamma(1)\tilde{u}(1) \\ \tilde{u}(1) &= -K(1)\tilde{X}_i(1)\end{aligned}$$

$\tilde{X}_i(1)$: Variation associated with the location of frame F1_i. This is a cummulation of the location error contributed by the fixture ($\tilde{X}(1)$) and size error contributed by the part LHIF being assembled ($\tilde{w}(1)$).

$\tilde{U}(1)$: The control vector determined to eliminate $\tilde{X}_i(1)$. This means adjusting the position of the part LHIF relative to the fixture to reduce the variation. For this example, it is assumed that position of LHIF cannot be adjusted relative to the fixture and so $\tilde{U}(1)$ is designed to be a zero vector by forcing elements of $\tau(1)$ to be zero.

$\tilde{X}(2)$: Resulting variation associated with the location of the mating feature on LHIF that interfaces with the mating feature on the radiator support. The frame F2_n represents the nominal location. If the control action $\tilde{U}(1)$ completely eliminates the error in this assembly operation, $\tilde{X}(2)$ would be zero. If not, then it becomes an input to the next assembly operation.

$$V(1) = E[\tilde{w}(1)\tilde{w}^T(1)], \quad V(1) = \begin{bmatrix} 0.25 & 0 & . & . & . & 0 \\ 0 & 0.25 & . & . & . & . \\ . & . & 0 & . & . & . \\ . & . & . & 0 & . & . \\ . & . & . & . & 0 & . \\ 0 & . & . & . & . & 0 \end{bmatrix}, \quad E(\tilde{U}(1)) \equiv 0$$

$$P(2) = E[\tilde{X}(2)\tilde{X}^T(2)] \quad P(2) = \begin{bmatrix} 0.25 & 0 & . & . & . & 0 \\ 0 & 0.25 & . & . & . & . \\ . & . & . & . & . & . \\ . & . & . & . & . & . \\ . & . & . & . & . & . \\ 0 & . & . & . & . & 0 \end{bmatrix}$$

Hence variation associated with the two KCs after assembly operation#1:

KC-2 $\tilde{y}(1).[0]: \sigma_x = 0.5$

KC-1 $\tilde{y}(1).[1] : \sigma_y = 0.5$

k=2, Assembly Operation #2

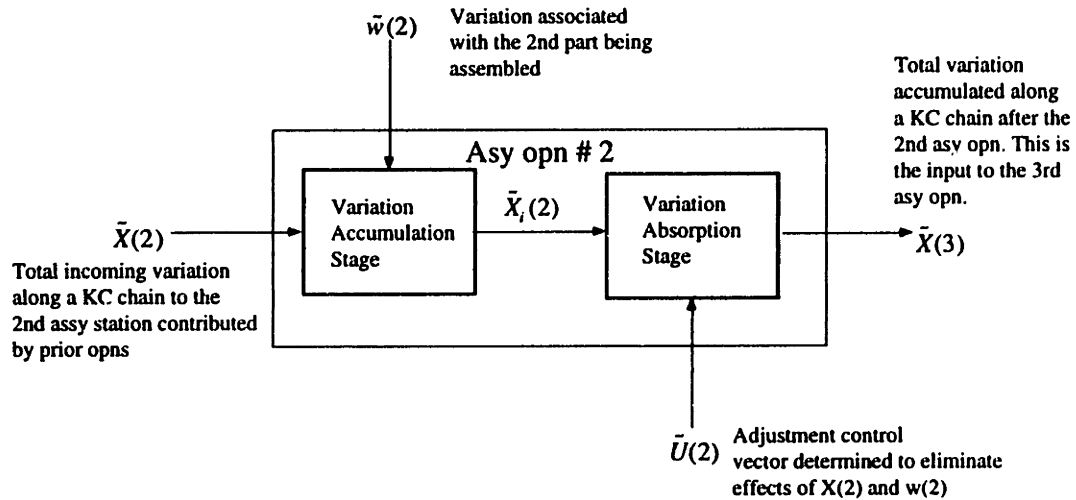

Figure 6-22: Modeling the activities at the 2nd assembly operation

$$\tilde{X}_i(2) = A(2)\tilde{X}(2) + F(2)\tilde{w}(2)$$

$$\tilde{X}(3) = \tilde{X}_i(2) + B(2)T(2)\tilde{u}(2)$$

$$\tilde{u}(2) = -K(2)\tilde{X}_i(2)$$

$\tilde{X}_i(2)$: Variation associated with the location of frame $F2_i$. This is a cummulation of the location error contributed by the LHIF ($\tilde{X}(2)$) and size error contributed by the part RS being assembled ($\tilde{w}(2)$).

$\tilde{U}(2)$: The control vector determined to eliminate $\tilde{X}_i(2)$. This means adjusting the position of the part RS relative to the LHIF to reduce the variation. After making the adjustments, the frames on RS and LHIF will no longer be coincident. The contact feature at this interface is designed using the elements of $\tilde{U}(2)$ and must be able to permit this adjustment.

$\tilde{X}(3)$: Resulting variation associated with the location of the mating feature on RS that interfaces with the mating feature on the radiator support. The frame $F3_n$ represents the

nominal location. If the control action $\tilde{U}(2)$ completely eliminates the error in this assembly operation, $\tilde{X}(3)$ would be zero. If not, then it becomes input to the next assembly operation.

$$V(2) = E[\tilde{w}(2)\tilde{w}^T(2)]. \quad V(2) = \begin{bmatrix} 0.5625 & 0 & . & . & . & 0 \\ 0 & 0.5625 & . & . & . & . \\ . & . & 0 & . & . & . \\ . & . & . & 0 & . & . \\ . & . & . & . & 0 & . \\ 0 & . & . & . & . & 0 \end{bmatrix},$$

$$E(\tilde{U}(2)) = [0.6853 \quad 0.6887 \quad 0 \quad 0 \quad 0 \quad 0]$$

$$P(3) = E[\tilde{X}(3)\tilde{X}^T(3)] \quad P(3) = \begin{bmatrix} 0.0043 & 0 & . & . & . & 0 \\ 0 & 0.004 & . & . & . & . \\ . & . & . & . & . & . \\ . & . & . & . & . & . \\ . & . & . & . & . & . \\ 0 & . & . & . & . & 0 \end{bmatrix}$$

Hence variation associated with the two KCs after assembly operation #2:

$$\text{KC-2 } \tilde{y}(3).[0] : \sigma_x = 0.0659$$

$$\text{KC-1 } \tilde{y}(3).[1] : \sigma_y = 0.0625$$

k=3, Assembly Operation #3

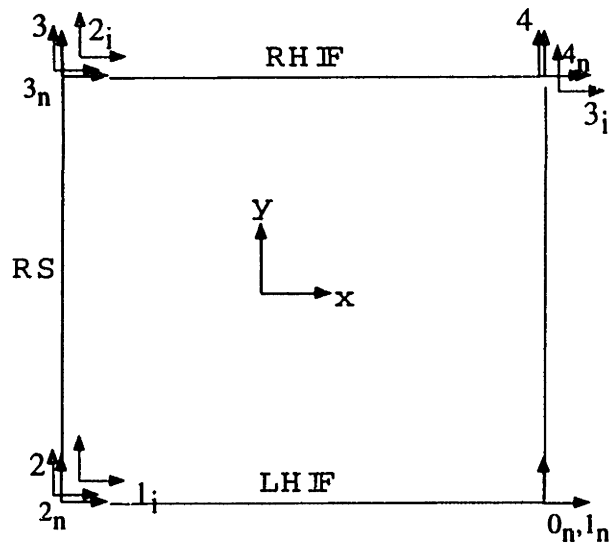

Figure 6-23: A schematic showing the coordinate frame locations on the different parts of the assembly

- F3: The true position of the coordinate frame on the mating feature on RHIF that mates with the locating feature on the RS. $\tilde{X}(3)$ accounts for location errors associated with RHIF.
- F3_i: The true position of the coordinate frame on the mating feature on RHIF that mates with body frame before making any adjustments. The ideal location of this frame would have been F4_n. $\tilde{X}_i(3)$ describes the deviation of F3_i with respect to F4_n. It is a result of cummulation of size errors associated with RHIF to $\tilde{X}(3)$.
- F4: Position of the coordinate frame F3_i after making the control adjustments. The control action tries to match F3_i to F4_n and in the event that all the error $\tilde{X}_i(3)$ is not absorbed, results in the position F4.

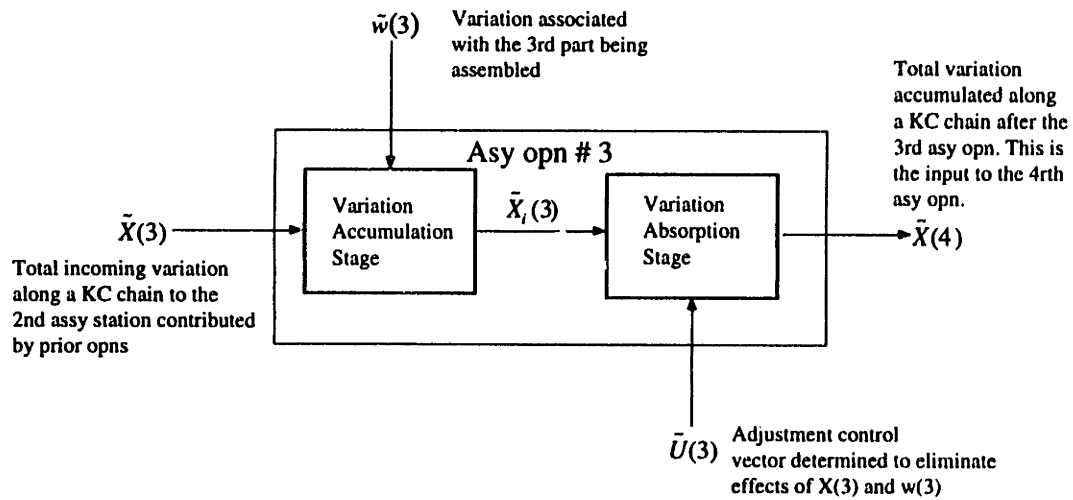

Figure 6-24: Modeling the activities at the 3rd assembly operation

$$\tilde{X}_i(3) = A(3)\tilde{X}(3) + F(3)\tilde{w}(3)$$

$$\tilde{X}(4) = \tilde{X}_i(3) + B(3)T(3)\tilde{u}(3)$$

$$\tilde{u}(3) = -K(3)\tilde{X}_i(3)$$

$\tilde{X}_i(3)$: Variation associated with the location of frame $F3_i$. This is a cummulation of the location error contributed by the RS ($\tilde{X}(3)$) and size error contributed by the part RS being assembled ($\tilde{w}(3)$).

$\tilde{U}(3)$: The control vector determined to eliminate $\tilde{X}_i(3)$. This means adjusting the position of the part RHIF relative to the RS to reduce the variation. After making the adjustments, the frames on RHIF and RS will no longer be coincident. The contact feature at this interface is designed using the elements of $\tilde{U}(3)$ and must be able to permit this adjustment.

$\tilde{X}(4)$: Resulting variation associated with the location of the mating feature on RHIF that interfaces with the mating feature on the body frame. The frame $F4_n$ represents the nominal location. If the control action $\tilde{U}(3)$ completely eliminates the error in this assembly operation, $\tilde{X}(4)$ would be zero. If not, then it becomes input to the next assembly operation.

$$V(3) = E[\tilde{w}(3)\tilde{w}^T(3)]. \quad V(3) = \begin{bmatrix} 0.25 & 0 & . & . & . & 0 \\ 0 & 0.25 & . & . & . & . \\ . & . & 0 & . & . & . \\ . & . & . & 0 & . & . \\ . & . & . & . & 0 & . \\ 0 & . & . & . & . & 0 \end{bmatrix},$$

$$E(\tilde{U}(3)) = [0.2191 \quad 0.5271 \quad 0 \quad 0 \quad 0 \quad 0]$$

$$P(4) = E[\tilde{X}(4)\tilde{X}^T(4)] P(4) = \begin{bmatrix} 0.1161 & -0.0105 & . & . & . & 0 \\ -0.0105 & 0.0021 & . & . & . & . \\ . & . & . & . & . & . \\ . & . & . & . & . & . \\ . & . & . & . & . & . \\ 0 & . & . & . & . & 0 \end{bmatrix}$$

Hence variation associated with the two KCs after assembly operation #3:

$$\text{KC-2 } \tilde{y}(4).[0] : \sigma_x = 0.3422$$

$$\text{KC-1 } \tilde{y}(4).[1] : \sigma_y = 0.0338$$

The optimal controller thus works as a regulator and depending upon the weights assigned to $Q(k)$ and S , it tries to match elements of Fk_i to Fk_n as closely as possible, by determining an optimal sequence of $\tilde{U}(k)$ vectors. For the KCs defined for the assembly, we were not interested in the x deviation associated with frame 4 and y deviation associated with frame 3. We were only interested in y deviation of frame-4 and x deviation of frame-3. The S , Q , and R matrices were designed to reflect this interest.

Interpretation of the U vector

The \tilde{U} vectors have been determined in the ensemble average sense to reduce the effects of the variation introduced by individual parts in the assembly. Part variations have been assumed to be distributed normally and are described by mean and SD. We now interpret the \tilde{U} vectors determined from optimal control algorithm. As mentioned earlier, \tilde{U} vectors were forced to be zero vectors for $k=0, 1$ as adjustment was not permitted at those assembly operations. At other assembly operations, the features should permit two independent rectilinear motion along the x

and y directions. A possible feature set using slip planes is shown in Figure 6-25. The ranges of motion that these slip planes should permit are given by the elements of the \tilde{U} vectors.

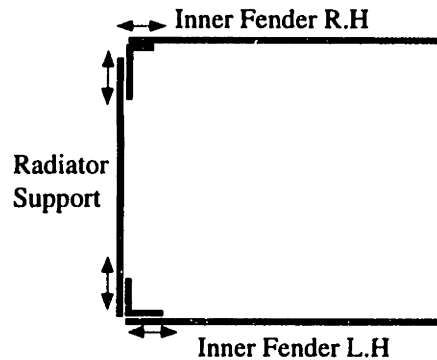

Figure 6-25: A possible contact feature design resulting from optimal control

Since these interfaces are not external surfaces visible to the customer, it is possible to implement these designs and absorb out all variation during assembly. These designs are more robust to the variations in the contributing subassemblies and deliver the KCs almost 100% of the time.

6.4.4.2 Problem formulation #2

If we define the KCs as follows instead, then the problem becomes a strictly terminal control problem:

KC-1 $\tilde{y}(4).[1]$: y direction error associated with frames 4 measured with respect to its nominal position. Hence variation associated with this KC is defined by $\tilde{X}(4).[1]$ and is given by $P(4).[1].[1]$. (index 0 refers to x , 1 to y , ..., 5 to θ_z .)

KC-2 $\tilde{y}(4).[0]$: x direction error associated with frames 4 measured with respect to its nominal position. Hence variation associated with this KC is defined by $\tilde{X}(4).[0]$ and is given by $P(4).[0].[0]$.

In this formulation, elements of only $\tilde{y}(4)$ have to be monitored to study KC delivery. In the previous formulation, the elements of $\tilde{y}(k)$, $k=1..4$ were used to define the two KCs.

Based on the KC definitions the gain matrices are defined as follows:

$$S = \begin{bmatrix} 10 & 0 \\ 0 & 10 \end{bmatrix}, Q(k) = \begin{bmatrix} 1 & 0 \\ 0 & 1 \end{bmatrix}, R(k) = \begin{bmatrix} 1 & . & . & . & . & . \\ . & 1 & . & . & . & . \\ . & . & 1 & . & . & . \\ . & . & . & 1 & . & . \\ . & . & . & . & 1 & . \\ . & . & . & . & . & 1 \end{bmatrix}$$

The **S** matrix is weighted to control location of F4 at the final assembly operation as that is directly involved with the variation associated with KCs. With such a choice of the **S**, **Q** and **R** matrices, keeping the $T(k)$ matrices the same as before, and performing the same analysis as before we arrive at the following set of \tilde{U} matrices.

Assembly Operation#2

$$E(\tilde{U}(2)) = [0.5075 \quad 0.5075 \quad 0 \quad 0 \quad 0 \quad 0]$$

$$P(3) = E[\tilde{X}(3)\tilde{X}^T(3)] \quad P(3) = \begin{bmatrix} 0.0707 & 0 & . & . & . & 0 \\ 0 & 0.0707 & . & . & . & . \\ . & . & . & . & . & . \\ . & . & . & . & . & . \\ . & . & . & . & . & . \\ 0 & . & . & . & . & 0 \end{bmatrix}$$

hence $\sigma_x = 0.2658, \sigma_y = 0.2658$.

Assembly Operation#3

$$E(\tilde{U}(3)) = [0.5148 \quad 0.5148 \quad 0 \quad 0 \quad 0 \quad 0]$$

$$P(4) = E[\tilde{X}(4)\tilde{X}^T(4)] \quad P(4) = \begin{bmatrix} 0.0027 & 0 & . & . & . & 0 \\ 0 & 0.0027 & . & . & . & . \\ . & . & . & . & . & . \\ . & . & . & . & . & . \\ . & . & . & . & . & . \\ 0 & . & . & . & . & 0 \end{bmatrix}$$

hence $\sigma_x = 0.0515, \sigma_y = 0.0515$.

Thus as defined, the 1-sigma variation associated with the KCs is 0.0515. This is just the variation associated with the frame 4, which in reality is not a true representation of the KC dimensions of interest. Frames 2 and 3 have a considerably higher variation associated with them in both axes. The KCs are actually collectively determined by frames 2, 3, and 4. Hence this is not a good formulation.

6.4.4.3 Problem formulation #3

In the above two formulations, it was assumed that the contact features can have independent degrees of freedom along the two axes of interest. Hence it was possible to control variation absorption along the two axes independently. However, if actuation can be performed only along one axis during assembly, then the two axes become coupled. The design of contact features should reflect this situation. In such cases, for the formulation #1, the contact features can be interpreted as follows:

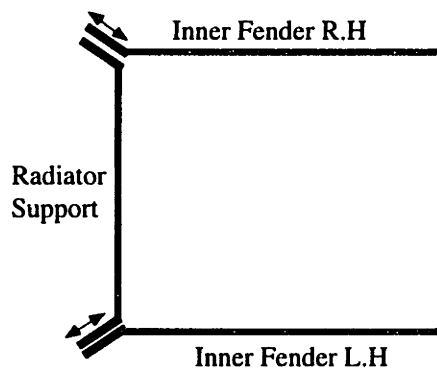

Figure 6-26: A possible contact feature design resulting from optimal control for 1 dof system

6.5 Summary

The state transition model forms a unified framework to analyze the four types of variation propagation problems. Variation propagation algorithms based on the state transition models for type-1 and type-2 assemblies were developed and presented in this chapter. These algorithms allow for variation problems of four classes described in chapter 4 to be analyzed. For type-2 assemblies, these include algorithms to determine variation propagation in presence of tuning

adjustments. These algorithms can be used to choose between different locating schemes and different assembly sequences.

The state space representation of a mechanical assembly process allows for applying control systems theory concepts to designing assemblies. Concepts of controllability were explored to determine the ability of the locating scheme determined by a DFC to control variation in a mechanical assembly. Designing a set of assembly features in type-2 assemblies is treated as designing a stochastic optimal controller to minimize variation. The resulting optimal controller is a set of assembly contact features that control the propagation of variation along certain directions to permit the assembly process to deliver all KCs in the presence of variation. Since the assembly process is modeled as a linear system with variables having Gaussian distribution, if the controls are unbounded, the optimal controller and estimation laws can be formulated separately exploiting the certainty-equivalence property of linear quadratic Gaussian controllers. Three different problem formulations were presented for the same example illustrating the flexibility of the approach in modeling different types of constraints and requirements.

Action may not always bring happiness, but there is no happiness without action

-- Benjamin Disraeli

7.

Implementation

7.1 Overview

Chapter 3 presented the assembly oriented design environment that we have defined for top down design of assemblies. This chapter describes the software implementation of the approach and outlines the various modules that have been developed to implement the techniques presented in previous chapters.

7.2 AOD Approach

In chapter 3, we presented a flow chart that gave a high level view of the AOD approach. It gave an overview of the general approach of a design environment that we have created to design assemblies. With the discussion of the several techniques developed in chapters 4, 5, and 6, we are now in a position to reconstruct a more detailed view of the AOD flowchart. This is presented in the figure below. This flowchart represents our current best understanding of the AOD approach. It is still at an evolving stage and as new modeling techniques are developed, pieces of this flowchart too will evolve to incorporate these techniques. Section 7.3 describes the

several modules in the flowchart and their characteristics. A typical design session envisioned in this AOD approach is presented in Section 7.4.

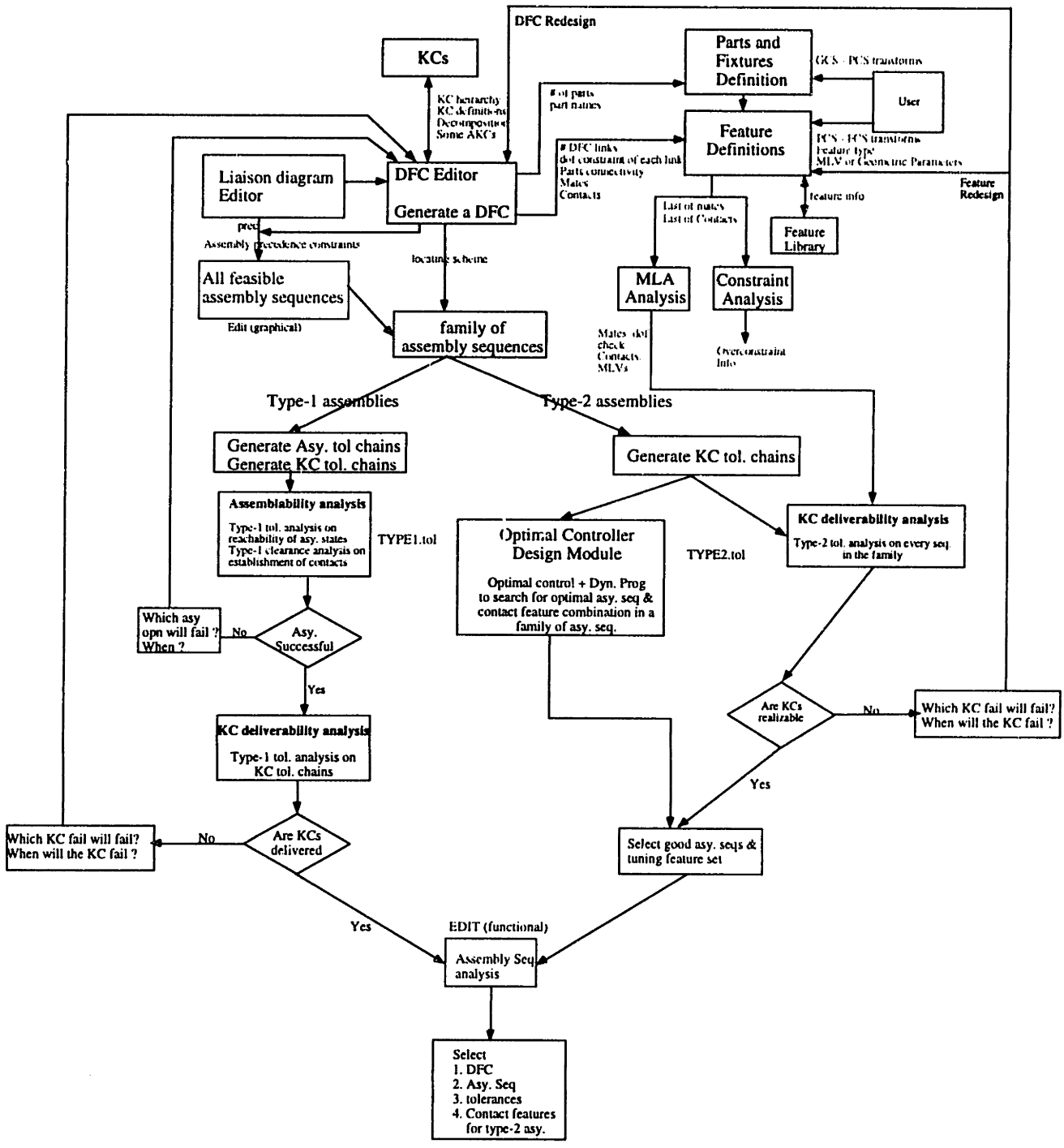

Figure 7-1: A flowchart of the Assembly Oriented Design system

7.3 System Structure

7.3.1 DFC Editor

This is an interactive conceptual CAD tool that provides the front end of the AOD system and integrates the different modules. It has a graphical user interface that lets the designer interactively construct the DFC and liaison diagram for the assembly in the same session. The constructed DFC can be checked for violation of any DFC properties by performing consistency checks. These checks include detection of loops, presence of only one root node, over and under constraint, etc. The DFC editor will be linked to a program called MLA (Motion Limit Analysis) that will enable the designer to select and analyze feature sets to realize the mates and contacts. This program and its capabilities are described in the next section. MLA also allows the designer to perform constraint and motion limit analyses on these feature sets. These analyses verify if the selected mating features provide the intended constraint along the desired directions. The DFC editor also creates an assembly database where information about the DFC, liaison diagram and feature information is stored. The DFC editor is linked to the assembly sequence analysis (ASA) module. The different modules extract the necessary information directly from the assembly database. This enables generation of both the complete set and a family of assembly sequences of the assembly and DFC under design. The graphical user interface of the DFC editor is shown in Figure 7-2.

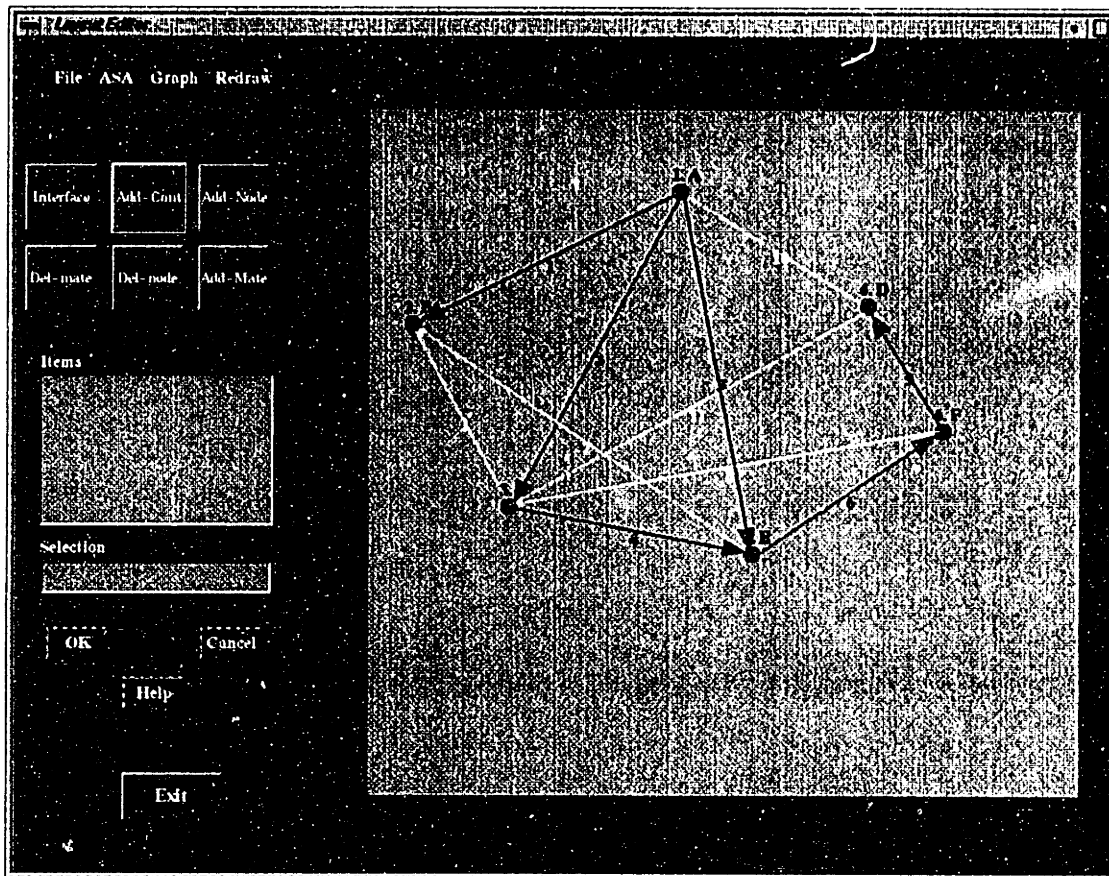

Figure 7-2: The interactive DFC editor

7.3.2 Motion limit analysis (MLA)

Motion Limit Analysis (MLA) is a tool used to support the top down design and analysis of assemblies. The purpose of MLA is to provide mathematical models of assembly features from which the ability of a feature to position one part relative to another in space can be calculated. A user of this theory is able to obtain three major types of information about an assembly:

Knowledge of the directions and quantitative amounts of possible part motions of a part that is being added to an assembly at a given assembly station via connection of a defined set of assembly features.

Knowledge of whether or not the defined feature set over-, under-, or fully-constrains the location and orientation of the part.

Knowledge that the defined feature set can establish the desired location of the part within the assembly it is being added to.

The theories of MLA have been implemented in a computer software program. The MLA software receives some input from the DFC editor and some input from the user. Basically, the DFC editor provides information about the parts and interconnections between parts in an assembly. The MLA software is then used to choose features that realize these interconnections and perform calculations about the properties of the chosen set of features. Using the MLA software, a user performs four basic steps:

Define the location and orientation in global coordinates of all parts in the assembly under study.
Choose assembly features to physically realize these connections between parts that are inferred from the DFC diagram of the assembly.

Define the location and orientation of these assembly features on each part.

Specify geometric parameters defining the feature, and/or specify numerical limits on the motions that each feature will allow acting individually.

The software first analyzes all mates in the assembly. The purpose of this analysis is to check if the mates do indeed constrain all six degrees of freedom of each part as intended. The mates are also checked to see if they over-constrain the parts. Over-constraint means that a given degree of freedom of a part is being controlled by more than one assembly feature. Next the contacts are analyzed. If the assembly feature accomplishing the contact, acting independently, would allow relative motion between the two parts it connects, the limits on this rigid body motion are calculated. These limits are provided as inputs to the Type-2 tolerance analysis routine as physical limits on positional adjustments that can be made to the parts at the assembly station where the contact corresponding to each vector of limits is made. The front end interface of this program is shown in Figure 7-3.

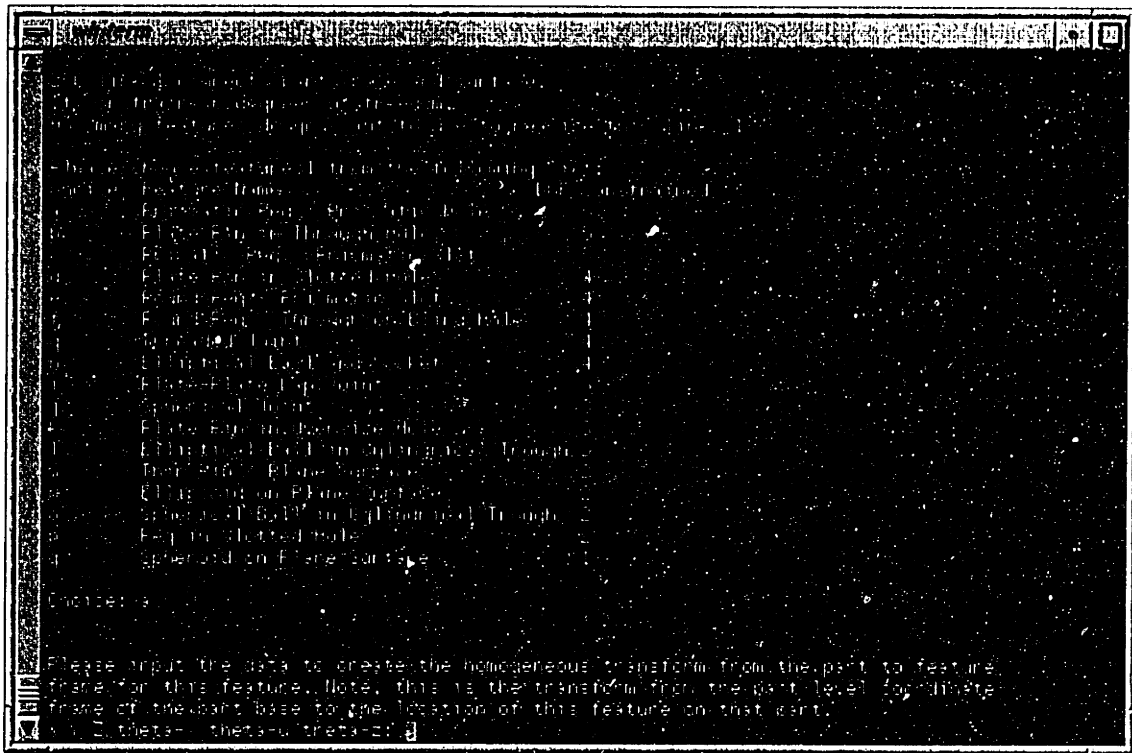

Figure 7-3: Graphical user interface of the MLA software

7.3.3 Assembly Sequence Analysis software (ASA)

This software refers to a suite of tools used to generate and evaluate assembly sequences. These tools can be used both as stand alone tools and integrated with the DFC editor. They are described as follows:

7.3.3.1 Assembly Sequence Generation

Assembly sequence generation involves first generating the assembly precedence constraints and then using the precedence constraints to generate the assembly sequences. Two types of precedence constraints are considered: geometric and DFC related.

7.3.3.1.1 Geometric Precedence Constraints (SPAS)

This software generates assembly precedence relations for the given assembly from the geometric constraints imposed by the shape and size of the different parts in the assembly. The analysis used to generate these precedence relations is based on a graphical representation of the contacts between parts called the "liaison diagram". Each node in the liaison diagram represents

a contact between parts. Three different algorithms have been implemented to generate all the possible assembly sequences. These algorithms are:

Modified Bourjault method (DeFazio, et al. 1987)

Cut-Set method (Baldwin 1989)

Onion-Skin method

The designer is presented with a series of queries to determine the ability to assemble or disassemble a part to/from an assembly, which are answered in Yes or No. These answers are processed by the computer to generate a list of precedence relations for the assembly that are used to generate the assembly sequence diagram. The inputs to program are as follows. A simple example assembly is used to illustrate the inputs.

The part drawing

A simple sketch of the assembly showing the general shape of the parts

The liaison diagram

The second input is information about the joints between parts in the assembly. As described in section 7.3.1, the user constructs the liaison diagram interactively using the DFC editor. The DFC editor stores the liaison diagram in assembly database. SPAS reads this information directly from the assembly database.

Geometric relationship information

The user has to specify the exact geometric relationship between parts to enable answering the queries for sequence generation.

Based on this information, assembly precedence constraints of the form

$$(i \ \& \ j) \geq (k \ \& \ l) ;$$

are generated. The operator " \geq " means "must precede or concur with". The above constraint is read as: liaison i and j must be completed before or concurrently with, completion of (both)

liaisons k and l (but not necessarily before or concurrently with either liaison k or l). A typical session of this program is illustrated in Figure 7-4:

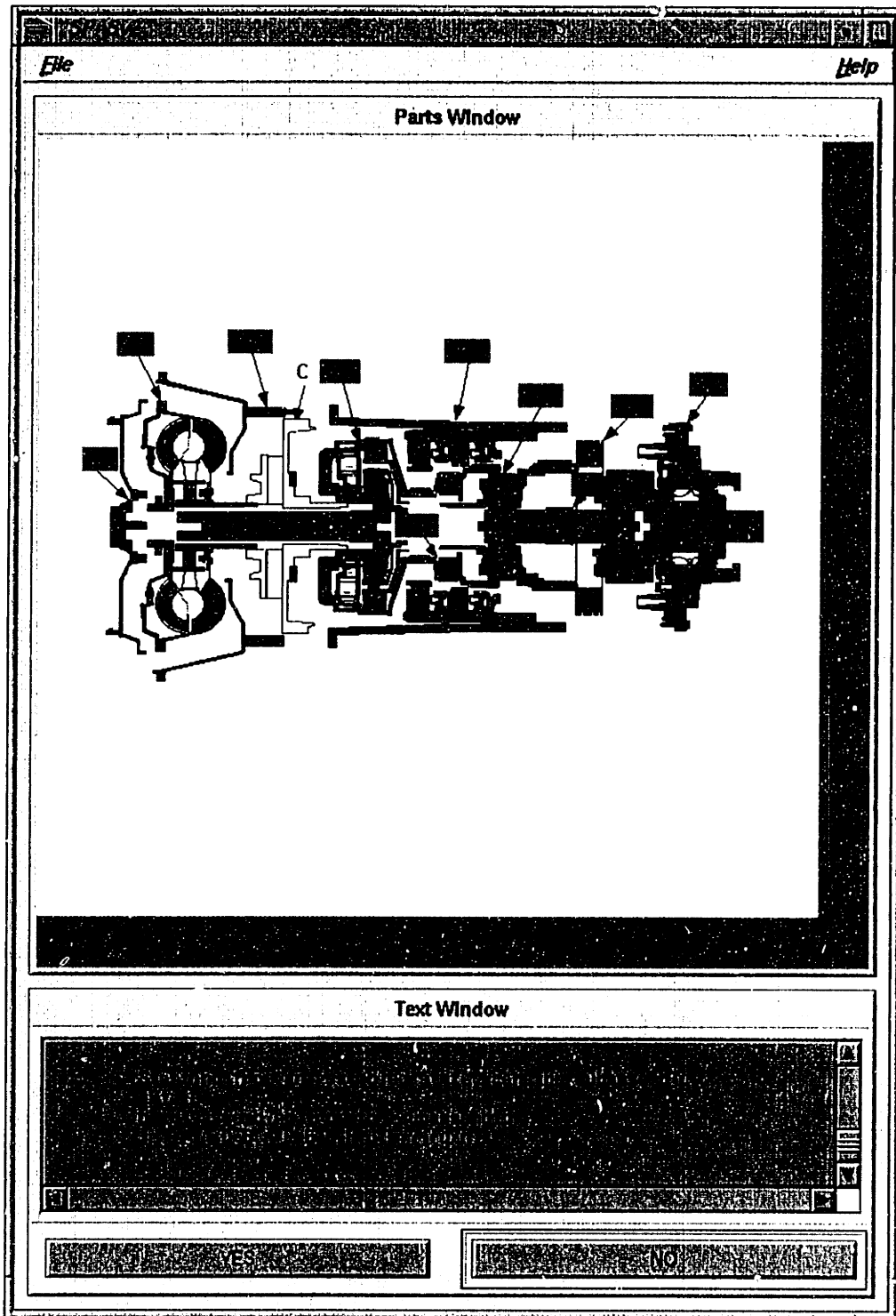

Figure 7-4: Graphical user interface of the SPAS software for generating geometric assembly precedence constraints

7.3.3.1.2 DFC Precedence Constraints (DFCPR)

A program called **DFCPR** takes the liaison diagram and the DFC under evaluation as inputs and applies the Contact and Constraint rule to generate a set of assembly precedence constraints. The liaison diagram and the DFC are represented using incidence matrices. The precedence constraints generated by DFCPR are of the same form as the geometric constraints described above.

These assembly precedence constraints are then used by another software program to generate the set of assembly sequences that is represented using an assembly sequence graph (Baldwin, et al. 1991). If only the geometric precedence constraints are fed to the program, an assembly sequence graph representing the complete set of assembly sequences is created. On the other hand, if both geometric and DFC precedence constraints are fed to the program, then an assembly graph representing only a family of assembly sequences for the DFC is generated.

7.3.3.2 *Assembly Sequence Evaluation (EDIT)*

A software program called **EDIT** represents the generated assembly sequence graph in a graphics window where the user can interactively query, inspect, evaluate and delete assembly states and transitions based on several criteria. This software gives the designer the ability to visualize the available assembly sequences. Editing based on conditions such as: deletion of moves where a particular set of liaisons are made, specification that a particular move must immediately precede another, subassemblies hard to assemble due to accessibility problems, etc. can be applied. These editing techniques quickly reduce the number of sequences to a handful that can be subject to more detailed analysis. More details about the capabilities and functions of the EDIT program can be found in (Baldwin, et al. 1991). A sample session is illustrated as follows in Figure 7-5:

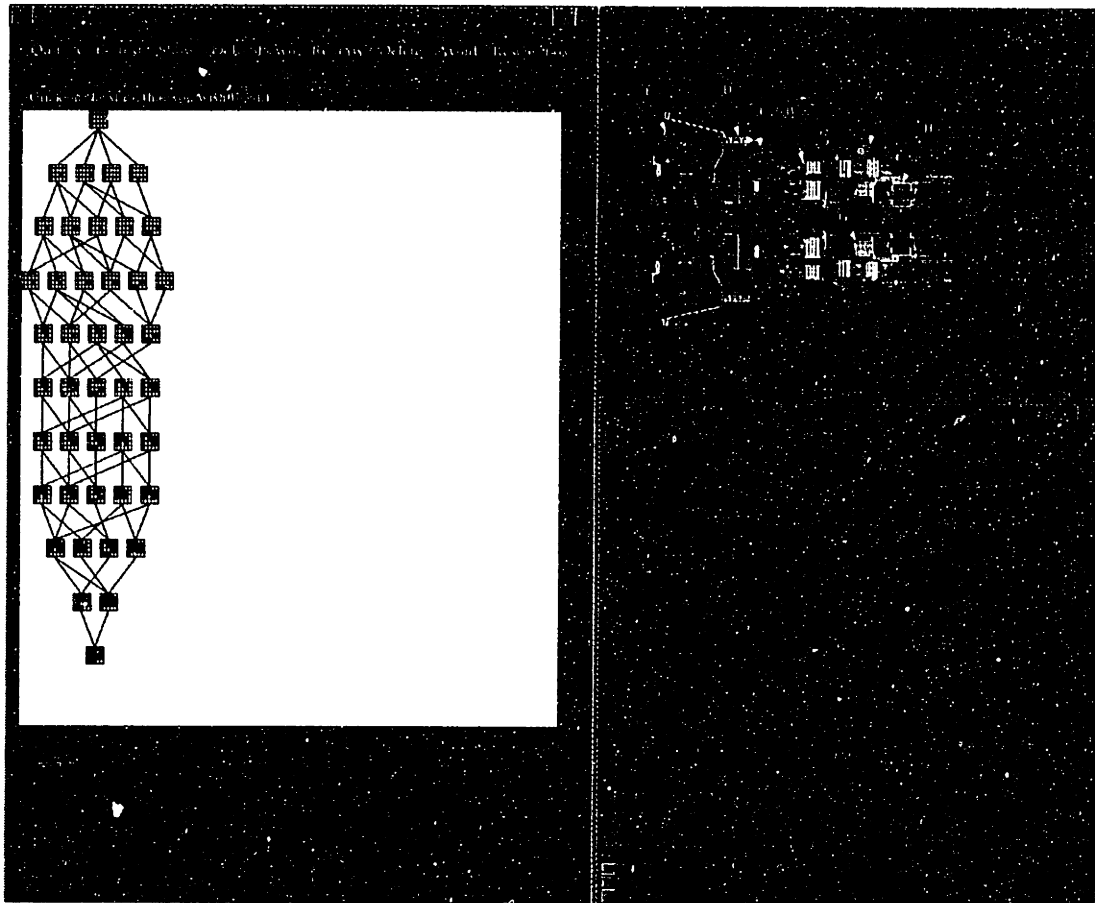

Figure 7-5: An interactive session with the EDIT software for evaluating assembly sequences

7.3.4 Control System Analyzer

The algorithms described in chapters 5 and 6 have been implemented as computer programs and can be used to evaluate assembly sequences and mating feature combinations. Two programs called TYPE1.tol and TYPE2.tol have been developed to study variation propagation in type-1 and type-2 assemblies and are described in sections 7.3.4.1 and 7.3.4.2. Interactive software implementation of the optimal controller design is described in 7.3.4.3. Currently these tools are developed as stand alone tools and require manual input to use them. In the future we foresee these tools being fully integrated within the AOD framework so that they can be used automatically by the DFC editor to analyze DFCs and assembly sequences.

7.3.4.1 Type-1 tolerance analysis module (TYPE1.tol)

TYPE1.tol is used to study variation propagation in type-1 assemblies. The input to the software is a tolerance chain for the KC that we wish to analyze. The inputs are currently provided interactively by the user and include nominal and variant transforms between coordinate frames on mating features on parts. The input and output information for this software are identical to that for TOLA which is described in (Gilbert 1992). We envision that the input information would eventually be extracted automatically from an assembly database for the design. The assembly database would have this information when the DFC and associated mating features describing the liaisons are designed. Currently the input window that takes this information interactively as shown in Figure 7-6.

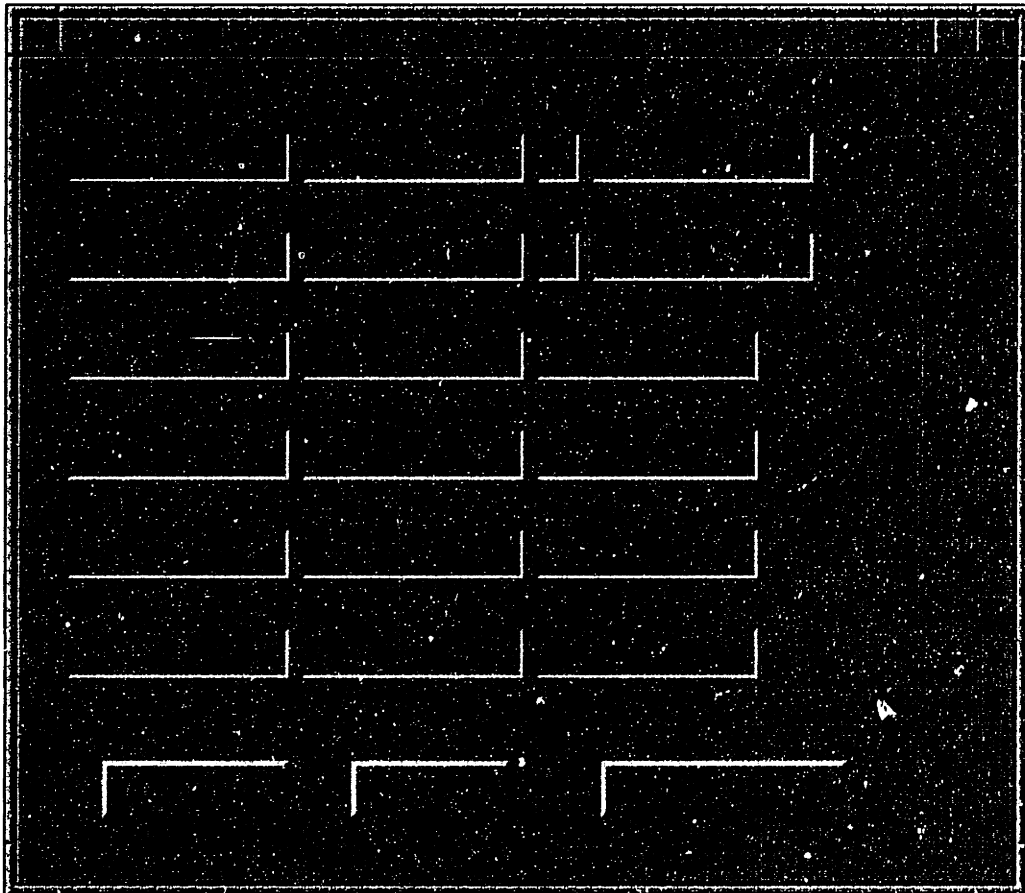

Figure 7-6: Graphical user interface of the input window that interactively takes information for every coordinate frame and provides it to TYPE1.tol

From the input information provided, the software computes the $A(k)$ and $F(k)$ matrices and computes the variation associated with the position and orientation of N^{th} frame with respect to the base frame. Covariance matrices for the position (V_p) and orientation vector (V_θ) are constructed and their Eigen values are computed to determine the resulting variation distribution. The Eigen values of the V_p covariance matrix are variances in the principal directions of the probability density ellipsoid. Standard deviations in each of the three principal directions are the square roots of the variances. The full lengths of these ellipsoids are equal to six times the standard deviation in the principal directions.

7.3.4.2 Type-2 tolerance analysis module (TYPE2.tol)

TYPE2.tol is a computer program that performs variation propagation analysis in the presence of a set of adjustments. It codes the algorithms described for type-2 assemblies in chapter 6. The inputs to this program are identical to those for TYPE1.tol except for the fact that the 6×1 adjustment vectors are also provided for each station. In places where adjustments are not possible a zero vector is input. At present, this information is provided manually by the user. In the future, we envision that the information can be accessed directly from the assembly database. The output from this program is identical to that of TYPE1.tol and is a description of the position and orientation error associated with the N^{th} frame.

7.3.4.3 Optimal Controller design module

The computer program to generate an optimal set of contact features for type-2 assemblies is developed as a part of TYPE2.tol. The inputs to this module are the same as that for TYPE2.tol except for the fact that no adjustment vectors \tilde{U} are provided as inputs. In addition the user interactively provides the $\mathbf{Q}(\mathbf{k})$, $\mathbf{R}(\mathbf{k})$, and $\mathbf{S}(\mathbf{N})$ weighting matrices to define the optimization function. The significance of these matrices was described in chapter 6. Based on the inputs and weighting matrices, the program computes an optimal set of \tilde{U} vectors which are to be interpreted by the user to design contact features. The program also determines the resulting variation distribution associated with the N^{th} frame given this set of optimal adjustments. An interactive session for the problem formulation #2 in chapter 6 is shown in Figure 7-7.

7.4 Design session

In this section we present a description of how we envision a designer would use AOD system. A step through the flow chart presented in Figure 7-1 is presented below:

1. The first step in the design process is the construction of the assembly's liaison diagram and DFC. A detailed flowdown of the key characteristics for the assembly is a pre-requisite for this operation. We assume that identification and classification of KCs is provided to us as input. Based on the KCs for the assembly, the designer interactively constructs a DFC and liaison diagram for the assembly using the DFC editor. The DFC editor creates an assembly database and stores information about the DFC and the liaison diagram for the assembly. Several types of consistency checks can be performed on the DFC created to verify if it satisfies all the properties of a DFC as described in section 7.3.1.
2. At present, we assume that the designer has rough sketches of the assembly to work with. In the future, we envision the DFC editor to be linked with a sketching CAD tool that will permit the designer to construct preliminary geometry of the parts in the assembly at an abstract level. This CAD tool will also be linked to MLA software described in 7.3.2. The next step is to design the mating features for the mates and contacts in the assembly. This is done using the MLA software. MLA reads information about the parts and fixtures, connectivity between parts, and DOFs constrained by mates directly from the assembly database. Using MLA the designer defines the features that constitute the mates and contacts for the assembly. Different kinds of analyses such as determination of over and under constraint conditions and motion limit analysis for contact features are performed using the MLA program. Motion limit analysis determines the absorption zone for every contact feature set in the assembly and stores them in the assembly database. For type-2 assemblies, these are the \tilde{U} vectors used by the TYPE2.tol to perform variation propagation analysis in the presence of adjustments.
3. The next step involves planning assembly sequences for the assembly. The DFC editor is used to spawn the ASA module to generate a complete set of assembly sequences for the

assembly. This is done by first executing SPAS to generate geometric precedence constraints and then using these constraints to generate the assembly sequence graph. The assembly sequences are visualized using EDIT. Next a family of assembly sequences is generated by first executing DFCPR and appending the DFC constraints generated by DFCPR to those generated by SPAS. This new set of constraints is used to generate a family of assembly sequences which is also visualized by EDIT. All these operations are fully integrated within the DFC editor framework.

4. The next step is to evaluate the family of assembly sequences. As described in chapter 4, the family can be evaluated using several criteria. The one of prime importance is variation propagation. For type-1 assemblies, TYPE1.tol is used to study variation propagation to address assemblability type problems. In type-1 assemblies all assembly sequences in a family of assembly sequences yield identical results in variation propagation analysis. Hence only one assembly sequence from the family need be analyzed to evaluate a complete family of sequences. As described in section 7.3.4.1, the inputs required for TYPE1.tol are the assembly tolerance chain and transform information. At present, TYPE1.tol runs as a stand alone piece of software and the user provides the input information interactively to perform the analysis. In the future, this program will be integrated to the DFC editor as most of the needed inputs already exist in the assembly database in one form or another.

For type-2 assemblies, TYPE2.tol is used to perform variation propagation in the presence of adjustments. Again, at present this program runs as stand-alone software. The inputs to this program are the same as those for TYPE1.tol except that the absorption zones of the various contact features also need to be provided. As described in section 7.3.2, this information is generated by the MLA software that determines the numerical limits on the motions that each contact feature will allow. Here different sequences within a family need to be evaluated with respect to each other for any given set of contact features.

5. For type-1 assemblies, based on the results obtained from TYPE1.tol, the designer may choose to redesign the elements of the DFC or tolerances on mating features. In the case of type-2 assemblies, the designer can choose to redesign the DFC, redistribute tolerances on

mating features or select an alternate set of contact features. The designer may also choose to run the optimal controller design module to design an optimal set of contact features that will repeatedly deliver the KCs.

6. The resulting family of assembly sequences and feature sets can then be evaluated for other assembly planning criteria such as desirable subassembly states, desirable assembly transitions, existence of multiple subassemblies, sequence of establishment of liaisons, etc. using the EDIT software.
7. The above process can be iterative and is performed until the designer is satisfied with the assembly design. At the end of the whole process, the designer will be left with a DFC for the assembly, a set of assembly features, a desirable assembly sequence and a measure of the probability of the design and assembly process delivering the KCs repeatedly.
8. For assemblies involving multiple assembly stations, a DFC is constructed for each assembly station. In such cases, the above seven steps are performed for each assembly station. The entire assembly process is thus modeled using a series of clusters of assembly operations as described in section 4.4.6.

7.5 Distributed design environment

With product development activity becoming increasingly global these days, there is a general shift towards network based design tools to permit dispersed teams to work together. We foresee that CAD tools in the future will be a lot more web based and network centric. Some of the applications described above have been developed to run under a distributed type of environment. The ASA software has been developed to use a WWW browser such as Netscape or Internet Explorer as a front end and can be used by remote users to analyze assemblies. This work was done as a part of the ACORN (Advanced Collaborative Open Resource Network) project. Server scripts were developed that fork these applications and present the user a form based environment to interactively generate, inspect, edit, and evaluate assembly sequences. The front-end interface developed to run EDIT on the World Wide Web is shown below in Figure 7-8.

Location: <http://cadlab.mit.edu/~krish/asmseq.html>

Assembly Sequence Graph

The following graph was created using the answers provided to the queries asked during precedence relation generation. The precedence relations generated form the input to another set of application software that generates this graph. The sequence graph consists of states and transitions which combine to form assembly sequences. The greatest gains in narrowing the choice of assembly sequences come from eliminating states. Lesser gains come from editing transitions, and still lesser gains come from editing actual assembly sequences. This is true because there are many more transitions than states in the assembly graph, and there are many more sequences than transitions, so if we eliminate a single state we will automatically eliminate at least a few transitions and many sequences. A variety of editing features based on assembly states and moves have been implemented. These are ...

Assembly Sequence Editing Criteria

- Undelete all states, expand graph.
- Eliminate Redundant States.
- Show State. (Click on the box whose state you wish to see).
- Show Transition.
- Delete State. (Click on the box representing the state you wish to delete)
- Delete Transition.
- *Editing States based on Multiple Subassemblies.*
 - Delete all states that have more than one subassembly.
 - Delete all states that do not have more than one subassembly (except first, second, and last nodes).
- *Editing states based on liaison establishment:*
 - Delete all transitions where a specified set of liaisons are made.
 - Specify that one liaison must immediately precede another.
- Resize Box.
- Quit.
- Window.

To see the edited graph, press: .

Click anywhere on the graph to proceed with the editing ...

Assembly Sequence Graph

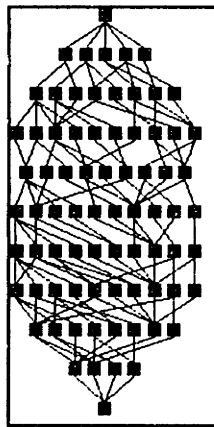

Figure 7-8: Assembly modeling services in a distributed web based environment

In future, we shall see the applications having a lot more web based content to make the Assembly Oriented Design environment a true distributed design environment so that dispersed teams can be involved in different aspects of the assembly design.

7.6 Summary

This chapter presented some of the software tools developed to implement some of the techniques presented in the previous chapters. The inputs, outputs and function of the tools and their interaction with other tools was presented. As mentioned at several places in the chapter, some of the tools are under development.

"If I have seen further, it is by standing on the shoulders of giants."

-- Isaac Newton

8.

Conclusions

8.1 Overview

This chapter summarizes the thesis and identifies major contributions made by this research work. Directions for future work and possible extensions to this research are presented towards the end of the chapter.

8.2 Summary of the thesis

In order to improve the efficiency of design activity, it is necessary to improve the performance of the design tools. A better understanding of the design methodology is required from which effective computer tools will emerge. The creation of new tools will eventually affect the current understanding of the design methodology. The goals of this thesis involved identifying new methodologies for conceptual design of assemblies and developing tools to implement these new theories.

A new approach to model assemblies and assembly processes has been developed. This approach enables the designers to foresee and handle potential problems pro-actively by performing

upstream design and analysis of candidate assembly processes. The concept of datum flow chain is introduced as a design tool to represent design intent and control the design of assembly processes. It enables the designers to explore the assembly and tolerance consequences of choosing among different locating schemes, feasible assembly sequences, choices of assembly mating features, and tolerances on the location and shape of these features. Two types of assemblies were identified and the need to differentiate between them was emphasized. Separate assembly modeling techniques were developed to address these two types of assemblies. Four classes of variation propagation problems were identified for these two types of assemblies. State transition models of assembly processes were developed as a unified framework to address these four classes of variation propagation problems. Concepts from control theory were applied to modeling assembly processes and designing assembly features between parts.

The tools and techniques developed as a part of this research were applied to several industrial strength problems. As described in chapter 4, two major assemblies were studied during the course of this research. Assembly of a 767 horizontal stabilizer assembly and assembly of fuselage sections of Boeing 777 airplane. These case studies demonstrated that DFC could be used to study existing processes and to develop new processes. In the case of 767 horizontal stabilizer assembly, the tool was first used to evaluate current practices and then to generate a new fixture-less assembly process. In the case of 777-fuselage section study, the DFC was used to identify inconsistencies in current design and assembly practices. It was used as a tool to monitor and evaluate locating and tooling plans at several assembly stations including assembly stations at supplier sites. Important sources of variation were identified and design and process changes were recommended to better control the assembly variation. The DFC is currently being used as a tool at Boeing to study assembly fit-up problems in other 777 assembly stations.

8.3 Major Contributions

This section summarizes the major contributions made by this research and highlights important findings.

8.3.1 Datum Flow Chain

The idea of the datum flow chain was introduced to capture design intent and provide a framework for top-down design of assemblies. The DFC emphasizes the need to distinguish between joints that transfer dimensional constraint from the ones that are redundant locationally and merely provide support once the parts are located. We call the joints that define location as mates and the redundant joints as contacts. This distinction is necessary to perform any kind of meaningful tolerance analysis, assembly sequence design and measurement plan design. Concepts from graph theory were used to define properties for the DFC and formalize its representation. These properties can be used to check for design consistency and identify major flaws in dimensional logic. The DFC can be used to plan subassemblies, create assembly procedures and design mating features to control variation during assembly and deliver KCs repeatedly. The DFC can be used as a monitoring tool to red flag assembly operations that attempt to absorb variation at mates. Mates are to be tightly controlled during an assembly process to consistently deliver the KCs.

8.3.2 Types of Assemblies

This thesis has identified for the first time two fundamental types of assemblies and has developed concepts and computational tools that model the design and assembly of these two types of assemblies. We call them type-1 and type-2 assemblies. Almost all research work on assembly modeling in the past has tried to apply the same general modeling methods to all types of assemblies without understanding the basic differences between them. As a result, there are some types of assembly fit-up problems that cannot be predicted and analyzed using such methods. The underlying issues during design and assembly planning are different for these two types of assemblies.

Type-1 assemblies are typical machined or molded parts that have mating features fully defined by their fabrication processes prior to final assembly. The mating features are almost always defined by the desired function of the assembly and the assembly process has little or no freedom in selecting mating features. Parts are located by other parts in the assembly and fixtures if present only support the parts being assembled. In type-1 assemblies, the variation in the final assembly is determined completely by the variation contributed by each part in the assembly. A

typical problem faced during assembly is not being able to assemble the parts due to interference. We call this an assemblability problem. In type-1 assemblies, all assembly sequences in a family have the same probability of delivering the KCs and hence only one sequence from each family need be analyzed for variation propagation.

Type-2 assemblies are assemblies that usually are given some or all of their assembly features or relative locations during assembly. Fixtures play a very important role in defining the relationships between parts. The final quality of the assembly depends crucially on the locating scheme, assembly sequence and choice of assembly features. Type-2 assemblies are interesting because they have parts with incomplete joints between them, which can be used intelligently to control variation distribution. The assembly process can redistribute variation based on in-process measurements. Assembly features can be designed specifically to suit assembly needs and promote selective propagation of variation. Traditional tolerance analysis algorithms cannot predict resulting variation distribution in such assemblies. This thesis developed new algorithms to study variation propagation in type-2 assemblies.

8.3.3 State Transition Models

A novel approach to modeling variation propagation in assemblies using state transition models was presented in this thesis. This approach allows for a common framework to address a broad range of variation propagation problems. It was shown that variation propagation along a KC chain can be modeled as a linear discrete event state transition system. Algorithms based on this theory were developed to model variation propagation and control for both type-1 and type-2 assemblies.

Modeling the assembly process using state transition models allows the application of control theory principles to analyze assembly problems. Concepts of controllability were used to determine the ability of a set of assembly features to control variation propagation in an assembly process. It was shown that the design of assembly features for type-2 assemblies can be modeled as designing optimal controllers for linear regulators. Generalized cost criteria were developed to incorporate design constraints into designing these features.

8.4 Recommendations for future work

8.4.1 Extension to Compliant Parts

Most of the ideas presented in this thesis apply primarily to assembly of rigid parts. The DFC attempts to locate the parts in a zero energy-stored state. Under such a situation, the mates define the location of every part in the assembly and are used to monitor the state of the KCs in the assembly. However if parts deform and store energy during assembly then the DFC loses its meaning. The DFC in such cases represents the as-fixtured condition where the parts have stored energy in them. Once the parts are released from the fixture, they assume a new configuration and it is impossible to distinguish between the mates and contacts under such conditions. Hence the DFC has no meaning under these situations. For this thesis, we had assumed all parts to be rigid and hence to be in zero energy state under all conditions. In type-2 assemblies where there were features such as slip planes that would absorb variation, the parts were also assumed to be always under zero stress.

However with slight modifications and extensions, some of the underlying principles can also be applied to compliant assemblies. If limits are specified on the amount of energy that is allowed to be stored in an assembly, relations can be developed between tolerances on parts, amount of energy stored and permissible strain in the assembly. These relations can be used in conjunction with the DFC to design assembly procedures for compliant parts. Variation absorption zones at contact features can be used to model the allowable ranges of deformation these compliant parts can undergo during assembly.

Recently, study of variation propagation in compliant assemblies has received a lot of attention. Assembly models of compliant assembly process have been developed by (Chang 1996), (Soman 1996), (Liu, et al. 1996), among others. The concept of the DFC and state models can be used in conjunction with some of these approaches to model compliant assembly processes.

8.4.2 Multiple KC chains

A typical assembly can have multiple KCs that have to be delivered upon final assembly. The assembly process delivers the KCs in a certain sequence. In some cases the KCs are coupled in

the sense that a single assembly operation might deliver more than one KC. This might not necessarily be undesirable unless the coupled KCs are conflicting. In such cases the downstream assembly operations lose certain degrees of freedom to their predecessors resulting in a “loss of quality” for the design solution from a downstream perspective. In some cases choice of a suitable assembly plan may de-couple the delivery of KCs. In certain other cases, choice of suitable assembly features such as slip planes can nullify the effect of the error caused by prior assembly operations. Hence by intelligent design of the hierarchy of location and mating features, some errors get propagated to the next assembly operation while others can be nullified.

Most of the analysis tools presented in this thesis model variation propagation along one KC chain at a time. These models can be extended to study the interaction between different KC chains as they grow during an assembly process. One way to monitor the interactions can be to compare the \tilde{U} vectors for the different chains at each assembly operation to see if they are conflicting. Such a type of analysis will be useful to plan assembly sequences and design assembly features for assemblies with multiple KCs that are coupled.

8.4.3 Design of Measurement Plans

In this thesis we presented the concept of datum flow chain to design a locating scheme for the assembly and the use of state space representations to determine if variation can be controlled during an assembly process. Concepts of controllability were used to determine the efficacy of assembly features to control variation during assembly. A parallel concept called the measurement flow chain (MFC) similar to the datum flow chain can be explored to design measurement schemes for assemblies. The use of the state space approach allows for the parallel concept of observability to be explored. This concept can be used to determine when and where to take measurements during an assembly process and if the designed measurement plan is truly indicating the state of the system. So the MFC and observability concepts can be used to design measurement schemes for assemblies just as DFC and controllability concepts were used to design locating schemes and assembly features.

8.4.4 Automated design of optimal assembly features

It was shown in Chapter 6 that optimal control theory can be applied to design an optimal set of assembly features in response to variation associated with different parts in the assembly. Given

the process capability information about the fabrication processes used to make individual parts, intelligent features can be designed to selectively propagate and control variation. The output from such an optimization procedure is a set of $\tilde{U}(k)$ vectors computed based on the choice of weighting functions and part variation distribution. Deriving mating feature sets from $\tilde{U}(k)$ is a one-to-many mapping problem as described in Chapter 6. Hence infinite combination of features and their placement on the parts exist for any given set of $\tilde{U}(k)$ vectors. In order to make the problem tractable, the optimization procedure can be made to search through a library of feasible feature sets to avoid unrealizable feature sets. A dynamic programming type approach can be applied to identify the optimal set of features from a library of existing feature sets. Future work involves developing mathematical models to address the inverse problem of converting the $\tilde{U}(k)$ s to realizable feature sets.

8.4.5 Integration of software tools

As described in chapter 7, the AOD flowchart is still evolving and requires manual input from designers at several points in the design cycle. In the future we shall see lot more integration between the different modules to permit a lot of seamless activity across the different modules. We also foresee the integration of the tools developed to a CAD system to visualize the assembly.

Bibliography

J. Gui and M. Mäntylä (1994). "Functional understanding of assembly modeling." CAD 26(6): 435-451.

J. Shah (1991). "Conceptual development of form features and feature modelers." Research in Engineering Design 2: 93-108.

J. J. Cunningham and J. R. Dixon (1988). Designing with features: the origin of features. 1988 ASME Computers in Engineering Conference, San Fransisco, ASME.

J. K. Gui (1993). Methodology for modeling complete product assemblies. Mathematics and Computer Science, Acta Polytechnica Scandinavica.

M. Mäntylä (1990). "A modeling system for top-down design of assembled products." IBM Journal of Research and Development 34(5): pp. 636-659.

NONAME (1981). Geometric Modeling Project. Description of NONAME: Geometric modeling, University of Leeds.

T. DeFazio, A. C. Edsall, R. E. Gustavson, J. A. Hernandez, P. M. Hutchins, H. W. Leung, S. C. Luby, R. W. Metzinger, J. L. Nevins, K. K. Tung and D. E. Whitney (1990). A Prototype for Feature-based Design for Assembly. ASME Design Automation Conference, Chicago.

R. J. Popplestone (1987). The Edinburgh designer system as a framework for robotics. IEEE international Conf. of Robotics and Automation.

R. Sodhi and J. Turner (1992). Towards a unified framework for assembly modeling in product design. Troy, NY, RPI.

K. Lee and D. Gossard (1985). "A hierarchical data structure for representing assemblies: part 1." CAD 17(1): 15-19.

K. Lee and G. Andrews (1985). "Inferencing of positions of components in an assembly: part 2." CAD 17(1): 20-24.

S. Srikanth, J. Turner and A. Sanderson (1991). Establishing part positions in assembly modeling, Product modeling for computer aided design and manufacturing. IFIP, North-Holland, Elsevier.

D. Rocheleau and K. Lee (1987). "System for interactive assembly modeling." CAD 19(2): 65-72.

U. Roy, P. Bannerjee and C. R. Liu (1989). "Design of an automated assembly environment." CAD 21(9): 561-569.

T. L. DeFazio and D. E. Whitney (1987). "Simplified generation of all mechanical assembly sequences." IEEE Journal of Robotics and Automation RA-3(6): 640-658.

L. H. D. Mello and A. Sanderson (1989). "A correct and complete algorithm for the generation of mechanical assembly sequences." IEEE Journal of Robotics and Automation: 56-61.

- H. Ko and K. Lee (1987). "Automatic assembling procedure generation from mating conditions." CAD **19**(1): 3-10.
- R. Wilson (1994). "Geometric Reasoning About Mechanical Assembly." Artificial Intelligence **71**(2): 371-396.
- D. F. Baldwin, T. E. Abell, M.-C. M. Lui, T. D. Fazio and D. Whitney (1991). "An Integrated Computer Aid for Generating and Evaluating Assembly Sequences for Mechanical Products." IEEE Transactions on Robotics and Automation **7**(1): 78-94.
- B. Romney, C. Godard, M. Goldwasser and G. Ramkumar (1995). An Efficient System for Geometric Assembly Sequence Generation and Evaluation. ASME International Computers in Engineering Conference, Boston.
- W. Hsu, C. S. G. Lee and S. F. Su (1993). "Feedback approach to design for assembly by evaluation of assembly plan." CAD **25**(7): 395-410.
- Y. F. Huang and C. S. G. Lee (1991). A framework of knowledge based assembly planning. IEEE Conf. on Robotics and Automation, Sacramento, CA.
- W. Eversheim and M. Baumann (1991). "Assembly-Oriented Design Process." Computers in Industry **17**: 287-300.
- D. J. Hart-Smith (1997). Interface Control-The Secret to Making DFMA Succeed. Society of Automotive Engineers.
- R. Mantripragada, T. Cunningham and D. E. Whitney (1996). Assembly Oriented Design: a new approach to designing assemblies. Product Modeling for Computer Integrated Design and Manufacture. M. J. Pratt and R. D. Sriram. 19-23 May, Airlie, Virginia, USA., Chapman & Hall: 308-324.
- S. Muske (1997). Application of Dimensional Management on 747 Fuselage. World Aviation Congress and Exposition, Anaheim, CA.
- K. W. Chase and A. R. Parkinson (1991). "A Survey of Research in the Application of Tolerance Analysis to the Design of Mechanical Assemblies." Research in Engineering Design **3**: 23-37.
- E. T. Fortini (1967). Dimensioning for interchangeable manufacture. New York, Industrial Press, Inc.
- O. Bjorke (1989). Computer-aided Tolerancing. New York, ASME Press.
- J. Turner (1993). Current Tolerancing Packages. International Forum on Dimensioning Tolerancing and Metrology, ASME.
- J. Turner (1990). "Relative Positioning of Parts in Assemblies using Mathematical Programming." Computer Aided Design **22**(7): 394-400.
- D. E. Whitney, O. L. Gilbert and M. Jastrzebski (1994). "Representation of Geometric Variations using Matrix Transforms for Statistical Tolerance Analysis in Assemblies." Research in Engineering Design **6**: 191-210.
- R. A. Moro (1994). A Systematic Approach to Design for Assembly: Feature Based Design and Tolerancing. MS Thesis, Aerospace and Mechanical Engineering. Boston, MA., Boston University.

- S. Lee, C. Yi and R. Suarez (1997). Assemblability analysis with adjusting cost evaluation based on tolerance and adjustability. IEEE International Conference on Robotics and Automation.
- A. C. Sanderson (1997). Assemblability based on Maximum Likelihood Configuration of Tolerances. IEEE Symposium on Assembly and Task Planning, Marina del Rey, CA.
- B. McCarragher (1996). "Task Primitives for the Discrete Event Modeling and Control of 6-DOF Assembly Tasks." IEEE Trans. on Robotics and Automation **12**(2): 280-289.
- R. Mantripragada and D. E. Whitney (1997). "State Transition Models of Mechanical Assembly Processes." Submitted to IEEE Trans. on Robotics and Automation.
- K. N. Otto and E. K. Antonsson (1993). "Tuning Parameters in Engineering Design." ASME Journal of Mechanical Design **115**(No. 1): 14-19.
- S. Soyucali and K. N. Otto (1997). Simultaneous Engineering of Quality Through Integrated Modeling. ASME Design for Manufacturing Conference, Sacramento, CA.
- K. Otto (1994). Robust Product Design using Manufacturing Adjustments. Design Theory and Methodology- DTM 94, ASME.
- R. Mantripragada and D. E. Whitney (1997). "Modeling and Controlling Variation Propagation in Mechanical Assemblies using State Transition Models." Submitted to IEEE Trans. on Robotics and Automation.
- S. Kalpakjian (1995). Manufacturing Engineering and Technology, Addison Wesley.
- M. Chang (1996). Modeling the Assembly of Compliant, Non-ideal Parts. Ph.D. Thesis, Dept. of Mechanical Engineering. Cambridge, MA, MIT.
- J. P. Koonmen (1994). Implementing Precision Assembly Techniques in the Commercial Aircraft Industry. MIT Sloan School of Management and Department of Aeronautics and Astronautics. Cambridge, MA, MIT.
- T. Cunningham, R. Mantripragada, D. Lee, A. Thornton and D. Whitney (1996). Definition, Analysis, and Planning of a Flexible Assembly Process. Japan/USA Symposium on Flexible Automation, Boston, USA., ASME.
- J. L. Nevins and D. E. Whitney (1989). Concurrent Design of Products and Processes. New York, McGraw-Hill.
- D. J. Lee and A. C. Thornton (1995). Key Characteristics for Agile Product Development and Manufacturing. Agility Forum 4th Annual Conference Proceedings.
- M. C. Y. Niu (1988). Aircraft Structural Design. Wanchai, Hong Kong., Conmil Press Ltd.
- L. S. H. D. Mello (1989). Task sequence planning for robotic assembly. Ph.D. dissertation, Electrical and Computer Science Dept. Pittsburgh, PA., Carnegie Mellon Univ.
- A. Bourjault (1984). Contribution a une approche methodologique del'assemblage automatise. Ph.D. dissertation, Universite de Franche-Comte.
- D. F. Baldwin (1989). Algorithmic methods and software tools for the generation of mechanical assembly sequences. S. M. Thesis, Mechanical Engineering. Cambridge, MIT.
- D. E. Whitney (1982). "Quasi-Static Assembly of Compliantly Supported Rigid Parts." Journal of Dynamic Systems, Measurement, and Control **104**: 65-77.

W. K. Veitschegger and C.-H. Wu (1986). "Robot Accuracy Analysis Based on Kinematics." IEEE Journal of Robotics and Automation **RA-2**(No. 3): 227-233.

M. Jastrzebski (1991). Software for Analysis of 3-D Statistical Tolerances Propagation in Assemblies Using Closed-Form Matrix Transforms. S.M. Thesis, Mechanical Engineering. Cambridge, MIT.

S. C. Liu and S. J. Hu (1996). "Tolerance analysis for sheet metal assemblies." J. of Mechanical Design **118**: 62-67.

A. Bryson and Y.-C. Ho (1975). Applied Optimal Control, John Wiley & Sons.

O. L. Gilbert (1992). Representation of Geometric Variations using Matrix Transforms for Statistical Tolerance Analysis in Assemblies. S. M. Thesis, Mechanical Engineering. Cambridge, MA, MIT.

H. Kwakernaak and R. Sivan (1972). Linear Optimal Control Systems, Wiley-Interscience.

N. Soman (1996). A Model of the Assembly of Compliant Parts. Ph.D. Thesis, Dept. of Mechanical Engineering. Cambridge, MA, MIT.